

PODIUM EDITION
BYLAWS AND RITUAL
2024



VETERANS OF FOREIGN WARS
OF THE UNITED STATES

AUXILIARY

AMERICANISM IS AN
unfailing love of country;
loyalty to its institutions and ideals;
eagerness to defend it against all enemies; undivided
allegiance to the flag;
and a desire to secure the blessings
of liberty to ourselves and posterity.

This definition of “Americanism” was promulgated by the Commanders in Chief of the Grand Army of the Republic, United Spanish War Veterans, Veterans of Foreign Wars of the United States, the National Commanders of the American Legion and the Disabled American Veterans of the World War at a conference held in Washington, in February 1927.

BYLAWS

Veterans of Foreign Wars of the United States

Auxiliary

A Missouri not-for-profit corporation

As Amended
July 26, 2023

As Amended
July 26, 2023

To Become Effective
August 25, 2023

Published at
NATIONAL HEADQUARTERS
KANSAS CITY, MISSOURI 64111

BYLAWS

TABLE OF CONTENTS

PREAMBLE	1
AUTHORIZATION	1
OBJECTS	2
ORGANIZATION	2
LEGAL DISCLAIMER	3
LANGUAGE PRESCRIBED	4
PROCEDURAL CHANGES	4
ARTICLE I MEMBERSHIP	5
Sec. 101—Eligibility.....	5
Sec. 102—Application—New Members	12
Sec. 103—Notification and Obligation	14
Sec. 104—Members in Good Standing.....	15
Sec. 105—Life Membership.....	16
Sec. 106—Transfers.....	17
Sec. 106A—Annual Transfer.....	17
Sec. 106B—Life Membership Transfer.....	18
Sec. 107—Membership—Widowers/Widows, Divorces/Divorcees Common Law Marriage and Same-Sex Marriage.....	19
Sec. 108—Removing Ineligibles.	19
Sec. 109—Members and Officers—Rights of.....	20
Sec. 110—Members At Large—Rights of	20
Sec. 111—Members—Rights of Appeal.....	21
Sec. 112—Visitations.....	21
Sec. 112A—Auxiliary Rights During Visitation.....	22
ARTICLE II AUXILIARIES	23
Sec. 201— Formation of Auxiliaries	23
Sec. 202—Jurisdiction by Posts	23
Sec. 203—Charter	23
Sec. 204—Institution.....	24
Sec. 205—Instituting Officer.....	25
Sec. 206—Consolidation of Auxiliaries.....	26
Sec. 207—Surrender or Forfeiture of Charter	26
Sec. 207A—Reactivation.....	27
Sec. 208—Disbandment	28
Sec. 208A—By Post	28
Sec. 208B—Auxiliary to a Disbanded Post.....	29
Sec. 209—Suspension/Cancellation by C-i-C & NP	29
Sec. 210—Meetings, Regular and Special.....	30

Sec. 211—Standing Rules.....	31
Sec. 212—Quorum.....	32
Sec. 213—Change of Location.....	32
Sec. 214—Change of Name.....	32

ARTICLE III AUXILIARY DELEGATES 33

Sec. 301—Eligibility.....	33
Sec. 302—District Meetings and Convention.....	33
Sec. 303—Department Meetings and Convention.....	33
Sec. 304—National Convention.....	35
Sec. 305—Delegates—Expenses.....	35
Sec. 306—Voting for Delegates.....	36
Sec. 307—Delegates—Credentials.....	36
Sec. 308—Arrearages Affecting Delegates.....	36

ARTICLE IV COUNTY COUNCILS (VFW ENDED IN 2022)

ARTICLE V DISTRICTS 38

Sec. 501—District Formation and Chartering.....	38
Sec. 502—District Governing Body.....	38
Sec. 503—District Composition.....	38
Sec. 504—District Meetings and Conventions.....	39
Sec. 505—District Standing Rules.....	40
Sec. 506—District Dues.....	40
Sec. 507—District Quorum.....	40
Sec. 508—Surrender, Forfeiture or Cancellation of a District Charter.....	40
Sec. 508A—Consolidated Districts.....	41
Sec. 508B—Auxiliary Not Affiliated with a District.....	41
Sec. 509—Suspension and Revocation of a District Charter.....	42
Sec. 510—District Reactivation.....	42
Sec. 511—District Arrearages.....	42

ARTICLE VI DEPARTMENTS 43

Sec. 601—Jurisdiction of Departments.....	43
Sec. 601A—Department Formation & Chartering.....	43
Sec. 602—Department Composition.....	43
Sec. 603—Department Meetings and Convention.....	44
Sec. 604—Department Quorum.....	44
Sec. 605—Department Bylaws.....	45
Sec. 605A—Department Standing Rules.....	45

Sec. 606—Department Committees.....	45
Sec. 606A—Credentials Committee	45
Sec. 606B—Resolutions Committee.....	46
Sec. 606C—Rules Committee.....	47
Sec. 606D—Program Committees.....	47
Sec. 606E—Audit Committee	47
Sec. 606F—Budget Committee.....	48
Sec. 607—Department Dues	49
Sec. 608—Department C of A, Composition and Duties..	49
Sec. 609—Department Official Visit.....	50
Sec. 610—Suspension or Revocation of a Department Charter	51
Sec. 611—Department Arrearages.	52

ARTICLE VII NATIONAL CONVENTION 53

Sec. 701—Supreme Body	53
Sec. 702—National Headquarters	53
Sec. 703—Composition.....	53
Sec. 704—Convention.....	53
Sec. 705—Quorum.....	53
Sec. 706—Standing Rules.....	54
Sec. 707—Disbursements.....	54
Sec. 708—National Dues.....	54
Sec. 709—Membership Dues Cards.....	54
Sec. 710—C of A, Composition and Duties	54
Sec. 711—National Committees/Meetings & Convention	56
Sec. 711A—Credentials Committee.....	56
Sec. 711B—Rules Committees.....	56
Sec. 711C—Bylaws & Resolutions Committee.....	56
Sec. 711D—Program Committees	56
Sec. 711E—Audit Committee.....	56
Sec. 711F—Budget Committee	57
Sec. 711G—Appeals and Grievances Committee.	57
Sec. 711H—Life Membership Committee	58
Sec. 712—Disposition of Property	58

ARTICLE VIII OFFICERS 59

Sec. 801—Eligibility.....	59
Sec. 802—Elective Officers.....	59
Sec. 803—Appointive Officers.....	60

Sec. 804—Election	60
Sec. 804A—Election - All Levels	60
Sec. 804B—Auxiliary	60
Sec. 804C—District.....	60
Sec. 804D—Department	60
Sec. 804E—National	61
Sec. 805—Voting.....	62
Sec. 806—Installation	63
Sec. 806A—Auxiliary Installation.....	63
Sec. 806B—District Installation	65
Sec. 806C—Department Installation.	65
Sec. 806D—National Installation.....	66
Sec. 807—Term of Office	66
Sec. 808—Past Officers	67
Sec. 809—Resignations.....	67
Sec. 809A—All Levels (Presidents & Vice-Presidents). ...	67
Sec. 809B—Auxiliaries.....	68
Sec. 809C—District.....	69
Sec. 809D—Department	69
Sec. 809E—National	70
Sec. 810—President, Duties of (All Levels)	71
Sec. 810A—Auxiliary President.....	71
Sec. 810B—District President	72
Sec. 810C—Department President	73
Sec. 810D—National President	74
Sec. 811—Vice-Presidents, Duties of.....	75
Sec. 812—Secretary, Duties of (All Levels).....	75
Sec. 812A—Auxiliary Secretary.	76
Sec. 812B—Department Secretary	77
Sec. 812C—National Secretary.	77
Sec. 813—Treasurer, Duties of (All Levels)	78
Sec. 813A—Auxiliary Treasurer.....	79
Sec. 813B—District Treasurer.....	80
Sec. 813C—Department Treasurer.....	80
Sec. 813D—National Treasurer.	84
Sec. 814—Trustees, Duties of (All Levels).....	86
Sec. 814A—Department Arrearages	88
Sec. 815—Chief of Staff, Duties of	88
Sec. 815A—Department	88
Sec. 815B—National	89
Sec. 816—Chaplain, Duties of	89

Sec. 817—Conductor, Duties of.....	89
Sec. 818—Guard, Duties of.....	89
Sec. 819—Patriotic Instructor, Duties of.....	89
Sec. 820—Color Bearers, Flag and Banner Bearers and POW/MIA Flag Bearer, Duties of.....	90
Sec. 821—Historian, Duties of.....	90
Sec. 822—Musician—Soloist, Duties of.....	90
Sec. 823—Assistant Secretary, Conductor, Guard, Musician & Soloist, Duties of.....	90

ARTICLE IX MISCELLANEOUS PROVISIONS 91

Sec. 901—Ritual and Bylaws, Distribution of.....	91
Sec. 902—Meeting Etiquette.....	91
Sec. 903—What May Be Published	91
Sec. 904—Relief Fund.	91
Sec. 905—VFW Nat’l. Home Funds, Soliciting for	92
Sec. 906—Official Visit.....	92
Sec. 907—Floor Work	92
Sec. 908—Children & Caregivers Attending Meetings...	92
Sec. 909—Donations—National	93
Sec. 910—Control of Mailing Lists.....	93
Sec. 911—Politics	93
Sec. 912—Titles of Address.....	93
Sec. 912A—Title of Department Officers.....	93
Sec. 913—Members.....	93
Sec. 914—Supplies and Equipment.....	93
Sec. 915—Solicitation of Funds	94
Sec. 916—Rules of Order.	94
Sec. 917—Incorporation	94
Sec. 917A—For Departments, Districts and/or Auxiliaries.....	94
Sec. 918—Construction.....	95
Sec. 919—Fiscal Year.	95

ARTICLE X—ORGANIZATIONAL IMAGE..... 96

Sec. 1001—Official Look	96
Sec. 1002—Past Officers’ Pins.	97
Sec. 1003—Auxiliary Emblem and Logo.....	97
Sec. 1004—Seals.....	98
Sec. 1004A—Auxiliary.....	98
Sec. 1004B—Districts	98

Sec. 1004C—Departments.....	98
Sec. 1004D—National.....	98
Sec. 1005—Official Name.....	99
Sec. 1006—Color of Units.....	99
ARTICLE XI DISCIPLINE.....	100
Sec. 1101—Discipline of Members.....	100
Sec. 1102—Offenses.....	100
Sec. 1103—Disciplinary Actions or Alternative Actions.....	101
Sec. 1104—Appeal.....	103
Sec. 1105—Suspension from Office.....	105
Sec. 1106—Prima Facie Case.....	106
Sec. 1107—Penalties.....	106
Sec. 1108—Administrative Actions.....	106
ARTICLE XII AMENDMENTS.....	107
Sec. 1201—Amendments—Bylaws.....	107
Sec. 1202—Amendments—Ritual.....	107
BOOKLET OF INSTRUCTIONS for DISCIPLINE & DISCIPLINARY ACTIONS.....	108
INDEX for BYLAWS.....	130

**Changes from the
2023 Podium Edition: Bylaws and Ritual
are noted by a double underline.**

PREAMBLE

We, fathers, mothers, husbands, wives, widowers, widows, brothers, sisters, sons, daughters, grandfathers, grandmothers, grandsons and granddaughters, who are not less than sixteen (16) years of age, of deceased or honorably discharged Officers or enlisted persons, who have served in the Armed Forces of the United States of America, whose service entitles them to membership in the Veterans of Foreign Wars (VFW) of the United States as specified by the laws governing eligibility in the VFW, and who are in possession of or entitled to an honorable discharge under authority of a Charter duly granted by the National Convention of the Veterans of Foreign Wars of the United States, do unite to establish a permanent organization.

AUTHORIZATION

“Be it known that, Pursuant to the Charter and the Rules and Regulations of the Veterans of Foreign Wars of the United States, and under authority of the National Convention, we hereby establish an incorporated membership association to be known as the Veterans of Foreign Wars of the United States Auxiliary whose objects shall be to promote a fraternal, patriotic, historical, charitable and educational spirit; to aid and assist the members of the Veterans of Foreign Wars of the United States and its members wherever possible; to maintain true allegiance to the Government of the United States of America, and fidelity to its Constitution and Laws; to foster true patriotism; and to maintain and extend the institutions of American Freedom. Such association shall consist of a National Association to be known as the National Convention of the Veterans of Foreign Wars of the United States Auxiliary. Authorized subordinate units to be known as Auxiliaries to such subordinate organizations of the Veterans of Foreign Wars of the United States shall promote the same. Said units shall be subject to the authority of the National Convention of the Veterans of Foreign Wars of the United States and under the control and supervision of the Commander-in-Chief and the National Council of Administration.”

OBJECTS

The objects of this organization shall be fraternal, patriotic, historical, charitable and educational; to assist the Posts and members thereof of the F, and its own members whenever possible; to maintain true allegiance to the Government of the United States of America and fidelity to its Constitution and Laws; to foster true patriotism; to maintain and extend the institutions of American freedom and equal rights and justice to all men and women; and to preserve and defend the United States of America from all her enemies.

ORGANIZATION

The several constituted bodies of this organization shall consist of:

1. Subordinate organizations to be known as “Veterans of Foreign Wars of the United States Auxiliary to _____ Post No. _____,” to be abbreviated as “VFW Auxiliary to _____ Post No. _____.”
2. District organizations to be known as “Veterans of Foreign Wars of the United States Auxiliary to District _____, Department of _____,” to be abbreviated as “VFW Auxiliary to District _____, Department of _____.”
3. State organizations to be known as the “Veterans of Foreign Wars of the United States Auxiliary Department of _____,” to be abbreviated as “VFW Auxiliary Department of _____.”
4. A National organization to be known as “Veterans of Foreign Wars of the United States Auxiliary National Convention,” to be abbreviated as “VFW Auxiliary National Convention.”

LEGAL DISCLAIMER

The Veterans of Foreign Wars of the United States Auxiliary shall not be responsible for the negligent or wrongful acts or omissions nor the contractual obligations or debts of any Auxiliary, District or Department nor for the negligent or wrongful acts or omissions or contractual obligations or debts of any activity, or organization sponsored, conducted or operated by for or in behalf of any Auxiliary, District or Department. Any activity or organization sponsored, conducted or operated by, for, or in behalf of an Auxiliary, District or Department shall be at all times under the direct control of such Auxiliary, District or Department and all funds derived therefrom shall be at all times under the direct control of such Auxiliary, District or Department.

The Veterans of Foreign Wars of the United States Auxiliary is a not for profit membership corporation chartered by the Veterans of Foreign Wars of the United States. Accordingly, the Veterans of Foreign Wars of the United States Auxiliary has issued charters to Auxiliaries, Districts and Departments. Pursuant to their charters, those organizations are bound to pursue the objects and abide by the Charter, Bylaws, and the laws and usages of the Veterans of Foreign Wars of the United States Auxiliary. However, each organization is a separate unincorporated association or corporation under the laws of the jurisdiction in which each is located.

The Veterans of Foreign Wars of the United States Auxiliary does not own an interest in any facility or fundraising activity operated by any such chartered organization or are such facilities or other fundraising activities operating for, or on behalf of, the Veterans of Foreign Wars of the United States Auxiliary. The Veterans of Foreign Wars of the United States Auxiliary does not derive any profit from such facilities or activities.

The Veterans of Foreign Wars of the United States Auxiliary does not lend money or extend credit to any chartered organization. It is in no manner responsible for the debts or any other liability incurred by any chartered organization or other fund-raising activity operated by it. As unincorporated associations or corporations, they are responsible for their own debts and liabilities. To the extent that the Veterans of Foreign Wars of the United States Auxiliary is threatened with or sustains damage arising from a debt or liability incurred by a chartered organization, the Veterans of Foreign Wars of the United States Auxiliary may seek to recover such damages and any costs and expenses incurred from such chartered organization or persons responsible for such debt or liability.

LANGUAGE PRESCRIBED

All Veterans of Foreign Wars Auxiliaries now or hereafter organized shall conduct their meetings in the English language unless authorized by a unanimous vote of the members present.

For ease of reading in these Bylaws the name “Veterans of Foreign Wars of the United States Auxiliary” shall be referred to as “Auxiliary” beginning with Article I.

PROCEDURAL CHANGES

Internal policy procedure is not necessary for inclusion in the National Bylaws.

Please note: The VFW voted in 2022 to no longer have County Councils. Therefore, all verbiage to County Council's has been removed from the Podium Book.

BYLAWS

ARTICLE I MEMBERSHIP

Sec. 101—Eligibility

Membership in the VFW Auxiliary shall be limited to:

Husbands/Wives	Fathers/Mothers	Sons/Daughters	Brothers/Sisters
Widowers/ Widows	Grandfathers/ Grandmothers	Grandsons/ Granddaughters	

of persons who were or are eligible for membership in the Veterans of Foreign Wars of the United States. They must also:

- A. Profess a belief in God
- B. Be not less than sixteen (16) years old.
- C. Any current VFW member or any person eligible to join the VFW shall not be eligible to join the Auxiliary.
- D. Women who joined the Auxiliary prior to August 21, 2015 who are current members or are eligible for membership in the VFW shall be eligible for the Auxiliary so long as their membership remains current.

VFW ELIGIBILITY GUIDE

The following is to be used as a guide in determining eligibility for membership, and is furnished as a matter of information concerning the periods during which eligible service occurred.

Eligibility for membership in the Veterans of Foreign Wars of the United States is based on:

- A. Honorable service in the Armed Forces of the United States performed by Officers or enlisted personnel
- B. Who have served in any foreign war, insurrection, or expedition, which service is recognized by the award of a campaign or service medal of the United States
- C. Who served in Korea as outlined in the following guide
- D. Who earned Hostile Fire or Imminent Danger Pay
- E. Persons still serving in the armed forces may be accepted for membership provided that they meet eligibility requirements.

Proof of service to establish eligibility for membership rests with the applicant.

The following is a guide in determining eligibility and may be updated by the VFW.

Campaign Medal	Military Service	Qualifying Dates
<u>Expeditionary</u>	Navy/Marine Corps	Feb 12, 1874 – Open
<u>Spanish Campaign</u>	Army Navy	May 11, 1898 – Aug. 16, 1898 Apr. 20, 1898 – Dec. 10, 1898
<u>Army of Cuba Occupation</u>	Army	Jul. 18, 1898 – May 20, 1902
<u>Army of Puerto Rico Occupation</u>	Army	Aug. 14, 1898 – Dec. 10, 1898
<u>Philippine Campaign</u>	Army Navy	Feb. 4, 1899 – Dec. 31, 1913 Feb. 4, 1899 – Sept. 15, 1906
<u>China Relief Expedition</u>	Army Navy	Jun. 20, 1900 – May 27, 1901 Apr. 5, 1900 – May 27, 1901
<u>Cuban Pacification</u>	Army Navy	Oct. 6, 1906 – Apr. 1, 1909 Sept. 12, 1906 – Apr. 1, 1909
<u>Mexican Service</u>	Army Navy	Apr. 12, 1911 – Jun. 16, 1919 Apr. 12, 1914 – Feb. 7, 1917
<u>First Nicaraguan Campaign</u>	Navy	Jul. 29, 1912 – Nov. 14, 1912
<u>Haitian Campaign</u>	Navy	Jul. 9, 1915 – Dec. 6, 1915 Apr. 1, 1919 – Jun. 15, 1920
<u>Dominican Campaign</u>	Navy	May 4, 1916 – Dec. 5, 1916
<u>World War I Victory</u> <i>(With battle or service clasp Navy incl. Siberia and European Russia)</i>	Army	Apr. 6, 1917 – Apr. 1, 1920 Apr. 6, 1917 – Mar. 30, 1920
<u>Army Occupation of Germany</u>	Army	Nov. 12, 1918 – Jul. 11, 1923
<u>Second Nicaraguan Campaign</u>	Navy	Aug. 27, 1926 – Jan. 2, 1933
<u>Yangtze Service</u>	Navy	Sept. 3, 1926 – Oct. 21, 1927 Mar. 1, 1930 – Dec. 31, 1932
<u>China Service</u>	Navy	Jul. 7, 1937 – Sept. 7, 1939 Sept. 2, 1945 – Apr. 1, 1957
<u>American Defense Service</u> <i>(with Foreign Service clasp)</i>	Army–Navy	Sept. 8, 1939 – Dec. 7, 1941

<u>European–African– Middle Eastern Campaign</u>	Army–Navy	Dec. 7, 1941 – Nov. 8, 1945
<u>American Campaign</u> <i>(30 consecutive or 60 non– consecutive days of duty outside continental limits of the U.S.)</i>	Army–Navy	Dec. 7, 1941 – Mar. 2, 1946
<u>Asiatic–Pacific Campaign</u>	Army–Navy	Dec. 7, 1941 – Mar. 2, 1946
<u>Army of Occupation</u> <i>(30 consecutive days of duty)</i>		
Italy		May 9, 1945 – Sept. 15, 1947
Germany (except West Berlin)		May 9, 1945 – May 5, 1955
Korea		Sept. 3, 1945 – Jun. 29, 1949
Japan		Sept. 3, 1945 – Apr. 27, 1952
Austria		May 9, 1945 – Jul. 27, 1955
Germany (West Berlin)		May 9, 1945 – Oct. 2, 1990
<u>Navy Occupation Service Medal</u>		
Italy		May 8, 1945 – Dec. 15, 1947
Trieste		May 8, 1945 – Oct. 26, 1954
Germany (except West Berlin)		May 8, 1945 – May 5, 1955
Austria		May 8, 1945 – Oct. 25, 1955
Asiatic Pacific		Sept. 2, 1945 – Apr. 27, 1952
<u>Korean Service Medal</u>		Jun. 27, 1950 – Jul. 27, 1954
<u>Navy and Marine Corps Expeditionary Medal</u>		
Cuban Military Operation		Jan. 3, 1961 – Oct. 23, 1962
Thailand Military Operation		May 16, 1962 – Aug. 10, 1962
Iranian, Yemen and Indian Ocean Operation		Dec. 8, 1978 – Jun. 6, 1979 Nov. 21, 1979 – Oct. 20, 1981
Lebanon		Aug. 20, 1982 – May 31, 1983
Libyan Expedition		Jan. 20, 1986 – Jun. 27, 1986
Persian Gulf		Feb. 1, 1987 – Jul. 23, 1987
Panama (<i>pre and post invasion</i>)		Apr. 1, 1988 – Dec. 19, 1989 Feb. 1, 1990 – Jun. 13, 1990

Operation Sharp Edge – Liberia	Aug. 5, 1990 – Feb. 21, 1991
Operation Distant Runner – Rwanda <i>(11th Marine Expeditionary Unit USS Peleliu)</i>	Apr. 7 – 18, 1994
<u>Vietnam Service Medal</u>	Jul. 4, 1965 – Mar. 28, 1973 Apr. 29–30, 1975
<u>Armed Forces Expeditionary Medal</u>	
Lebanon	Jul. 1, 1958 – Nov. 1, 1958
Taiwan Straits	Aug. 23, 1958 – Jan. 1, 1959
Quemoy and Matsu Islands	Aug. 23, 1958 – Jun. 1, 1963
Vietnam	Jul. 1, 1958 – Jul. 3, 1965
Congo	Jul. 14, 1960 – Sept. 1, 1962
Laos	Apr. 19, 1961 – Oct. 7, 1962
Berlin	Aug. 14, 1961 – Jun. 1, 1963
Cuba	Oct. 24, 1962 – Jun. 1, 1963
Congo	Nov. 23 – 27, 1964
Dominican Republic	Apr. 23, 1965 – Sept. 21, 1966
Korea	Oct. 1, 1966 – Jun. 30, 1974
Cambodia	Mar. 29, 1973 – Aug. 15, 1973
Thailand <i>(only those in direct support of Cambodia)</i>	Mar. 29, 1973 – Aug. 15, 1973
Operation Eagle Pull – Cambodia <i>(includes evacuation)</i>	Apr. 11 – 13, 1975
Operation Frequent Wind–Vietnam <i>(includes evacuation)</i>	Apr. 29 – 30, 1975
Mayaguez Operation	May 15, 1975
El Salvador	Jan. 1, 1981 – Feb. 1, 1992
Lebanon	Jun. 1, 1983 – Dec. 1, 1987
Operation Urgent Fury – Grenada	Oct. 23, 1983 – Nov. 21, 1983
Eldorado Canyon – Libya	Apr. 12 – 17, 1986

Operation Earnest Will – Persian Gulf <i>(only those participating in, or in direct support)</i>	Jul. 24, 1987 – Aug. 1, 1990
Operation Just Cause – Panama <i>(USS Vreeland & other SVS–designated aircrew mbrs. outside the Conus in direct support)</i>	Dec. 20, 1989 – Jan. 31, 1990
United Shield – Somalia	Dec. 5, 1992 – Mar. 31, 1995
Operation Restore Hope – Somalia	Dec. 5, 1992 – Mar. 31, 1995
Operation Uphold Democracy – Haiti	Sept. 16, 1994 – Mar. 31, 1995
Operation Joint Endeavor – Bosnia, <i>Croatia, the Adriatic Sea & airspace.</i>	Nov. 20, 1995 – Dec. 19, 1996
Operation Vigilant Sentinel – Iraq, <i>Saudi Arabia, Kuwait, & Persian Gulf.</i>	Dec. 1, 1995 – Feb.15, 1997
Operation Southern Watch – Iraq, <i>Saudi Arabia, Kuwait, Persian Gulf, Bahrain, Qatar, UAE, Oman, Gulf of Oman W of 62°E Long., Yemen, Egypt, & Jordan.</i>	Dec. 1, 1995 – Mar. 18, 2003
Operation Maritime Intercept – Iraq, <i>Saudi Arabia, Kuwait, Red Sea, Persian Gulf Gulf of Oman W of 62°E Long., Bahrain, Qatar, UAE, Oman, Yemen, Egypt, & Jordan.</i>	Dec. 1, 1995 – Mar. 18, 2003
Operation Joint Guard – Bosnia, <i>Croatia, Adriatic Sea & airspace.</i>	Dec. 20, 1996 – Jun. 20, 1998
Operation Northern Watch – Iraq, <i>Saudi Arabia, Kuwait, Persian Gulf W of 56°E Long., and Incirlik AB, Turkey (only pers. TDY to ONW)</i>	Jan. 1, 1997 – Mar. 18, 2003
Operation Joint Forge <i>Bosnia – Herzegovina, Croatia, Adriatic Sea at airspace.</i>	Jun. 21, 1998 – Mar. 23, 1999
Operation Desert Thunder – Iraq, <i>Saudi Arabia, Kuwait, Bahrain, Qatar, UAE, Oman, Yemen, Egypt, Jordan, Persian Gulf, Gulf of Oman, Red Sea support.</i>	Nov. 11, 1998 – Dec. 22, 1998
Operation Desert Fox – Iraq, <i>Saudi Arabia, Kuwait, Bahrain, Qatar, UAE, Oman, Yemen, Egypt, Jordan, Persian Gulf, Gulf of Oman, USN Red Sea support.</i>	Dec. 16, 1998 – Dec 22, 1998

Former Republic of Yugoslavia		Jan. 1, 2014 – Open
<u>Southwest Asia Service Medal</u>		
Operation Desert Shield/ Operation Desert Storm <i>(combat areas of operation only)</i>		Aug. 2, 1990 – Nov. 30, 1995
Personnel assigned to support units serving in Israel, Egypt, Turkey, Syria, Jordan		Jan. 17, 1991 – Apr. 11, 1991
<u>Kosovo Campaign Medal</u>		
Operation Allied Force – <i>Kosovo Air Campaign</i>		Mar. 24, 1999 – Jun. 10, 1999
Kosovo Defense Campaign – <i>Ground Action</i>		Jun. 11, 1999 – Dec. 31, 2013
<u>Combat Infantry Badge & Combat Medical Badge</u>	Army	Dec. 6, 1941 – Open
<u>Air Force Combat Action Medal</u>		Sept. 11, 2001 – Open
<u>Combat Action Ribbon</u>	Navy- Marine Coast Guard	Dec. 6, 1941 – Open Dec. 6, 1941 – April 30, 1975
<u>Coast Guard Combat Action Ribbon</u>	Coast Guard	May 1, 1975 – Open
<u>Combat Action Badge</u>	Army	Sept. 18, 2001 – Open
<u>SSBN Nuclear Deterrent Patrol Insignia</u>	Navy	Jan. 21, 1961 – Open
<u>Korea Duty</u>		Jun. 30, 1949 – Open
Service on the Korean Peninsula, its airspace and territorial waters (for 30 consecutive or 60 non-consecutive days of duty)		
<u>Korea Defense Service Medal</u>		Jul. 28, 1954 – Open
<u>Global War on Terrorism Expeditionary Medal</u>		Sept. 11, 2001 – Open
<u>Afghanistan Campaign Medal (ACM)</u>		Sept. 11, 2001 – Open
<u>Iraq Campaign Medal (ICM)</u>		Mar. 19, 2003 – Dec. 31, 2011
<u>Air Force Expeditionary Service Ribbon with Gold Border</u>		Apr. 2004 – Open
<u>Inherent Resolve Campaign Medal</u>		June 15, 2014- Open

Hostile Fire or Imminent Danger Pay

This information is to be used for guideline purposes only.

- A. Proof of eligibility furnished must be
 1. Separation Document or
 2. DD 214 reflecting campaign medal service to establish eligibility
 3. Service in Korea without the issuance of a campaign medal can be established with additional, support documentation.
 4. Hostile Fire or Imminent Danger Pay can be established with pay records.
 5. Other documents acceptable by VFW are also acceptable for Auxiliary eligibility.

Sec. 102—Application—New Members

- A. Every person desiring to join the VFW Auxiliary shall submit an application using the procedures outlined by Auxiliary National Headquarters.
- B. Membership in more than one (1) Auxiliary is prohibited. If a member is found to belong to more than one Auxiliary, the member shall choose which Auxiliary to remain in and surrender membership in any other Auxiliary. If the member does not make a choice within 30 days, the National President or designee shall assign the member to an Auxiliary.
- C. Application must be accompanied by:
 1. Proof of eligibility, which means:
 - a. Honorable service making them eligible to membership in the VFW
 - b. The person died in service making them eligible for the VFW
 2. Required membership dues (Annual or Life)
 3. Money shall be placed in the hands of the Treasurer.
- D. Applicants whose eligibility is already a member of that Post need not show proof of eligibility.
- E. Department Members At Large
 1. Anyone eligible for membership may become a Department Member At Large of the Department upon:
 - a. Submitting a completed application to the Department Treasurer
 - b. Proof of eligibility
 - c. Payment of dues (Annual or Life)
 - d. Admission fees in the amounts determined by the Department Council of Administration.
 2. The Department Treasurer shall transmit to the National Treasurer fifteen dollars (\$15.00) of the dues collected for each Member At Large effective July 1, 2024.
- F. National Members At Large
 1. Any person eligible may complete the online application and sign up as a National At Large Life or Annual Member. The following must be furnished before the National At Large Life or Annual membership card is forwarded to the new member:
 - a. A completed application
 - b. Proof of eligibility

- c. Payment of the annual dues of fifty dollars (\$50.00).
- G. Admission fee fixed by the Auxiliary to be paid when initially joining, which entitles each new member to:
 - a. A membership pin.
 - b. A copy of the current “Podium Edition Bylaws and Ritual” or have the choice to access behind MALTA login.
- H. Each Auxiliary shall fix the amount of annual dues to be charged each member, which:
 - 1. Shall never be less than the amount required to cover Department and National dues.
 - 2. Dues shall be paid annually in advance in accordance with the calendar year.
 - 3. No additional fees may be assessed.
 - 4. National records and dues covering the membership of the Auxiliary shall be in the hands of the National Treasurer by June 30 of each year.
 - 5. There will be no refund of annual dues.
- I. The application shall be presented at a regular meeting of the Auxiliary.
 - 1. On recommendation of an Auxiliary member in good standing or the VFW
 - 2. The member making the recommendation shall not be a member of the investigating committee.
 - 3. Each application shall be referred to a committee of three (3):
 - a. Appointed by the President.
 - í.* Investigating Committee can change meeting to meeting (not a standing committee), depending on who is in attendance.
 - íí.* The President shall never appoint themselves to the committee.
 - b. The committee shall make a careful investigation of the facts set forth in the application for eligibility.
 - c. The committee shall see proof of honorable service of the eligible veteran, unless they are a member of the VFW Post to which the applicant is applying for membership.
 - d. If there are questions or concerns the application shall be held until the next meeting.

- e. The signatures of at least two (2) persons who served on this committee are necessary.
- f. The Auxiliary shall not take action on the application until the investigating committee's recommendation to accept or reject based on eligibility is made to the Auxiliary.
- J. If an Auxiliary is on suspension, the Suspension Committee may be used to form a quorum for the purpose of voting in new members.
- K. After the recommendation of the investigating committee and before voting on the applicant, members will be given an opportunity to state their objection to the admission of the applicant.
 - 1. Should there be no objection, several applicants for membership may be grouped and accepted by voice vote.
 - 2. Upon the request of one (1) member, any applicant shall be voted on separately by written ballot.
 - 3. A majority of the votes cast shall decide acceptance or rejection of the applicant.
 - 4. In case of a tie vote, the President shall cast the deciding vote.
 - a. Provided the President has not previously voted.
 - 5. If the applicant is rejected, refer to Section 103.

Sec. 103—Notification and Obligation

- A. When an applicant has been accepted by vote of the Auxiliary,
 - 1. They shall be notified orally or in writing that their application has been accepted.
 - 2. The Auxiliary Secretary shall notify the newly accepted member to appear at a stated time to receive the optional ceremonial obligation.
 - a. In the event the newly accepted member has subscribed to the printed obligation on the application, they shall be considered a member in good standing as soon as accepted and shall thereafter be entitled to all the rights and privileges of a member including election to an office.
 - 3. If the applicant is obligated at any time after July 1, the dues paid shall be for the next succeeding calendar year.

4. The new member shall receive from the Auxiliary a membership pin.
- B. If an applicant is found ineligible or rejected,
 1. Admission fee and dues shall be returned.
 2. If the applicant was found ineligible, they can apply again at any time when proper eligibility is found.
 - a. The reason shall be noted in the minutes.
 3. If the applicant was rejected by vote, they shall not again be proposed for membership in the same Auxiliary for at least one (1) year after rejection.
 4. The Auxiliary Treasurer shall prepare a duplicate copy of the original application, writing across the top of both applications the word “REJECTED” and the date.
 5. The original shall be retained in the Auxiliary’s application file until the member has been deceased for a period of six (6) years or has reached 120 years of age.
 6. The duplicate is sent to the Department Treasurer.
- C. Processing Applications
 1. The Auxiliary Secretary shall give the original application to the Treasurer.
 2. The Treasurer will follow instructions outlined in the current Treasurer’s Guide.

Sec. 104—Members in Good Standing

- A. The membership year of the Auxiliary is from January 1 to December 31.
 1. A member who has paid their dues to December 31 is in good standing.
 2. A member ceases to be in good standing on January 1 immediately following the year for which dues have been paid.
 3. A member shall not again be in good standing until their dues have been paid for the current year.
 4. Continuous membership begins again upon payment of dues.
 5. Dues must be paid by June 30 to remain a continuous member.
 6. Prior year’s dues may not be paid after July 1.
 7. Any member who has not maintained continuous membership shall submit an application and be accepted in the same manner as a new member.
 - a. No admission fee shall be required.

8. Date of rejoin starts new continuous membership timeline.

Sec. 105—Life Membership

- A. Any person who is a member in good standing in the Auxiliary may become a Life Member
 1. By the payment of the proper fee to the Auxiliary Treasurer in accordance with a fee schedule as set forth by the Auxiliary Life Membership Committee.
 - a. Annual Members may apply online to become Life Members at vfwauxiliary.org.
 - b. Proof of eligibility does not have to again be shown.
 2. A new member joining may join as a Life Member:
 - a. Upon submission of Life Membership application
 - b. Accepted to membership in accordance with Section 102.
 - c. Payment of Life Membership fee.
 3. A former member otherwise eligible to rejoin may become a Life Member upon acceptance to membership in accordance with Section 104.
 - a. With submission of a Life Membership application
 - b. Payment of the proper Life Membership fee to the Auxiliary Treasurer.
 4. The Life Membership shall become effective immediately upon the receipt of the fee.
 5. A Life Membership may be purchased as a gift.
 - a. In that case, the Auxiliary membership card will be sent to the Auxiliary Treasurer.
 6. Refunds: A Life Member who
 - a. Shall subsequently be found to be ineligible for membership shall forfeit their Life Membership, in which case, they shall be entitled to a proportionate refund of fees paid upon return of their Life Membership card to National Headquarters.
 - b. Becomes eligible for the VFW shall be entitled to a proportionate refund of fees paid by National Headquarters upon return of their Life Membership card to National Headquarters.
 - c. No refund of fees shall be made should a member be discharged from the organization by reason of Disciplinary Action.

- d. Voluntarily surrenders their Life Membership card shall also forfeit a refund of any fees.
7. The death of a Life Member following the issuing of the funds paying their per capita for the next calendar year to National Headquarters, the respective Department Treasurer and to their local Auxiliary shall not be cause for a refund of said per capita.
8. A Life Member shall not be subject to further membership dues levies of any kind and shall have all the benefits and privileges of the Auxiliary, Department and National membership as long as they shall live.

Sec. 106—Transfers

- A. Applicants who wish to transfer between Auxiliaries need not show proof of eligibility but instead must provide their current membership card as this proves eligibility has been established and approved with their current Auxiliary or as a Member At Large.

Sec. 106A—Annual Transfer

- A. Any member in good standing may transfer to any Auxiliary or to/from Member At Large
 1. **Upon presentation of a completed and executed application. Proof of eligibility is not required on an application to transfer. However, any membership may be challenged in accordance with Section 108.**
 2. Upon presentation of their current membership card.
 3. Upon payment of dues, if necessary.
 4. The member shall not be liable for admission fees.
 5. Upon acceptance or rejection by the Auxiliary of their choice, the Secretary shall notify the Applicant.
- B. The Auxiliary Secretary shall notify the Auxiliary from which the member transferred.
- C. The Auxiliary Treasurer will follow instructions provided in the current Treasurer's Guide.
- D. In order for the new Auxiliary to accurately maintain continuous membership records:
 1. It is the transferring member's responsibility to secure a statement from the Auxiliary in which they previously held membership.

2. The request may come from the member or the accepting Auxiliary.
 3. This statement must:
 - a. Advise that continuous membership was held at the time of transfer
 - b. Give the date of election to membership
 - c. Certify continuous years of membership
 - d. Be signed by the Auxiliary President and Treasurer.
- E. Non-paying transfer
1. Defined—Holds current year’s dues card.
 2. The accepting Auxiliary will not be liable for any dues on the transferring member. The member will be credited to the Auxiliary membership count for the purpose of representation in District, Department or National Conventions.
 3. The transferring member shall be entitled to all the rights and privileges of any other member in the accepting Auxiliary.
 4. The Auxiliary Secretary shall notify the Auxiliary from which the member transferred.
- F. Paying annual transfer
1. Defined—Belonged to another Auxiliary in the previous year and applies for transfer and pays current year’s dues to new Auxiliary.
 2. The accepting Auxiliary shall be liable for Department and National dues.
 3. A member requesting membership in any Auxiliary other than the Auxiliary in which they last paid dues shall present a regular application.
 - a. And be accepted by that Auxiliary.
 4. The Auxiliary Secretary shall notify the Auxiliary from which the member transferred.

Sec. 106B—Life Membership Transfer

- A. A member may be accepted as an Auxiliary Life Member Transfer in the same manner prescribed for an Annual member transfer.
- B. When a Life Member transfers:
 1. The Treasurer will follow instructions provided in the current Treasurer’s Guide.
 2. A new Life Membership Card showing membership in the new Auxiliary will be issued by National Headquarters.

**Sec. 107—Membership—Widowers/Widows, Divorces/
Divorcees, Common Law Marriage and Same-Sex Marriage**

- A. A widower/widow of an eligible veteran who is already a member of an Auxiliary is entitled to retain their membership even though they marry a person not eligible to the Veterans of Foreign Wars of the United States.
- B. A person who was widowed from an eligible veteran may join the Auxiliary even though they have remarried.
- C. A member who obtains a divorce shall not have their entitlement to membership questioned as long as they continue to be a member in good standing.
- D. A member who is separated by divorce from their spouse, under whose eligibility they entered the Auxiliary, and who is subsequently dropped from the rolls of membership for any reason recognized by these Bylaws, cannot re-enter the organization under said eligibility.
- E. A member who moves from a state that recognizes common law marriage to a state that does not shall not have their entitlement to membership questioned as long as they continue to be a member in good standing.
- F. Same-sex marriage became federal law in 2015.

Sec. 108—Removing Ineligibles

- A. An Auxiliary may, by motion duly passed at any regular or special meeting called for such purpose, question the eligibility of any member.
 - 1. The following shall be submitted through channels to the National President, who shall determine the eligibility of the member.
 - a. A copy of the member's application card.
 - b. A copy of the minutes of the meeting where the motion was taken to remove the member for ineligibility.
 - c. A copy of the proof of eligibility of the veteran under whom the member joined.
 - 2. Should the National President determine the member to be ineligible, they shall issue a special order directing that the member be removed from the membership rolls.
 - 3. A member remains a member until the special order is issued by the National President.
 - 4. Nothing in the Bylaws shall be construed as preventing the National President, upon their

own initiative and in the performance of their duty as otherwise prescribed, from enforcing the provisions of the National Charter and Bylaws regarding eligibility to membership.

B. The Auxiliary Secretary must notify the member of the vote of the Auxiliary to remove them for ineligibility.

1. The member will have 30 days to provide alternate proof of eligibility.

2. If no alternate eligibility is provided the Auxiliary Secretary must then send through channels, Auxiliary to Department and Department to National President. The National President shall then determine the eligibility of the member.

Sec. 109—Members and Officers—Rights of

A. No member shall be deprived of their rights and privileges as a member, except for nonpayment of dues, unless they shall have first been sentenced in accordance of Article XI of the National Bylaws.

B. No officer may be relieved of their office except for the following reasons:

1. Non-payment of dues prior to December 31. Once relieved from office, the member may not be re-elected or appointed to any position until the member's dues are paid.

2. Expiration of term of office

3. The office held has been declared vacant in accordance with Section 809 of the National Bylaws.

4. They have been sentenced in accordance with the provisions of Article XI of the National Bylaws.

Sec. 110—Members At Large—Rights of

A. Any Member At Large may

1. Visit Auxiliary, District, Department or National meetings, but is unable to enter into any discussion during the business session of these meetings.

2. Participate and volunteer in National Programs.

3. Receive a Cancer Grant, if eligible.

4. Purchase self-pay insurances and burial benefits.

5. Participate in member benefits received through the mail, e-mail or listed on the National website.

6. Have access to the VFW Auxiliary Magazine and E-Newsletter.

- B. Any Member At Large May Not
 - 1. Hold any office, chairmanship, be a VAVS representative or deputy, etc. at the Auxiliary, District, Department or National level.
 - 2. Be a Delegate to any District, Department or National Convention and therefore cannot vote.
 - a. A member of a disbanded Auxiliary shall have 30 days to transfer to another Auxiliary before being removed as any of the above.
 - 3. Qualify for certain group insurance plans.

Sec. 111—Members—Rights of Appeal

- A. Any member shall have the right to appeal through the proper channels.
 - 1. The actions of the Auxiliary or Auxiliary President, District or District President, to the Department President, Department Council of Administration, or Department Convention.
 - 2. To the National President, whose decision shall be final unless reversed by the National Council of Administration or the National Convention.
 - 3. All appealed decisions shall have full force and effect until reversed by proper authority, except appeals issued in accordance with Article XI of these Bylaws.
 - 4. Appeals of a decision shall be taken within thirty (30) calendar days of the date the decision was made. Decisions issued in accordance with Article XI of these Bylaws will follow Article XI.

Sec. 112—Visitations

- A. Any Auxiliary member visiting another Auxiliary or attending a District or Department meeting shall produce their current dues card.
- B. The visiting member, who is not a member of said Auxiliary, District or Department, shall not enter into the business of said body.
 - 1. The visiting member who is an official representative appointed by the Department President shall be allowed to speak and include, but are not limited to:
 - a. District President
 - b. Department Line Officer
 - c. Suspension/Mentoring Committee Members
 - 2. However, the official representative does not have the same rights as a member of the Auxiliary, i.e., voting or filling a position.

3. If you are visiting an Auxiliary while running for an office and you wish to speak, you should send a request in writing to the President prior to the meeting. If accepted, you may speak during the Good of the Order or when called upon by the President.
- C. Members At Large are considered visitors at any meeting they attend.

Sec. 112A–Auxiliary Rights During Visitations

- A. The Auxiliary President can request a visitor leave the room during private discussions, i.e., voting for applicants.
- B. The Auxiliary, District or Department President can remove visitors from the meeting if they try to interfere in Auxiliary business, unless they are requested to voice an opinion.
- C. If a visitor is barred/banned from the Post Home to which the Auxiliary is affiliated, the visitor can not visit the Auxiliary for the length of the barring/banning.

End of Article I.

ARTICLE II AUXILIARIES

Sec. 201—Formation of Auxiliaries

- A. Organized by authority of the National President
 1. Organizer shall be a member of the Veterans of Foreign Wars of the United States Auxiliary approved by the Department President.
 2. The President may also form an organizing team.
- B. Charter application of not less than fifteen (15) persons eligible to membership—(new or rejoined members)
- C. Transfers cannot be included on the charter application but may become Charter members following institution of the Auxiliary.
- D. The Department President shall appoint a three-person committee to be mentors for the newly formed Auxiliary for a period of at least one (1) full year. Two (2) of the three (3) should attend every meeting to offer guidance.
- E. No Auxiliary shall be recognized unless acting under a legal and un-forfeited Charter.

Sec. 202—Jurisdiction by Posts

- A. Per VFW Bylaws Section XI no Auxiliary to a Post of the Veterans of Foreign Wars of the United States shall be formed unless approved by a two-thirds (2/3) vote of the Post membership present and voting at a regular or special meeting, due notice of the proposed formation of an Auxiliary having been given the entire membership of the Post, in writing at least twenty (20) days prior to a regular meeting, or special meeting called for the aforementioned purpose.
- B. Each Auxiliary shall be assigned the name and number of the Post with which it is affiliated and subject to the jurisdiction of the Post whose name and number it bears.
- C. The Auxiliary shall be permitted to function in accordance with the National Ritual, Bylaws and Rules and Regulations of the Auxiliary and lawful orders issued by Department and National Officers of the Auxiliary.

Sec. 203—Charter

- A. The application for a Charter shall be made in writing on a form provided by National Headquarters.

1. It shall contain the name and number of the proposed Auxiliary and its location, which shall be the same as the name, number, and location of the Post with which it is affiliated.
- B. Upon signing an application for charter for a new Auxiliary, each prospective new member shall pay the admission fee and annual dues which shall not be less than the minimum amount required to cover admission fees and Department and National dues.
 1. Before obligation, each applicant shall execute and submit a completed application and pay dues in full as required for the current calendar year.
- C. Once the charter application is completed and signed by the Post Commander.
 1. It shall then be forwarded to the Department President for approval.
 2. The Department President shall forward the charter application and charter fee following procedures outlined in the Treasurer's Guide for approval of the National President.
- D. Charter fees as set by the National Treasurer and approved by the National Council of Administration will accompany the charter application.
 1. Payment must be made payable to "VFW Auxiliary."
- E. All Auxiliary Charters shall be signed by the National President countersigned by the National Secretary and bear the National Seal.
 1. When a Charter has been issued and signed by the National President, it shall not be changed or amended except in case of change of name, change of location or consolidation of Auxiliaries, as prescribed by the Bylaws.

Sec. 204—Institution

- A. Upon the authorization of a Charter to an Auxiliary, the Department President shall authorize the institution of said Auxiliary in accordance with the regulations and usages of this organization.
 1. The Department President shall designate the Instituting Officer, who shall make certain that the Officers of the new Auxiliary are instructed in their respective duties.
 2. Each new Auxiliary shall be instituted within sixty (60) calendar days of the date the Charter is authorized by the National President.

- a. National President may grant extensions requested for extenuating circumstances with reasons specified.
 - b. If not instituted within sixty (60) calendar days from date of authorization, said authorization may be rescinded, in which event the total charter fee shall be forfeited.
3. No Auxiliary shall be instituted with less than ten (10) eligible applicants present. Dues on at least fifteen (15) members must be paid and transmitted through the Department Treasurer to the National Treasurer.
 4. A meeting may be held immediately following the institution to:
 - a. Accept transfer members (who would then be eligible to be elected to office).
 - b. Set amount of annual dues amount.
 - c. Hold election of Officers
 - í. If a selection of Officers has been made prior to institution, such selection must be ratified at this meeting before the Officers are installed.
 5. Within forty-five (45) days of institution an Auxiliary will obtain a Federal Identification Number from the IRS and obtain a bank account in accordance with Section 813 of the Bylaws.
 - a. The Auxiliary will report their Federal Identification Number via form W-9 to National Headquarters and will report its bank routing and account numbers to National Headquarters via the ACH Authorization form or entered into MALTA.

Sec. 205—Instituting Officer

- A. Following institution of the Auxiliary, the Instituting Officer shall:
 1. See that the official Report of Institution and Report of Installation forms are completed and forwarded to the National Secretary and the Department Secretary.
 2. Assist the Auxiliary Treasurer in preparing the first transmittal for forwarding National and Department dues for each member as instructed by the National Treasurer to provide the information for the mailing list.
 3. See that a copy of each membership card is included for the Department Treasurer.

Sec. 206—Consolidation of Auxiliaries

- A. When two (2) or more Posts of the Veterans of Foreign Wars consolidate in accordance with Veterans of Foreign Wars National Bylaws, the Auxiliaries affiliated with these Posts shall be notified of said consolidation by the National Secretary.
 - 1. A special order shall be issued by the National President declaring the affected Auxiliaries are also consolidated and will now be known by the name and number designated by the Veterans of Foreign Wars National Organization.
 - 2. A joint meeting of the Auxiliaries shall be called no later than sixty (60) calendar days after receiving notification from the National Secretary to elect and install officers of the newly formed Auxiliary.
- B. The National President shall issue, without charge, a new Charter reciting the facts of such consolidation.
 - 1. The new Charter shall bear the same name and number of the consolidated Post.
 - 2. The new Charter shall be dated according to the muster date of the senior Auxiliary.
 - 3. The property of each of the Auxiliaries shall become the property of the Auxiliary as consolidated.
- C. In the event of two (2) or more Auxiliaries consolidating, all Officers of the consolidating Auxiliaries having fulfilled their obligations, shall be recognized as Past Officers.

Sec. 207—Surrender or Forfeiture of Charter

- A. An Auxiliary having less than ten (10) members in good standing on its rolls, upon recommendation of the Department President, shall surrender its Charter. However, if an Auxiliary has less than ten (10) members and are unable to get a quorum and are therefore unable to vote in new members, the Department President may authorize a suspension mentoring committee to investigate and accept potential new members or transfers to revitalize the Auxiliary. (This action can be ratified at the next Auxiliary meeting where a quorum is present.)
- B. No Charter shall be surrendered by any Auxiliary so long as
 - 1. Ten (10) members thereof demand its continuance;
 - 2. Unless a proposal to surrender the Charter shall have been made at a regular meeting of the Auxiliary at least one (1) month before the time of action.

- a. Notice of said proposal shall be given in writing to every member of the Auxiliary with copy of said notice mailed on the same date to the District, Department and National Presidents, and to the Post, District and Department Commanders no less than thirty (30) calendar days prior to the surrender or cancellation of the Charter. However, nothing herein is to prevent the operation of Section 206.
- C. On or after February 1 of the current year, the National President, upon recommendation of the Department President, shall declare an Auxiliary defunct and its Charter forfeited for failure or refusal to pay the Department and National dues on all its members in good standing as prescribed in these Bylaws, or for failure to pay Department and National dues on a minimum of ten (10) members.
- D. In case of surrender or forfeiture of a Charter, the Auxiliary may vote to dispense money as long as a quorum is present. Money may not be dispensed to individual Auxiliary members, however life memberships may be purchased. The other property of the Auxiliary, including books of record, original applications, papers and all remaining money belonging to it shall be turned over within thirty (30) calendar days to the Department President or their Representative for disposition as directed by the Department Council of Administration.
 1. The intent and purposes of trust funds or trust property or both shall be carried out to the extent of such property or funds.
 2. In the event of inability to satisfy the intent and purpose of the trust, the Department shall attempt to serve the trust and the best interests of the organization.

Sec. 207A—Reactivation

- A. A cancelled Auxiliary may be reactivated within one (1) year without submitting a Charter application if the cancellation was due to one (1) of the following:
 1. Failure to pay dues on ten (10) members
 2. Cancelled pursuant to Section 208B
 3. The Auxiliary voted to disband
- B. Requirements for reactivation:
 1. Recommendation by the Department President
 2. Recommendation by the Post Commander

3. Approval by the National President via special order of reactivation.
4. Department and National dues are paid on a minimum of ten (10) members who may be:
 - a. New members
 - b. Paying transfer members
 - í. Current paid members that were transferred to the Department Member At Large file due to the cancellation of the Auxiliary can apply for membership only after the ten (10) new or transferring member requirement has been met.
5. Must fulfill the requirements of a new Auxiliary within forty-five (45) days as per Section 204.

Sec. 208—Disbandment

Sec. 208A—By Post

- A. A Post may, by vote of eighty percent (80%) of its members present at a meeting following a printed or written notice, mailed or delivered to each member in good standing at least ten (10) calendar days before said meeting, vote to disband its Auxiliary; such notice to show contemplated action and the reason therefore.
 1. Following such action by a Post, the action shall be certified to and forwarded through channels to the Commander-in-Chief, who shall thereupon direct cancellation of the Charter of the Auxiliary only after an investigation by them that it is in the best interest of the organization to do so.
 2. An Auxiliary will not be considered cancelled until a special order is written by the National President.
- B. In case of cancellation of a Charter, the Auxiliary shall be given the opportunity to hold a meeting to finalize the business of the Auxiliary.
 1. After the order to cancel is issued
 - a. A final meeting is held
 - b. And the property of the Auxiliary including books of record, papers and all money, not voted by quorum to disburse, belonging to it shall be turned over to the Department President or their representative.
 - c. No money shall be disbursed to the Post that voted to disband them.
 - d. Members not transferring to another Auxiliary will become Department Members At Large

- e. The property shall then be turned over within thirty (30) calendar days to the Department Treasurer for disposition as directed by vote of the Department Council of Administration.
- C. A new Auxiliary to that Post cannot be organized for a period of one (1) year.

Sec. 208B—Auxiliary to a Disbanded Post

- A. The Auxiliary shall be canceled by the National President and shall be allowed sixty (60) calendar days to finalize its business.

Sec. 209—Suspension or Cancellation by Commander-in-Chief and the National President

- A. The Commander-in-Chief may direct the suspension or cancellation of the Charter of any Auxiliary upon recommendation of the Department Commander having jurisdiction when it is shown that the Auxiliary has become a detriment to the Post.
 - 1. While under suspension no meetings shall be held in the name of the Auxiliary or organization except for the sole purpose of the discussion of the cause, effect, or removal of penalty.
 - a. Membership dues should be continuously transmitted.
 - b. No other funds of the Auxiliary shall be expended or obligations incurred, except for the purpose of reinstatement from suspension during and while the order of suspension is in force and effect.
- B. The National President may suspend the Charter of an Auxiliary for a minimum of three regular meetings, for violation of the laws or usages of the organization or refusal to comply with lawful orders of the National Convention, National Council of Administration, or Department Council of Administration.
 - 1. If no appeal is taken within the period of sixty (60) calendar days, the Charter of the Auxiliary may be cancelled; provided, however, that before the Charter is cancelled, the Auxiliary in question shall have been duly notified in writing of the charges against it, and upon request shall have a suitable opportunity to appear or submit documentation before the National President or the National Council of Administration to show cause why its Charter should not be cancelled.
 - 2. While under suspension (but not one directed by the Commander-in-Chief), the business and affairs of

the Auxiliary may be carried on in a sphere limited to current activities (paying membership dues and other financial commitments already incurred and reinstatement from suspension) under a Department Committee.

3. The Department President shall establish this committee and shall grant it written powers and limitations.
 - a. It shall consist of at least three (3) members not to include the Department President or District President.
 - b. The committee attends the regular meetings of the Auxiliary.
 - i.* The District President may act as a liaison between the Auxiliary and Department President.
 - ii.* All acts and actions of the committee shall be subject to the approval or disapproval of the Department President, who, along with each committee member, shall submit to the National President, a monthly written report of the situation and the activities of the Auxiliary under suspension.
 - c. If the Auxiliary's suspension is lifted, the committee shall promptly end with a final report to the members of the Auxiliary at a regular meeting thereof.
 - d. If the Auxiliary Charter is finally revoked, the committee shall be utilized to finalize the business and affairs of the Auxiliary.

Sec. 210—Meetings, Regular and Special

- A. Monthly business meetings are encouraged, however every Auxiliary shall hold at least ten (10) business meetings per year.
- B. A change in the regular monthly business meeting date, time, or location shall be approved by a two-thirds (2/3) vote of the Auxiliary members present at such meeting.
 1. Notification of such change shall be sent to all of its Auxiliary members, the National, Department, and District Secretaries within ten (10) calendar days.
- C. The Auxiliary President may call a special meeting whenever, in their opinion, the same may be necessary for the welfare of the Auxiliary.

1. The Auxiliary President shall call a special meeting upon request, in writing, signed by five (5) members in good standing.
 2. The Auxiliary Secretary shall notify all members in writing of the time and place of any special meeting and of the business to be transacted, such notice to be sent at least forty-eight (48) hours in advance of the time set for the meeting.
 3. No business shall be transacted at any special meeting except that for which the meeting was called which was stipulated in the meeting notice.
- D. Video conferencing or teleconferencing is permitted for members unable to attend a meeting. Auxiliary to notify members by email at the beginning of the year if this vote passes.
- E. Video conferencing or teleconferencing when used to form a full quorum shall be utilized for extenuating circumstances to meet the required minimal ten meeting dates; or a member vote that needs immediate attention.
1. The Auxiliary Secretary shall designate in the minutes members attending by way of video conferencing or teleconferencing and ensuring that at least five (5) members in good standing are present by teleconferencing with mandatory attendance at the meeting site of at least the Auxiliary President and/or the designee if unable to attend; such as Senior Vice, Junior Vice, etc.
- F. If an entity on any level wishes to stream a meeting it must be done privately and not for public access.
- G. Individual members cannot record (video/audio) any portion of any Auxiliary, District, Department or National meeting without prior knowledge of the body.

Sec. 211—Standing Rules (Auxiliaries, Districts and Departments)

- A. Auxiliaries, Districts and Departments may establish Standing Rules to provide for specified operations, activities, events, expenses and disbursements between meetings provided such rules do not conflict with the National or Department Bylaws.
- B. Custom has the status of a Standing Rule. Standing Rules may be amended, modified, or rescinded at any meeting.

1. If prior notice is given, the vote is by majority vote of those members present.
 2. If previous notice is not given, the vote is by a two-thirds (2/3) vote of those members present. Standing Rules become effective immediately.
- C. A copy of the current Standing Rules must be included in the Secretary Book, and any time they are changed, rescinded or amended.

Sec. 212—Quorum

- A. Five (5) members in good standing of that Auxiliary shall constitute a quorum for the transaction of business at any meeting of that Auxiliary.

Sec. 213—Change of Location

- A. When a Post changes its official location from a community to another and makes the change in location on its Charter, the Auxiliary affiliated with such Post shall change its location to correspond to the location of the Post upon receipt of notice of such change from the National Secretary.
1. The Auxiliary Charter shall be changed to show the new location.
 2. A new Auxiliary Seal shall be purchased showing the new location.

Sec. 214—Change of Name

- A. An Auxiliary shall change its name to conform to the name of the Post at the first meeting following receipt of notice of change of name of the Post to which it is affiliated.
1. When an Auxiliary is notified by the National Secretary of change of name of the Post to which it is affiliated, the Auxiliary Charter shall be changed to the new name.
 2. A new Auxiliary Seal shall be purchased showing the new name.

End of Article II.

ARTICLE III AUXILIARY DELEGATES

Sec. 301—Eligibility

- A. Any member in good standing in their respective Auxiliary shall be eligible for election as a District, Department or National Delegate.
- B. Delegates and Alternates shall serve for one (1) full year from election to election.
- C. Delegates and Alternates shall function at the Convention and any Department Meeting where voting is called for following their election.
- D. Delegates and Alternates elected to District, Department and National Conventions shall be recognized only when Auxiliaries have conformed to the National Bylaws.

Sec. 302—District Meetings and Convention

- A. Delegates and Alternates to Districts shall be elected at a regular meeting of the Auxiliary held not less than ten (10) calendar days prior to the District Convention at which District Officers are to be elected
 1. One (1) Delegate and one (1) Alternate for each fifteen (15) members or fraction thereof in good standing in the Auxiliary at the time of the election of Delegates
 - a. Or as respective Department Bylaws may provide.
 2. The Auxiliary Secretary shall provide the names of the Delegates and Alternates to the District Secretary prior to the District Convention or as the District Standing Rules direct.
 3. Auxiliaries instituted subsequent to March 30 shall as promptly as possible elect Delegates and Alternates to the District Convention.
 4. The term of office for which Delegates are elected shall be for one (1) year from date of the election, as described in this Section, until the election of the new Delegates.

Sec. 303—Department Meetings and Convention

- A. Delegates and Alternates to the Departments shall be elected at a regular meeting of the Auxiliary held not less than thirty (30) calendar days prior to the Department Convention:
 1. One (1) Delegate and one (1) Alternate for each thirty (30) members or fraction thereof in good

standing in the Auxiliary at the time of the election of Delegates.

a. Or as the Department Bylaws provide.

2. The Auxiliary Secretary shall send the names of the Delegates and Alternates to the Department Secretary prior to the close of the credentials of the Department Convention.
3. Auxiliaries instituted during the thirty (30) calendar days prior to convening date of the Department Convention shall at the time of institution, or as soon thereafter as possible, elect Delegates and Alternates.
4. In the case of a new Auxiliary, within fifteen (15) calendar days following the date of institution.
 - a. The Delegate strength shall be based on the Department Treasurer's record as of the date of election of such Delegates.
5. The term of office for which Delegates are elected shall be for one (1) year from date of the election, as described in this Section, until the election of the new Delegates.

B. In Departments in which the Department Bylaws so provide, a delegate fee shall be paid by each Auxiliary for each and every Delegate to which the Auxiliary is entitled.

1. This fee must also be paid for each member included in the composition of the Department Convention to be allowed to vote.
2. The delegate fee shall be forwarded by each and every Auxiliary regardless of the number of Delegates present at the annual Department Convention and must be in the hands of the Department Treasurer not later than fifteen (15) calendar days before the convening of the Department Convention each year.
 - a. Auxiliaries failing to forward the full delegate fee shall be considered delinquent and in arrears.
3. However, all rights shall be restored promptly upon proper adjustment.
4. Members entitled to individual votes may pay the delegate fee at the Department Meeting.

C. The Department Treasurer shall set up a Department Convention fund line item in the Department budget.

1. All Department delegate fees received shall be placed therein and expended only for expenses incurred in the holding of an annual Department Convention.

- D. In Departments where a delegate fee is required:
1. The Auxiliary Secretary furnishes the Auxiliary Treasurer with a list of delegates,
 2. Who in turn forwards said list, together with the appropriate delegates' fee amount to the Department Treasurer.
 3. The Department Treasurer verifies that the number of delegates and the amount remitted agree.
 4. The Department Treasurer forwards the list of delegates to the Department Secretary.
 5. If the amount remitted does not agree, the Department Treasurer shall reconcile same with the Auxiliary Treasurer.

Sec. 304—National Convention

- A. Delegates and Alternates to the National Convention shall be elected at the last regular meeting in April;
1. One (1) Delegate and one (1) Alternate for each fifty (50) members or fraction thereof in good standing in the Auxiliary on March 31.
 2. The term of office for which Delegates are elected shall be for one (1) year from date of the election, as described in this Section, until the election of the new Delegates.
 3. The Auxiliary Secretary shall provide the names of the Delegates and Alternates to the National Secretary, along with their membership ID number, within thirty (30) calendar days of the date of election.
 4. Auxiliaries instituted or reactivated between April 30 and the date of the National Convention shall elect one (1) Delegate and one (1) Alternate for each fifty (50) members or fraction thereof for the National Convention based on the number of dues received by the National Treasurer at the time of election.

Sec. 305—Delegates—Expenses

- A. If a Delegate's expenses are to be paid:
1. A motion to do so shall be made before election.
 2. A paid Delegate is obligated to attend every business session of Conventions and make a report of same to their Auxiliary.

Sec. 306—Voting for Delegates

- A. Delegates and Alternates may be voted for on the same ticket:
 - 1. By the passage of a motion, so ordering, before voting commences
 - 2. The members receiving the highest number of votes shall be declared Delegates.
 - 3. Those receiving the next highest number of votes shall be declared Alternates.
 - 4. By passage of a motion, so ordering, before voting commences, Delegates and Alternates may be elected as nominated.

Sec. 307—Delegates—Credentials

- A. Delegates to National, Department and District shall be recognized with proper credentials
 - 1. The Auxiliary Secretary shall send or input electronically the names of the Delegates and Alternates to the respective Secretary within thirty (30) calendar days following election.

Sec. 308—Arrearages Affecting Delegates

- A. Any Auxiliary in arrears for District dues shall be deprived of Auxiliary representation at those meetings or Conventions for which the dues are in arrears.
- B. Any Auxiliary in arrears for the following shall be deprived of Auxiliary representation on all levels.
 - 1. Other financial obligations to National Headquarters
 - 2. Failing to have the office of the President and Treasurer bonded
 - 3. Failure to submit required quarterly audits (**Past four (4) consecutive audits due prior to the Convention.**)

End of Article III.

ARTICLE IV COUNTY COUNCILS

In 2023, the Veterans of Foreign Wars (VFW) of the United States voted to discontinue County Councils.

End of Article IV.

ARTICLE V DISTRICTS

Sec. 501—District Formation and Chartering

- A. Districts of the Auxiliary shall be identical in geographical limits with the respective Department Districts of the Veterans of Foreign Wars of the United States.
 - 1. To be known and identified by the same number.
 - 2. To be governed by and under the jurisdiction of the District whose number it bears.
- B. A Charter shall be issued by the National President to such Districts as determined by the Department Convention.
 - 1. The Charter shall be signed by the National President and countersigned by the National Secretary.
 - 2. The Charters are furnished upon request without charge from the National Secretary.

Sec. 502—District Governing Body

- A. Each District shall be governed by a District Convention
 - 1. Subordinate to the Department and National Conventions
 - 2. Under the jurisdiction of the VFW District

Sec. 503—District Composition

- A. The District Convention or meeting shall consist of:
 - 1. The National President and Past National Presidents, elected National Officers and the National Council Member, who are members in good standing in a Auxiliary within that District.
 - 2. The Department President and Past Department Presidents who are members in good standing in a Auxiliary in that District.
 - 3. The District President, all elective and appointive Officers of the District and all Past District Presidents who are members in good standing in Auxiliaries in that District.
 - a. However, if a Past District President transfers their membership to an Auxiliary in another District or Department, they are not entitled to a vote or recognition as a Past District President.

- b. Should there be a division, consolidation or elimination of a District or should any District's geographical boundaries be changed due to redistricting, any Past District President, who is a member in good standing in an Auxiliary within the geographical boundaries of the District from which they were elected and served to the end of their term as District President shall retain their title, recognition and any privilege they may otherwise be entitled to, including voting.
- 4. All Auxiliary Presidents throughout that District.
 - a. In the absence of the Auxiliary President, the Auxiliary Senior Vice-President, or in their absence, the Auxiliary Junior Vice-President, may function as a member of that District Convention or meetings.
- 5. Delegates to be elected by the Auxiliaries in that District.

Sec. 504—District Meetings and Conventions

- A. Each District shall hold an annual District Convention.
 - 1. The convention shall be held not less than ten (10) calendar days nor more than seventy-five (75) calendar days prior to the convening of the Department Convention
 - 2. To elect District Officers
 - 3. To transact business
- B. In addition, the District shall hold at least one (1) stated meeting each year for the purpose of conducting Schools of Instruction
 - 1. For Auxiliary Officers
 - 2. For the promotion of Auxiliary programs
- C. The District President may appoint such committee Chairmen as are required.
- D. Districts do not issue general orders or set up budgets.
- E. The District President may call other meetings when in their judgment it shall appear to be for the best interest of the members
 - 1. Or when instructed by a majority vote of the members present at a Convention or stated meeting.
 - 2. The District President shall instruct the District Secretary to notify all Auxiliary Presidents in writing of the time and place of any special meeting and of the business to be transacted.

Sec. 505— District Standing Rules

- A. Districts may establish Standing Rules to provide for specified operations, activities, events, expenses and disbursements allowable between meetings provided such rules do not conflict with the National or Department Bylaws.
 - 1. Custom has the status of a Standing Rule.
 - 2. Standing Rules may be amended, modified, or rescinded at any meeting.
 - 3. If prior notice is given, the vote is by majority vote of the Delegates present.
 - 4. If previous notice is not given, the vote is by a two-thirds (2/3) vote of the Delegates present.
 - 5. Standing Rules become effective immediately.

Sec. 506—District Dues

- A. Delegates assembled at a District Convention may assess annual dues not to exceed fifty cents (50¢) per member per Auxiliary
 - 1. Based on the June 30 membership of the preceding year.
 - 2. Dues cannot be assessed per Auxiliary on a flat rate basis.
 - 3. Dues should be remitted to the District Treasurer by September 30 of the current Auxiliary year or as established by the District Standing Rules.

Sec. 507—District Quorum

- A. The minimum number of Delegates required to constitute a quorum for the transaction of business at a District meeting or Convention shall not be less than Officers and/or Delegates representing one-fourth (1/4) of the Auxiliaries of the District.
 - 1. A minimum of five (5) members in good standing are required to constitute a quorum.
 - 2. For the purpose of this Section, the Auxiliary President shall be considered a Delegate.

Sec. 508—Surrender, Forfeiture or Cancellation of District Charter

- A. No Charter shall be surrendered by a District so long as two-thirds (2/3) of the Auxiliaries in the District affected demand its continuance.

1. Unless a proposal to surrender the Charter shall have been made at a stated or special meeting of the District,
 2. At least four (4) weeks before the convening of the District Convention
 3. Due notice of said proposal in writing given to every Auxiliary in said District and to the Department President.
 4. Districts who choose to surrender their charter lose representation on the Department Council of Administration.
- B. The Department Council of Administration must approve cancellation of a District Charter.
1. In case of surrender or forfeiture of a Charter the property of the District
 - a. Including books of record, papers and all moneys belonging to it,
 - b. Shall be turned over within thirty (30) calendar days following the issuance of the Special Order to the Department President or their Representative for disposition as directed by vote of the Department Council of Administration.

Sec. 508A—Consolidated Districts

- A. Upon the consolidation of two (2) or more Districts:
 1. New Officers shall be elected and installed.
 2. All Officers of the consolidating Districts having fulfilled their obligations shall be recognized as District Past Officers.
- B. A District with only one Auxiliary may remain a District provided they elect both District and Auxiliary officers, hold meetings separately, have separate financials, etc. This will preserve their right to representation on the Department Council of Administration.

Sec. 508B—Auxiliary Not Affiliated with a District

- A. If Auxiliary is **not** affiliated with a District they will not have representation on the Department Council of Administration with the exception of Departments without Districts.
- B. Any Auxiliary not affiliated with a District in a Department that has Districts will be known as unaffiliated Auxiliaries.

Sec. 509—Suspension and Revocation of District Charter

- A. A Department President may suspend the Charter of a District
 - 1. With the consent of the Department Council of Administration,
 - 2. For violation of the laws and usages of the organization.
 - 3. For refusal to comply with the lawful orders of the Department or National President.
- B. The President of the District in question shall be notified in writing by the Department Secretary
 - 1. Of the charges against it.
 - 2. Shall have an opportunity to appear before the Council of Administration to show cause why its charter should not be cancelled by the Department Convention.
- C. While under suspension
 - 1. No meeting shall be held in the name of the District or organization.
 - 2. Except for the sole purpose of discussion of cause, effect or removal of the penalty.
 - 3. No funds of the District shall be expended or obligation incurred during and while the order of suspension is in force and effect.
 - a. Except paying obligations already incurred and reinstatement from suspension.

Sec. 510—District Reactivation

- A. If the Charter of a District has been surrendered, forfeited or cancelled, then the District may be reactivated upon approval of the National President.
 - 1. There shall be no time limit on when a District may reactivate.

Sec. 511—District Arrearages

- A. If a District is in arrears for any of the following, the District President shall be deprived of their vote at the Department Convention:
 - 1. For any financial obligations to National Headquarters.
 - 2. For failure to bond the office of District President and Treasurer.
 - 3. For failure to submit accepted audits to the Department Treasurer within thirty (30) calendar days of each meeting (or quarterly, if monthly meetings are held).

End of Article V.

ARTICLE VI DEPARTMENTS

Sec. 601—Jurisdiction of Departments

- A. Each Department Auxiliary shall be
 - 1. Subordinate to, and under jurisdiction of the corresponding Department of the Veterans of Foreign Wars of the United States.
 - 2. New Departments of the Auxiliary shall be identical in geographical limits with the respective Departments of the Veterans of Foreign Wars of the United States.

Sec. 601A—Department Formation and Chartering

- A. A new Department may be formed by vote of the Auxiliaries in the geographic area of the Department, and there must be a minimum of three (3) Auxiliaries to establish a Department.
- B. New Departments of the Auxiliary shall be identical in geographical limits with the respective Departments of the Veterans of Foreign Wars of the United States.
 - 1. To be known and identified by the same name.
 - 2. To be governed by and under the jurisdiction of the Department whose name it bears.
- C. A Charter shall be issued by the National President to such Departments as determined by the National Convention.
 - 1. The Charter shall be signed by the National President and countersigned by the National Secretary.
 - 2. The Charters are furnished upon request by the National Secretary without charge.

Sec. 602—Department Composition

- A. A Department Convention shall consist of:
 - 1. The National President and Past National Presidents, elected National Officers and the National Council Member, who are members in good standing in an Auxiliary within the Department
 - 2. The Department President, and all Past Department Presidents, as long as they are a member in good standing in an Auxiliary in the Department of which they were President;
 - a. A Past Department President who transfers from the Department they served as Department President to another Department, is allowed to keep the status of a Past Department President

for recognition purposes only. They will not have voting rights as a Past Department President of their previous department.

3. All elective and appointive Officers of the Department, as listed in Section 802 and 803.
4. All District Presidents throughout the Department.
 - a. In the absence of the District President, the District Senior Vice–President or in their absence, the District Junior Vice–President, may be registered and function as a member of the Convention.
 - b. In the absence of the Auxiliary President, the Auxiliary Senior Vice–President, or in their absence, the Auxiliary Junior Vice–President, may be registered and function as a member of the Convention, but only one (1) Officer, in addition to Delegates, may represent any Auxiliary.
5. Delegates elected by the Auxiliaries.

Sec. 603—Department Meetings and Convention

- A. The stated meeting of the Department Convention of the Auxiliary shall be held in the same city on the same dates as the Department Convention of the Veterans of Foreign Wars of the United States.
- B. The Department shall be governed by the annual Department Convention subordinate to the National Convention.
- C. The Department President may call a special meeting when in their judgment it shall appear to be for the best interest of the members.
 1. The Department President shall instruct the Department Secretary to notify all members of the Council of Administration
 - a. Of the time and place of any special meeting
 - b. The business to be transacted

Sec. 604—Department Quorum

- A. The minimum number of Delegates required to constitute a quorum for the transaction of business at a Department Convention shall be not less than 40 percent of the Auxiliaries in the Department. Auxiliary members present count toward the quorum whether they are a Delegate or not. Only Delegates and voting members have the right to vote.

- B. If it is determined that a quorum is not present
 - 1. No principal or essential business can be transacted
 - 2. If such business is transacted, it is deemed illegal, null and void
 - a. Unless ratified or approved either later at the same meeting when there is a quorum, or at a subsequent meeting.

Sec. 605—Department Bylaws

- A. A Department Convention may adopt Bylaws not conflicting with the Bylaws or orders of the National Convention.
 - 1. May provide for the alteration or amendment thereof
 - 2. Two-thirds (2/3) vote of the Delegates is required for passage
 - 3. Provided two (2) copies of the proposed Bylaws are signed by the committee and the Department President
 - 4. Bylaws and amendments thereto must be printed in their entirety.
 - 5. Submitted to the National President within ten (10) calendar days after the Department Convention and once approved it will become effective.

Sec. 605A—Department Standing Rules

- A. Departments may establish Standing Rules
 - 1. To provide for specified operations, activities, events, allowable expenses and disbursement, and to allow electronic voting between meetings provided such rules do not conflict with the National or Department Bylaws.
 - 2. Custom has the status of a Standing Rule.
 - 3. Standing Rules may be amended, modified, or rescinded at any Council of Administration meeting.
 - 4. See Section 211.

Sec. 606—Department Committees (Meetings & Convention)

- A. The Department President shall appoint all Committees to include Credentials, Resolutions and Rules.

Sec. 606A—Department Credentials Committee

- A. The Credentials Committee

1. Shall consist of a Chairman and a minimum of two (2) members.
2. Shall examine the credentials.
3. Report to the Department Convention or designated Department Meeting the number of duly accredited Officers and Delegates present and entitled to vote.
4. The Department Treasurer and candidates running for office must not be appointed as members of this committee. If they have been previously appointed and decide to run for office they must resign from this committee.

Sec. 606B—Department Resolutions Committee

A. The Resolutions Committee

1. Shall consist of a Chairman and a minimum of two (2) members.
2. Shall receive all resolutions.
3. Shall present same with recommendations to the Department Convention or any Department Meeting for action.
4. Resolutions submitted by an Auxiliary for consideration at a Department Convention or Department Meeting must be signed in ink by the Auxiliary President.
5. Resolutions submitted by the Department Resolutions Committee for consideration at a Department Convention or Department Meeting must be signed by the members of the committee.
6. Resolutions submitted by the Officers of the Department for consideration at a Department Convention or Department Meeting must be signed by the officers.
7. If approved by the Department, the resolution must be postmarked or electronically sent (scanned or faxed) to National Headquarters.
 - a. Must include cover letter stating when the resolution was approved and that a quorum was present.
 - b. The letter must be signed by the Department President who presided at the Department Convention or Department Meeting.
 - c. Resolutions received after March 31 will be presented the following year.

8. Resolutions may be considered at any Department Meeting provided delegates are registered and permitted to vote.
9. A resolution that does not require National Convention action does not have to be forwarded to National Headquarters.

Sec. 606C—Department Rules Committee

- A. The Rules Committee
 1. Shall consist of a Chairman and a minimum of two (2) members.
 2. Shall recommend the rules for the guidance and orderly government of the convention.
 3. A copy shall be furnished to each Delegate.
 4. Adoption of the rules shall be the Convention's first business in order.

Sec. 606D—Department Program Committees

- A. The Department President shall appoint Program Committee Chairmen as determined by the National President.

Sec. 606E—Department Audit Committee

- A. The Department President shall appoint an Audit Committee.
 1. Consisting of a Chairman and a minimum of two (2) members of the Council of Administration or any Past Department President. This committee must not include the Budget Chairman, Secretary or Treasurer.
 2. It shall be the duty of the Audit Committee to properly audit the books and records of the Department Treasurer at least semi-annually and submit a report in writing of such audit to each member of the Council of Administration.
 3. The audit is read at the meeting following each audit.
 4. The Audit Committee shall certify by their signatures in the books that the books and records were found correct.
 5. Any negligence on the part of the committee in carrying out the mandates of this Section shall make this committee individually and collectively responsible, with any other, for any discrepancy.
 6. All audits must be accepted by motion.

7. An interim audit may be held as of April 30 prior to the Department Convention, covering that portion of the fiscal year.
8. The Committee, in addition to the foregoing, shall audit the records and accounts of all committees, Officers and members having to do with the receipt and expenditure of Department funds.
9. Perform such other duties incident to their office as the Department may direct.
10. A Certified Public Accountant (CPA) may be employed by the Department to audit the records of the Department Treasurer annually.
11. The Department Audit Committee shall review the CPA's report and present the report to the Council of Administration for approval.
12. The Department Audit Committee shall prepare and present to the Council of Administration the final audit report for the end of the fiscal year for approval. The report needs to include the governance letter or any recommendations and corrections that need to be adhered to.
13. A copy of the Council approved audit shall be signed by the committee and forwarded by the Department Treasurer to the National Treasurer by October 1, unless permission is granted by the National President for an extension.

Sec. 606F—Department Budget Committee

- A. The Budget Committee
 1. Shall consist of a Chairman and a minimum of two (2) members, appointed by the Department President
 2. The Budget Committee shall prepare a proposed budget from the tentative budget submitted by the Department Treasurer insuring it sets forth all estimated receipts and anticipated expenses for the financial operation of the Department for the ensuing year.
 3. The proposed budget shall be submitted in writing by the Chairman of the Budget Committee to the members of the Department Council of Administration for adoption at a stated Council of Administration meeting and when adopted the budget shall not be changed.
 4. It shall control expenditures of the Department,

unless otherwise provided by the Council of Administration

5. A copy of the Council approved budget shall be signed by the committee and forwarded to the National Treasurer by October 1.
 - a. Unless permission is granted by the National President for an extension.
6. The Budget Committee shall review the latest budget report prior to subsequent Council meetings and call to the Council's attention items that may need action.
7. Once the Council of Administration approves/adopts the budget it cannot be changed.

Sec. 607—Department Dues

- A. Department dues shall be established on each member in every Auxiliary only at the Department Convention.
 1. Department cannot levy any other compulsory dues.

Sec. 608—Department Council of Administration, Composition and Duties

- A. The Council of Administration of a Department shall consist of the President, Senior Vice-President, Junior Vice-President, Treasurer, Secretary, Chaplain, Conductor, Guard, Chief of Staff and District Presidents.
 1. In the absence of a District President, the District Senior Vice-President, or, in their absence, the District Junior Vice-President, may function as a member of the Council of Administration.
- B. In the event a Department does not have Districts the Presidents of all Auxiliaries in good standing shall be voting members of the Department Council of Administration.
 1. In the absence of the Auxiliary President, the Auxiliary Senior Vice-President, or in their absence, the Auxiliary Junior Vice-President may function as a member of the Council of Administration.
- C. The four (4) Junior Past Department Presidents, whose term on the Council of Administration shall not exceed four (4) calendar years from the year that their term as Department President ends, and all Past National Presidents, elected National Officers and the National Council Member shall be members of the Department Council of Administration in their own Department.

1. So long as they are members in good standing in an Auxiliary within the Department.
 2. In the event of the death of a Junior Past Department President, they are not replaced on the Council of Administration.
 3. In the event a Junior Past Department President is installed to another position on the Council, that Junior Past Department President seat remains vacant for that year.
- D. The Council of Administration shall meet at such time and place as may be determined by the Department Convention
1. At such other times and places as the President of the Department may order.
 2. As may be provided by a majority vote of the Council of Administration.
 - a. The Department Secretary shall notify all members of the Council of Administration of the date, time, place, and business to be transacted.
- E. Each member of the Council present at the meeting shall have one (1) vote.
1. A quorum for the transaction of business at a Council of Administration meeting in Departments without Districts shall not be less than one-fourth (1/4) of the Department Council Members of that Department present.
 2. A quorum for the transaction of business at a Council of Administration meeting in Departments with Districts shall be a majority of the Department Council Members of that Department.
- F. The Council shall
1. Approve the Department budget
 2. Approve the audit of the Auditing Committee
 3. Propose and approve expenditures outside Department Standing Rules, Budget and Bylaws shall represent, in all matters in the interval between its sessions, the Department Conventions.

Sec. 609—Department Official Visit

- A. The Department President may request further examination of any Auxiliary, its records and property whenever it is felt the good of the order demands it.

- B. The District Presidents shall have charge of and supervise the work of the annual visit of Auxiliaries in their Districts.
 - 1. For this purpose, the District President may appoint members to assist in this work. You may not do the official visit for your own Auxiliary or District.
 - 2. Said appointment subject to the approval of the Department President. (This could be the District Senior Vice-President, Junior Vice-President or any person who has held the office of District President or higher office.)
- C. In the event a Department does not have Districts, or an Auxiliary does not belong to a District, the Department President shall have charge of and supervise the work of the annual visits to Auxiliaries.
- D. The District President or the Department President in Departments where there are no Districts shall not conduct an official visit of their own Auxiliary, nor shall a member of their Auxiliary.

Sec. 610—Suspension or Revocation of Charter of a Department

- A. The National President may suspend the Charter of a Department for a period of thirty (30) calendar days for
 - 1. Violation of the laws or usages of the organization
 - 2. Refusal to comply with lawful orders of the National President, National Council of Administration, or National Convention.
- B. If no appeal is taken within the period of thirty (30) calendar days, the Charter of the Department may be cancelled;
 - 1. Provided, however, that before the Charter is cancelled the President of the Department in question shall have been
 - a. Duly notified in writing of the charges against it.
 - b. Upon request shall have a suitable opportunity to appear or submit documentation before the National President or the National Council of Administration to show cause why its Charter should not be cancelled.
- C. The Charter of a Department may be revoked by the National Convention

1. If for three-fourths (3/4) of a year has failed to forward its reports, dues, or money properly payable to National Headquarters,
 - a. May be revoked by the National Convention at its annual session or
 - b. By the National President with the consent of the National Council of Administration.

Sec. 611—Department Arrearages

- A. If a Department is in arrears for financial obligations or otherwise, the Department shall be deprived of all representation at the National Convention.
- B. All rights shall be promptly restored upon proper adjustment of such deficiencies.

End of Article VI.

ARTICLE VII - NATIONAL CONVENTION

Sec. 701—Supreme Body

- A. The supreme authority of the Auxiliary shall be lodged in the National Convention of the Auxiliary.
- B. Under the jurisdiction of the National Convention and National Council of Administration of the Veterans of Foreign Wars of the United States.

Sec. 702—National Headquarters

- A. National Headquarters of the Auxiliary shall be maintained in the same location as the National Headquarters of the Veterans of Foreign Wars of the United States.

Sec. 703—Composition

- A. The National Convention of the Auxiliary shall be composed of:
 1. The National President, Past National Presidents and all other elective and appointive National Officers
 - a. So long as they remain a member in good standing in an Auxiliary.
 - b. Each shall be entitled to a personal vote at the National Convention.
 2. The President of each Department.
 - a. In the absence of the Department President, the Senior Vice-President, or in their absence the Junior Vice-President, may function as a member of the National Convention.
 3. Delegates to be elected by each Auxiliary.

Sec. 704—Convention

- A. The National Convention of the Auxiliary shall be held annually
 1. At the same time and place as the National Convention of the Veterans of Foreign Wars of the United States.

Sec. 705—Quorum

- A. The minimum number of Delegates required to constitute a quorum for the transaction of business shall be an accredited representative from a majority of all Departments.

Sec. 706—National Standing Rules

- A. National may establish Standing Rules to provide for certain expenses and disbursements allowable between meetings provided such rules do not conflict with the National Bylaws.
- B. Custom has the status of a Standing Rule; and Standing Rules may be amended, modified, or rescinded at any Council of Administration meeting.
- C. See Section 211.

Sec. 707—Disbursements

- A. All disbursements shall be governed by the National budget as approved by the National Council of Administration.

Sec. 708—National Dues

- A. National dues shall be ten dollars (\$10.00) per annum on each member, effective July 1, 2024, paid by ACH transaction to National Headquarters.

Sec. 709—Membership Dues Cards

- A. National Headquarters shall prepare a standard annual official membership dues card.
- B. Only the Life Membership and Annual Dues Cards provided by National Headquarters shall be officially recognized.

Sec. 710—National Council of Administration, Composition and Duties

- A. There shall be a National Council of Administration which shall consist of the National President, National Senior Vice–President, National Junior Vice–President, National Secretary, National Treasurer, National Chaplain, National Conductor; National Guard, National Chief of Staff (if appointed by the President), National Regional District Council Members as set out in these Bylaws, in Sec. 804E, and the four (4) Junior Past National Presidents not to exceed four (4) calendar years. A majority of the members shall constitute a quorum.
- B. The National Council of Administration shall

1. Be the elected persons to represent their territories and should be prepared to vote at called Council Meetings on whatever might come before the Council.
 2. Meet at such place as may be determined by the National Convention and at such other times and places as the National President may order. This may include electronic meetings.
 3. Make decisions for the body and represent in all matters, in the interval between its National Convention sessions.
 4. Propose and approve expenditures outside National Standing Rules, Budget, and Bylaws.
 5. Decision making/voting may be done using current technology.
 6. Have full power to fix the salaries of the Officers of the organization.
 7. Approve the National budget.
 8. Approve the audit of the Auditing Committee.
- C. The National President shall call a special meeting upon request of a majority of the members of the National Council of Administration.
- D. In the event the National President does not respond to the request or refuses to hold a special meeting
1. The National Council of Administration may, after ten (10) calendar days from the date of mailing of said request, proceed to hold such meeting.
 2. The request shall be in writing to the National President with notification of proof of delivery,
 3. A copy shall be sent to the National Secretary.
 4. Due notice stating the purpose of a special meeting shall be sent to all members of the National Council of Administration by the National Secretary
 - a. Not later than ten (10) calendar days prior to the date of said meeting.
- E. A request for a ruling submitted by a Department
1. Shall be directed to the National President for decision
 2. Sent to the National Secretary
 3. The National President shall respond with their decision within thirty (30) calendar days from the date of receipt.
 4. An appeal from the National President's decision may be taken, within thirty (30) calendar days, to

the National Council of Administration through the Department President.

Sec. 711—National Committees/Meetings & Convention

A. The National President shall appoint all Committees to include Credentials, Resolutions and Rules.

Sec. 711A—National Credentials Committee

A. The Credentials Committee shall examine the credentials and report to the National Convention the number of duly accredited Officers and Delegates present and entitled to vote.

Sec. 711B—National Rules Committee

A. The Rules Committee shall recommend the rules for the guidance and orderly government of the Convention. A copy shall be furnished each Delegate. Adoption of the rules shall be the Convention's first business in order.

Sec. 711C—National Bylaws & Resolutions Committee

A. The National President shall appoint a Bylaws and Resolutions Committee to consist of a Chairman and a minimum to two (2) members. The Committee shall receive all resolutions and present them, with its recommendations, to the National Convention for action.

1. It shall be the duty of the Bylaws and Resolutions Committee to review the National Bylaws every three (3) years, beginning with the year 2011, for accuracy, consistency and compliance with the Bylaws of the Veterans of Foreign Wars (VFW) of the United States and make recommendations to the National President for review and referral to the National Convention.

Sec. 711D—National Program Committees

A. The National President may, in their discretion, appoint Ambassadors and National Chairmen to serve on program committees.

Sec. 711E—National Audit Committee

A. The National President shall appoint an Audit Committee

1. To consist of a Chairman and a minimum of two (2) members from the Council of Administration or any Past National President.

2. It shall be the duty of the Audit Committee to properly review the report of the independent auditors and to submit a report to the National Council of Administration of any material weaknesses or findings of said independent auditors.

Sec. 711F—National Budget Committee

- A. The National President shall appoint a Budget Committee
 1. To consist of a Chairman and a minimum of two (2) members.
 2. It shall be the duty of the Budget Committee to prepare a proposed budget from the tentative budget submitted by the National Treasurer.
 3. Insuring it sets forth all estimated receipts and anticipated expenses for the financial operation of the National Organization for the ensuing year.
 4. The proposed budget shall be submitted in writing by the Chairman of the Budget Committee to the members of the National Council of Administration for adoption at a stated Council of Administration meeting following the National Convention.
 - a. Final action must be taken on the adoption of the budget at said meeting.
 - b. When adopted, it shall control expenditures of the National Organization for the ensuing year.
 - í. Unless otherwise provided by the National Council of Administration.
 5. Once budget is approved by the Council of Administration, it cannot be changed.

Sec. 711G—National Appeals and Grievances Committee

- A. The National President shall appoint an Appeals and Grievances Committee
 1. To consist of a Chairman and a minimum of two (2) members and two (2) alternates
 2. Whose duty it shall be to review such matters as may be submitted to it by direction of the National Bylaws.
 3. The Committee shall report to the National Council of Administration whose action shall constitute final disposition of the appeal.

Sec. 711H—National Life Membership Committee

- A. The Life Membership Committee shall consist of:
 - 1. The National President
 - 2. National Senior Vice–President and
 - 3. National Secretary–Treasurer
- B. Such committee shall be known as the Board of Trustees of the Life Membership Fund.
- C. The Secretary–Treasurer shall be Treasurer of such Board of Trustees and shall have custody of the Life Membership Fund.
- D. The Life Membership Committee shall recommend any fee schedule change.
 - 1. The recommendation shall be brought before the National Convention to be voted upon by the delegates present.
 - 2. Any change in said Life Membership Fee shall take effect the next January 1 immediately following the National Convention at which such fee change was approved.
- C. The Life Membership Committee shall administer the Life Membership Fund.
 - 1. An amount as stated by the Life Membership Committee shall be paid annually to the following entities which each Life Member belongs:
 - a. The National Headquarters of the Auxiliary
 - b. The Department
 - c. The local Auxiliary
 - d. An amount as stated by the Life Membership Committee shall also be paid for any National or Department Life Members At Large to which each Life Member belongs.

Sec. 712—Disposition of Property

- A. In the event of the surrender, cancellation or forfeiture of the Charter of the National Organization of the Auxiliary, its records, money and all other property shall automatically become the property of the Veterans of Foreign Wars of the United States.

End of Article VII.

ARTICLE VIII OFFICERS

Sec. 801—Eligibility

- A. Any member in good standing belonging to an Auxiliary shall be eligible to any office in the Auxiliary, District, Department or the National Organization.
 1. No member shall hold two (2) elective offices on the same level at the same time.
 2. The member may hold one (1) elective and one (1) or more appointive offices on that level.
 - a. The exception to this rule being that a Trustee may hold another elective or appointive office other than President, Secretary, or Treasurer.
 3. Officers, elective or appointive, may hold office in a higher or lower body and such offices may be held concurrently. (i.e., a District President could be elected as a Department Officer. This is not holding two (2) elective offices on the same level.)
 4. Any member who has been removed from office in accordance with Section 809B shall not be eligible for election to that office during the current Auxiliary year.

Sec. 802—Elective Officers

- A. Elective Officers shall include a President, Senior Vice-President, Junior Vice-President, Treasurer, Chaplain, Conductor and Guard.
 1. In addition, Auxiliaries and Districts shall have three (3) elected Trustees.
 2. When an Auxiliary is first instituted, Trustees shall be elected for the balance of that term.
 - a. At the next regular election of Officers one (1) Trustee shall be elected to serve one (1) year, one (1) Trustee to serve two (2) years and one (1) Trustee to serve three (3) years.
 - b. Thereafter, a Trustee shall be elected for a term of three (3) years at the time of election of Officers.
 3. In the event the Department does not have District Presidents, Department elective Officers shall include Auxiliary Presidents.
 4. All elective Officers will be installed as members of the Council of Administration.

5. National elective Officers shall include the National Regional District Council Members elected by the Departments.

Sec. 803—Appointive Officers

- A. The appointive Officers may include a Secretary, Patriotic Instructor, Historian, four (4) Color Bearers, Banner Bearer, Flag Bearer, POW/MIA Flag Bearer, Musician, Soloist, Assistant Conductor, Assistant Guard, Assistant Musician and may include an Assistant Secretary and Assistant Soloist.
 1. Department and National appointive Officers may include a Chief of Staff.
 2. The Department President may appoint an Assistant Treasurer.

Sec. 804—Election

Sec. 804A—All Levels

- A. Any member in good standing (with the exception of At Large Members) may nominate themselves or someone else.
- B. Any member in good standing (with the exception of At Large Members) may run for any office.
- C. Nominating committees shall be permitted.
 1. No member shall be elected to office unless the member is in attendance at the election.
 - a. Unless they submit in writing their willingness to be elected and hold office.

Sec. 804B—Auxiliary

- A. Elective Officers shall be nominated and elected at a regular business meeting in April.
- B. Each year at the regular annual election, one (1) Trustee shall be elected for a three-year (3-year) period.

Sec. 804C—District

- A. The elective Officers shall be nominated and elected annually at the District Convention.
- B. Each year at the annual Convention, one (1) Trustee shall be elected for a three-year (3-year) period.

Sec. 804D—Department

- A. The elective Officers shall be nominated and elected at the annual Department Convention.

- B. Each National Regional District shall be represented by a National Council Member who is a member in good standing in an Auxiliary in the Department currently entitled to representation on the National Council of Administration.
1. The Department Convention preceding the National Convention at which the term is to commence shall, in the same manner and at the same time as Department Officers are elected, elect a National Council Member who shall be installed into office at the National Convention.
 2. Council Members representing even-numbered Regional Districts shall be elected in even-numbered years and those representing odd-numbered Regional Districts shall be elected in odd-numbered years, each for a two-year (2-year) term.
 3. The Regional Districts designated B, D, F and H shall elect a National Council Member in even-numbered years and Districts A, C, E and G shall elect a National Council Member in odd-numbered years, each for a two-year (2-year) term.
(See Booklet of Instructions for further information.)

Sec. 804E—National

- A. Elective Officers shall be nominated and elected at the annual National Convention.
- B. National Regional District Council Members shall be elected from Departments in turn as Departments are listed in this Section thereby giving every Department its turn following expiration of term of office of Council Member from Departments as listed:
1. Maine, New Hampshire
 2. Massachusetts, Vermont
 3. Maryland, New Jersey
 4. Delaware, New York
 5. Illinois, Missouri
 6. Virginia, West Virginia
 7. Kentucky, Tennessee
 8. Alabama, Georgia
 9. North Carolina, South Carolina
 10. Arkansas, Oklahoma
 11. Iowa, Wisconsin
 12. North Dakota, Wyoming
 13. Colorado, Kansas

14. Idaho, Montana
15. Arizona, New Mexico
16. Alaska, Hawaii
17. Nevada, Utah
18. Connecticut, Rhode Island
19. Louisiana, Mississippi
20. Oregon, Washington
21. Nebraska, South Dakota
- A. Pennsylvania
- B. Michigan
- C. Indiana
- D. Ohio
- E. Minnesota
- F. Florida
- G. California
- H. Texas

(See Booklet of Instructions for further information.)

Sec. 805—Voting

- A. For voting procedures, see Booklet of Instructions - Election of Officers or the Ritual.
- B. All Levels
 1. At least one (1) delegate must have registered their credentials at the Convention for the Auxiliary to be entitled to vote the total number of its delegates, which is known as voting strength.
 2. Whether voting by Auxiliaries, Districts or Departments, the President may cast the voting strength.
 3. In the President's absence, the Senior Vice-President, or in their absence, the Junior Vice-President, shall be vested and directed to cast the entire voting strength subject to the will of the delegation present at the Convention.
 - a. If all are absent, the vote shall be taken by roll call of Auxiliaries within the Department.
 - í. The President's vote is lost.
 4. The Auxiliary President, or the Senior Vice-President or Junior Vice-President functioning in their place as a member of the Convention, may at their own option, if elected a Delegate, choose to vote as a Delegate rather than as Auxiliary President.
 5. In voting for Officers, a majority of all votes cast shall be necessary to elect.

6. If there is no election on the first ballot, the member receiving the lowest number of votes shall be dropped and so on in successive ballots until an election is made.
 - a. Officers are entitled to one (1) vote and shall cast their own vote
 - b. An individual with more than one (1) vote has the option of registering their credentials as an Officer or Delegate and casting their vote as registered.
7. Should there be a division among the Delegates, each Delegate present shall be entitled to vote their pro-rata share of the total delegate strength to which the Auxiliary is entitled.
8. Delegates may arrive at a vote in any manner acceptable to them, but the vote shall be announced in whole numbers and not fractional parts of a vote.
 - a. All Delegates are not required to be in the room at the time of the election. At least one (1) Delegate must have been present at the Convention and registered their credentials.
9. Auxiliary Officers
 - a. Shall be elected by written ballot, if more than one (1) candidate, unless the Auxiliary votes prior to the election to allow a roll call vote.
 - b. When voting by written ballot, members attending virtually will text or private message their vote to the Judge and Tellers. Once outcome is announced and there is no objection, all texted and written votes will be deleted/destroyed.
10. District Officers
 - a. May be elected by written ballot or roll call vote.
11. Department Officers
 - a. Shall be elected by roll call vote or by using current technology
 - b. Voting may be by Districts or Auxiliaries
12. National Officers
 - a. Shall be elected by roll call vote or by using current technology
 - b. The voting shall be by Department

Sec. 806—Installation

Sec. 806A—Auxiliary Installation

- A. Auxiliary Officers shall be installed in their respective offices not more than sixty (60) calendar

days prior to the convening of the Department Convention.

1. But shall not assume their duties until the Department President is installed, with the exception of the Auxiliary Secretary and Treasurer. The Auxiliary Secretary and Treasurer shall enter their duties of their respected offices at the conclusion at of the current fiscal year.
2. The installation may be conducted publicly at an open meeting held for that purpose.
3. The following members in good standing may conduct the installation ceremony:
 - a. A member who is a Past or current Auxiliary President
 - b. A member who has held a higher elective office in the Auxiliary
 - c. Or a Past or current Post Commander or higher office.
4. The Auxiliary President-elect will select the Installing Officer.
5. If the following conditions are not met, the installation shall be null and void until such time as the Bylaws are complied with.
 - a. If the offices of President and Treasurer are not bonded
 - b. Quarterly audits are not completed.
 - c. Or an installing officer not authorized according to these Bylaws is chosen
6. The Installing Officer shall ask the retiring President if the office of the Auxiliary President and Treasurer are bonded.
7. Immediately after installation, the Installing Officer shall sign the reports and the Auxiliary Secretary shall see that the reports are transmitted to the National Secretary and the Department Secretary.
8. An Officer-elect who may be absent for good and sufficient reason may be installed at any succeeding meeting within sixty (60) calendar days of the date of installation.
 - a. It shall be the first order of business following the opening ceremony.
 - b. If not then installed, the office shall automatically become vacant.

9. All Officers shall be elected or appointed for one (1) year except Trustees. Only the newly elected Trustees need be installed.

Sec. 806B—District Installation

- A. The District Officers shall be installed before the adjournment of the meeting at which elected.
 1. But shall not assume the duties of office until the installation of the District President as a member of the Department Council of Administration, with the exception of the District Secretary and Treasurer. The District Secretary and Treasurer shall enter their duties of their respected offices at the conclusion at of the current fiscal year.
- B. The following members in good standing may conduct the installation ceremony:
 1. Who is at least a Past or current District President
 2. Who has held a higher elective office in the Auxiliary.
 3. A Past or current District Commander or higher office.
- C. The District President-elect will select the Installing Officer.

Sec. 806C—Department Installation

- A. The Department Officers shall be installed before the adjournment of the Convention at which they were elected.
 1. Unless otherwise authorized by the National President.
- B. They shall enter upon the duties of their respective offices immediately after adjournment of the meeting at which they were installed, with the exception of the Department Secretary and Treasurer. The Department Secretary and Treasurer shall enter their duties of their respected offices at the conclusion at of the current fiscal year.
- C. The Junior Past Department President shall be installed as a member of the Council of Administration.
 1. Pursuant to Sec. 608, the Auxiliary President, in a Department without Districts, will be installed at the Department Convention as a member of the Department Council of Administration.
- D. The President-elect shall select the Installing Officer.
 1. Who shall be a member in good standing
 2. Who is at least a Past or current Department President.

3. Has held higher elective office in the Auxiliary.
 4. Or a Past or current Department Commander or held higher office.
- E. Shall also select the Installing Conductor.
- F. The Installing Officer shall sign and date the installation report. The Department Secretary shall enter the information required into MALTA within seven (7) calendar days following the Department Convention.

Sec. 806D—National Installation

- A. National Officers shall be installed by the Commander-in-Chief or a Past Commander-in-Chief of the Veterans of Foreign Wars of the United States, VFW Auxiliary National President or a Past National President.
- B. Immediately after their election.
1. They shall enter upon the duties of their respective offices immediately after the adjournment of the meeting at which they were installed.
- C. The Junior Past National President shall be installed as a member of the Council of Administration.

Sec. 807—Term of Office

- A. An Officer elected or appointed and installed into office shall continue to hold office for the period for which elected or appointed.
1. Or at the pleasure of the appointive power
 2. Provided they comply with the duties of their office
 3. Remains a member in good standing with dues paid in the Auxiliary, District, or Department of which they are an Officer.
 4. Has not had their office declared vacant in accordance with these Bylaws.
 5. A member elected to fill a vacancy shall continue to hold office for the duration of the un-expired term of the office to which elected.
 6. The term of office of a chairman of a standing committee shall run concurrently with the term of office of the appointing President.
 - a. If the President is unable to complete their term of office. Their appointments will remain in place until the next term of office begins.

Sec. 808—Past Officers

- A. A Past Officer shall be someone who, having been elected or appointed and installed,
1. Ceases to hold office by completion of their term.
 2. Or by death before the expiration of their term of office.

Sec. 809—Resignations

- A. All resignations of Officers should be in writing and sent to the President and Secretary of the body from which the Officer is resigning.
1. If the Secretary is resigning, the resignation shall be sent to the President of the body from which they are resigning.
 2. Resignations are effective when issued.
 3. Verbal resignations are binding.

Sec. 809A—All Levels (Presidents & Vice-Presidents)

- A. In the event of a vacancy in the office of the President or Senior Vice-President
1. The Senior Vice-President succeeds immediately to the title and duties of the President.
 2. The Junior Vice-President succeeds immediately to the title and duties of the Senior Vice-President.
 3. They shall immediately assume their duties without requiring an installation.
 4. An election shall be held at the next regular meeting for the office of Junior Vice-President and any other office vacated.
 5. Due notice of contemplated election shall be deemed given if the President announces that the election will be at the next regular meeting.
 6. The vacant office shall be filled at the stated regular meeting.
 - a. For the purpose of this Section, in the event of a vacancy in the office of President-elect or Senior Vice-President-elect, the same rule shall apply and an election will be held for the office of Junior Vice-President.
 7. If the President or Senior Vice-President chooses not to fulfill the duties of the office, they would need to resign at the next meeting. They are again eligible to run for their former office.
 8. In filling any vacancy, members aspiring to same are privileged to do so;

- a. Officers must resign from their present office when accepting a favorable election.

9. Installation shall be held following the election.

Sec. 809B—Auxiliaries

- A. Auxiliaries may fill other vacancies in their elective offices at any regular meeting provided the President announces that the election will be held at the next regular meeting.
 1. The vacant office shall be filled at the stated regular meeting.
- B. Removal of an Elected Officer
 1. An Auxiliary may, at a regular meeting by majority vote of the members present, declare vacant the position of any elective Officer.
 - a. Who may be absent, without valid excuse from two (2) consecutive meetings, or for a period of sixty (60) days, whichever comes first.
 - b. Or who fails to fulfill the duties of their office as outlined in Article VIII.
 2. An Auxiliary may, at a regular meeting by two-thirds (2/3) vote of the members present remove an elective Officer.
 - a. At least seven (7) days notice shall be given to all members of the intent to remove any elective Officer and state the reason(s) for removal.
 - b. The Auxiliary shall notify the Department President of action taken with document proof (meeting minutes).
- C. The Department President with concurrence of the Department Junior Vice-President or Department Treasurer may, with respect to an Auxiliary within the Department, declare vacant the position of any Auxiliary Officer who fails to fulfill the duties of their office or who physically or verbally abuses another Auxiliary and/or VFW member.
 1. When so removed by the Department President, the Officer shall have the privilege of submitting an appeal to the Department Council of Administration within thirty (30) calendar days from the date of the order declaring such office vacant.
 2. If removal is upheld by the Council of Administration, the Officer shall have the privilege of submitting an

appeal to the National President within thirty (30) calendar days from the date of the Council of Administration decision.

Sec. 809C—District

- A. All other vacancies in elective offices may be filled by election by the District at any regular meeting provided due notice of such contemplated election has been given in writing to all Auxiliaries in the District not less than four (4) weeks prior to such meeting.
- B. The District may at any regular meeting by two-thirds (2/3) vote of the Delegates present, declare vacant the position of any Officer who has absented himself, without valid excuse, from two (2) consecutive meetings.
- C. The Department President with concurrence of the Department Junior Vice-President or the Department Treasurer may, with respect to a District within the Department, declare vacant the position of any District Officer who fails to fulfill the duties of their office as outlined in Article VIII or who physically or verbally abuses another Auxiliary and/or VFW member.
 - 1. When so removed by the Department President, the Officer shall have the privilege of submitting an appeal to the Department Council of Administration within thirty (30) calendar days from the date of the order declaring such office vacant.
 - 2. If removal is upheld by the Council of Administration, the Officer shall have the privilege of submitting an appeal to the National President within thirty (30) calendar days from the date of the Council of Administration decision.

Sec. 809D—Department

- A. In the event of a vacancy in the office of Junior Vice-President or other elective offices
 - 1. The Department President shall duly notify all Auxiliaries in the Department by Official Correspondence that the vacancy exists no less than thirty (30) calendar days before the next scheduled meeting.
 - 2. Nomination and election of a candidate to fill a vacancy shall be made by the Department Council of Administration.

- B. The Department President with concurrence of the Department Junior Vice-President or the Department Treasurer may declare vacant the position of any elected Officer.
1. For failure to fulfill the duties of their office as outlined in Article VII.
 2. Or who physically or verbally abuses another Auxiliary and/or VFW member.
 3. Who without valid excuse, misses two (2) consecutive meetings.
- C. When so removed by the Department President, the Officer shall have the privilege of submitting an appeal to the Department Council of Administration within thirty (30) calendar days from date of order declaring such office vacant.
- D. If removal is upheld by the Council of Administration, the Officer shall have the privilege of submitting an appeal to the National President within thirty (30) calendar days from the date of the Council of Administration decision.

Sec. 809E—National

- A. In the event of a vacancy in the office of Junior Vice-President or other elective offices
1. Except National Regional District Council Member
 2. The National President shall duly notify all members of the Council of Administration and all Departments that the vacancy exists in order that recommendations may be submitted for filling the vacancy.
 3. Thirty (30) calendar days thereafter, members of the Council of Administration shall be advised of the names of the members presented to fill the vacancy and may vote to fill such vacancy in a sealed envelope marked “Ballot,” enclosed in an envelope and forwarded directly to the National Secretary.
 4. The ballots shall be opened at the time specified by the National President
 5. By tellers appointed by them
 6. In the presence of such Officers of the National Convention as the National President may designate.
 7. The member receiving the highest number of votes shall be declared duly elected to the office designated.

- B. In the event of a vacancy in the office of National District Council Member
 - 1. The Department Council of Administration from which the Council Member was elected shall elect a Council Member from recommendations made by Auxiliaries in the Department involved.
- C. The National President or the National Council of Administration may declare vacant the position of any Officer who:
 - 1. Without valid excuse, misses two (2) consecutive meetings of the constituent body of which they are an Officer.
 - 2. For failure to fulfill the duties of their office as outlined in Article VIII.
 - 3. Who physically or verbally abuses another Auxiliary and/or VFW member.
- D. When so removed by the National President, the Officer shall have the privilege of submitting an appeal to the National Council of Administration to be taken within thirty (30) calendar days from date of order declaring such office vacant.

Sec. 810—President, Duties of (All Levels)

- A. The President shall preside and maintain order at all meetings and enforce a strict observance of the Bylaws and Ritual of the Organization and all orders from proper authority.
- B. Shall appoint all Officers and committees not otherwise provided for.
- C. Shall see that there is no disruption during the meeting and if so, has the right to have the member causing the disruption removed.
- D. The President of the Auxiliary to a Department, District or Post shall, within thirty (30) days after installation into office, submit to the Commander of the respective Department, District or Post the last quarterly audit, membership status report, and such additional reports as may be required by the liaison committee. (National President see Section 810E).
 - 1. Such reports will be acknowledged by each respective Commander during the next regular meeting of the Post over which they preside and may be read to the members assembled.
- E. Each Auxiliary President should register for the National Convention if attending.

Sec. 810A—Auxiliary President

- A. The Auxiliary President shall countersign all checks

- drawn by the Treasurer.
- B. Auxiliaries may not possess credit cards.
 - 1. An Auxiliary may vote to accept payment by credit and/or debit card.
 - C. Auxiliaries may possess a debit card for Auxiliary business purposes only. Debit card possession shall be authorized by a majority of the membership present at the meeting and voting.
 - D. Treasurers shall be in possession of the debit card. Debit Cards cannot be used for cash advances.
 - E. Bank statements will be initialed and dated monthly by the Trustees to ensure that all are aware of debit card purchases in a timely manner.
 - F. The disbursement of money shall be upon motion made and passed at a meeting
 - 1. With the exception of:
 - a. The transmittal of membership dues, which does not require a motion.
 - b. Expenses allowed by Standing Rules
 - G. Shall appoint a committee of not less than five (5) members, including the Treasurer, to contact all members during the year for payment of dues.
 - 1. It is recommended that they also contact those who have not paid dues for the preceding years.
 - 2. This Committee shall report on all contacts made and turn any money collected over to the Treasurer as soon as possible,
 - a. No later than the first meeting following collection.
 - b. Volunteers may also be used.
 - H. Shall see that all reports are correctly made out and promptly forwarded.
 - I. All the business of the Auxiliary is transacted in a proper and efficient manner.
 - J. Assure that the President or their representative attend all properly called District Conventions or meetings.

Sec. 810B—District President

- A. The District President shall countersign all checks drawn by the Treasurer for disbursement of money by motion and passed.
- B. Shall conduct an official visit of each Auxiliary in their District annually.
 - 1. See Sections 609 and 906—Official Visit.
- C. Shall hold at least one (1) District meeting each year to promote schools of instruction for Auxiliary Officers

1. In addition to the District Convention
- D. Act as liaison between Auxiliaries in the District and the Department
- E. Do whatever may be in the best interests of the Auxiliary
- F. The District President may conduct an annual Memorial Service in accordance with the Ritual to pay tribute to deceased members.

Sec. 810C—Department President

- A. The Department President may issue general orders or special orders as necessary.
- B. Shall see that all dues and other money due to National Headquarters and received by the Department are forwarded promptly together with the proper reports and returns pertaining thereto.
- C. Shall approve all vouchers for disbursement of Department funds.
- D. Shall see that the office of the Department Treasurer is bonded with an indemnity company authorized by National Headquarters or the Department with sufficient security in a sum to be approved by the Council of Administration.
 1. The cost of which shall be paid from the Department Treasury.
 2. The bond amount must be voted on separately from the budget and included in the minutes.
- E. The Department President shall hold the bond.
- F. The Department President should visit a meeting in each District of the Department at least once during the year.
 1. If they are unable to do so, a Representative shall be sent.
- G. In the event a Department has no Districts, the President shall conduct the official visit of each Auxiliary at least once a year.
- H. The Department President, or the assigned Representative, shall conduct an annual official visit of all Auxiliaries not in a District.
- I. The Department President may include the “Draping of the Charter” and “Memorial Service” in the agenda of the annual Auxiliary Department Convention, jointly in conjunction with the VFW or both, if desired.
- J. The President’s mileage to and from the Department Convention and Council Meetings, together with hotel expenses, shall be paid from the Department Treasury.
- K. When requesting suspension, lifting suspension or

cancellation of an Auxiliary Charter, reasons must be given in writing to the National President.

1. A copy of said request to cancel an Auxiliary shall be sent on the same date to the District Presidents and to the Post, District and Department Commanders no less than thirty (30) calendar days prior to the cancellation of the Charter.

Sec. 810D—National President

- A. The National President shall enforce the orders of the National Convention and Council of Administration
 1. For this purpose the President may issue orders as may be necessary.
- B. The National President shall within thirty (30) days after induction into office, submit to the Commander-in-Chief of the VFW, the accepted audit, the approved budget, June 30 membership status report, a copy of adopted resolutions, approved Bylaw revisions, and such additional reports as may be required by the liaison committee.
- C. Shall decide all questions of laws and usages.
- D. May require an official visit to any Auxiliary whenever they may believe that the best interests of the organization require it.
 1. May delegate any Department Officer and shall prescribe the duties for this purpose.
 2. Has the right to reprimand a member with cause
 - a. Subject to final appeal to the National Convention and from that body to the Council of Administration of the Veterans of Foreign Wars of the United States.
- E. Shall see that the office of the Treasurer and all accountable employees are properly bonded.
- F. Shall sign all Charters of Departments, Districts and Auxiliaries.
- G. Shall order the books of the Secretary and Treasurer to be audited annually by a certified accountant at the expense of the National Treasury.
- H. It is customary for the National President to visit each Department at least once during their term of office.
- I. The President's cost of transportation to and from the National Convention, Council of Administration meetings, and Department visits, together with hotel expenses, shall be paid from the National Treasury, in accordance with the budget.

1. Additional traveling expenses incurred in visiting Departments and Auxiliaries during their term of office shall be determined by the National Council of Administration, and paid from the National Treasury, in accordance with the budget.

Sec. 811—Vice-Presidents, Duties of

A. Vice-Presidents shall

1. When called upon, assist the President by counsel or otherwise
2. In the absence of the President they shall discharge the duties of their office according to seniority.
 - a. If neither of them are present to take the President's office, the Secretary or any Past President will call the meeting to order and the members shall elect a President pro-tem.
3. When the President is unable to perform their duties
 - a. Or function for a period of time due to illness, extended vacation or other reason.
4. Upon written request and approval by the National President
 - a. The Senior Vice-President may be authorized to countersign checks in the President's absence during such a period.

Sec. 812—Secretary, Duties of (All Levels)

A. The Secretary shall keep in books or files:

1. The current "Podium Edition Bylaws and Ritual"
2. A record of all the minutes of each meeting of the Auxiliary
 - a. The manner in which the minutes of the Auxiliary meetings are read, printed and/or distributed shall be at the discretion of the Auxiliary by vote of the membership. Consideration should be given to the cost of printing when voting.
 - b. It is permissible to secure typed or computer generated minutes in the permanent book or insert in a three ring binder or clip folder.
 - c. Each minute page of the minutes shall be numbered consecutively and provide a space for the Trustees to initial at audit.
 - d. The Treasurer's reports and the audit reports must be incorporated in the minutes.
 - e. Corrections shall be made in the margins.
3. Shall attend to all matters of correspondence under the direction of the President.

4. A General or Special Order file for the current year in which shall be preserved all orders and circulars issued by the National and Department Headquarters.
 - a. In the order in which they are received
5. A letter file in which shall be kept all correspondence of the Auxiliary.
 - a. General correspondence to be retained for one (1) year.
 - b. Policy and rulings are to be maintained in a permanent file.
 - c. All communications from National or Department Officers are official and shall be read at a meeting before being filed for reference.
6. All communications of any nature whatsoever intended for the consideration of the National Body shall be signed by the President and forwarded by the Secretary of the Auxiliary to the Department President.
7. All official communications to National Officers from the Auxiliary must also be forwarded through channels.
8. Shall notify orally or in writing all newly elected members.
9. Shall under the direction of the President, prepare all reports required of them.
10. Shall transfer to their successor, without delay, all papers, books and other property of the Auxiliary in their possession.
11. Shall enter the information required from the installation report in MALTA or submit the installation report to the Department Secretary for entry into MALTA within seven (7) calendar days.
12. To perform such other duties as are usually incident to such office.
13. Shall notify all required offices the names and addresses of elected and appointed Officers.

Sec. 812A—Auxiliary Secretary

- A. The Auxiliary Secretary shall
 1. Input or transmit the names of the Delegates and Alternates to Secretaries required to receive them within thirty (30) calendar days of election.
 2. Immediately following installation, enter the required information into MALTA or submit the installation report to the Department Secretary within seven (7) calendar days.

Sec. 812B—Department Secretary

- A. The Department Secretary shall
 1. Assist Auxiliaries to see that all installation reports have been submitted within the appropriate time frame.
 2. Take a complete record of the minutes or transcripts of all meetings of the Department Convention and Council of Administration.
 - a. Which must be preserved as a permanent record.
 - b. May be taken by the Department Secretary or a recorder.
 3. Distribute copies of minutes or transcripts to each member of the Council of Administration.
 4. Distribute copies of the Department Convention minutes or transcripts to all members of the Convention Composition with the exception of the Delegates.
 5. Keep in proper files all correspondence
 - a. A file in which shall be kept copies of all general and special orders issued.
 6. Prepare all books and forms required for the use of the Department under the direction of the President.
 7. Maintain a roster of
 - a. All Department Officers and committees
 - b. Of all District Presidents, Secretaries and Treasurers
 - c. All Auxiliary Presidents, Secretaries, Treasurers
 - d. As well as meeting times and places.
 8. Prepare annual reports of Officers and Chairmen for distribution to Delegates who register at Convention.
 - a. These reports would not have to be read at Convention.
 9. The Secretary's mileage to and from the Department Convention and Council of Administration meetings shall be paid from the Department Treasury.

Sec. 812C—National Secretary

- A. The National Secretary shall
 1. Keep a permanent record of the proceedings of the National Convention and Council of Administration meetings.
 2. Prepare the minutes or transcripts for proper distribution.
 3. Prepare for publication the Officers and Ambassadors annual reports, under the direction of the President.
 4. Issue the necessary orders under the direction of the President.

5. Keep in proper file all general correspondence for the period of one (1) year.
 6. Keep all Special Orders, policy and rulings shall be maintained in a permanent file.
 7. See that all files are screened and maintained in a current status.
 8. Prepare all books and forms required for the use of the Auxiliary under the direction of the President.
- B. The Secretary's records and office shall be maintained at National Headquarters of the Auxiliary and shall be left intact for their successor.
 - C. The Secretary's cost of transportation to and from the National Convention and Council of Administration meetings, together with hotel expenses, shall be paid from the National Treasury.
 - D. The Secretary shall receive as compensation for services such sum as may be determined by the Council of Administration.

Sec. 813—Treasurer, Duties of (All Levels)

- A. Duties of the Treasurer are most efficiently conducted through electronic means.
- B. The Treasurer is responsible for keeping National Headquarters up to date with bank information, i.e. account number and/or routing number.
- C. The Treasurer shall write and sign checks as voted on.
- D. The Treasurer shall be the Treasurer of all Auxiliary committees handling funds.
 1. Upon approval by the National President or the Department President, the Auxiliary President may appoint an acting Treasurer when the Treasurer is unable to function for a period of time due to illness, death, resignation, or extended vacations.
 - a. The request must be in writing to the National President or the Department President.
 2. All funds shall be accounted for by the Treasurer in the Auxiliary books
 - a. Which shall consist of a ledger, cash book, or a computerized system
 - b. And printed and secured in a permanent record book
 - c. So long as the records contain the same data as required formats prescribed by National Headquarters.
 3. The manner in which the Treasurer's Reports are read, printed and/or distributed shall be at the

discretion of the Auxiliary by vote of the membership.

4. The Trustees or Audit Committee members shall sign the Audit and initial all pages of the Treasurer's records.
5. The Treasurer shall collect all money due and give a receipt for all cash and track all other receipts.
6. The Treasurer shall submit all forms necessary to be in compliance with Federal and State regulations.
7. The Treasurer shall, at the end of their term of office, or sooner if so ordered by proper authority, transfer to their successor without delay, all paper, books, money, and other property of the Auxiliary in their possession.

Sec. 813A—Auxiliary Treasurer

- A. The Auxiliary Treasurer shall hold all funds and securities belonging to the Auxiliary in a FDIC or equivalent Banking Institution in the name of the Auxiliary.
 1. An Auxiliary shall have a General Fund and a Relief Fund
 2. And any other funds needed, such as:
 - a. A National and Department Dues Fund
 - b. A Cancer Insurance Fund
 - c. A Kitchen Fund
 - d. A Bingo Fund
 - e. And so forth
 3. Money in the Funds shall be maintained in one (1) checking account.
 - a. However, if state law requires money in the Bingo, Gaming or similar Fund to be maintained in a separate checking account, then the Auxiliary may have two (2) checking accounts.
 - b. Auxiliary bonds purchased for the offices of the President and Treasurer do not cover gaming accounts.
 4. An Auxiliary may also have savings and investment accounts upon approval of the Auxiliary.
 5. Auxiliaries may not possess credit cards.
 - a. An Auxiliary may vote to accept payment by credit and/or debit card.
 6. Auxiliaries may possess a debit card for Auxiliary business purposes only. Debit card possession shall be authorized by a majority of the membership present at the meeting and voting.

7. Treasurers shall be in possession of the debit card.
8. Debit Cards cannot be used for cash advances.
9. Bank statements will be initialed and dated monthly by the Trustees to ensure that all are aware of debit card purchases in a timely manner.
10. Bills may not be paid electronically,
 - a. With the exception of money transferred to National Headquarters
 - b. Or for the purpose of paying taxes
11. The General Fund contains unrestricted monies, which may be expended for any purpose.
12. The other Funds established contain restricted funds, which may only be expended for the purposes for which they were received.
13. The Treasurer shall collect and process dues in accordance with the procedures established by the National Treasurer.
14. The Treasurer's report shall be presented in any manner determined by vote of the Auxiliary.
 - a. Shall include in detail, all receipts and disbursements of the last meeting.
 - b. And pre-approved customary expenses and all receipts since the last meeting.
15. No motion to accept this report is necessary.
16. The Auxiliary Treasurer shall send the names and fees, if applicable, of the Delegates and Alternates to the Department Treasurer prior to the Department Convention.

Sec. 813B—District Treasurer

- A. The Treasurer shall hold the funds and securities
 1. Expend the same only on proper action at a regular or special meeting thereof.
 2. Perform such other duties as are necessary to their office.
 3. The report of the Treasurer at each meeting shall include all receipts and disbursements of the last regular meeting in detail.
 4. The report shall be given in any manner voted on.
 5. No motion to accept this report is necessary.

**Sec. 813C—Department Treasurer
Funds—Receipt and Custodian of**

- A. The Department Treasurer shall
 1. Receive and properly account for all money due and

payable to the Department and National Headquarters, as the Bylaws provide.

2. Give a written receipt as prescribed by National Headquarters for all money other than checks received.
 3. Be the official accountable Officer of the Department
 4. In their care be placed securities, funds and the accountable property of the Department.
 5. The Department is permitted to place funds in savings or investment accounts upon the approval of the Council of Administration.
- B. It is highly recommended that each Department add a second signatory to its Department bank account(s) for the sole purpose of being able to always access the department account(s) should the Department Treasurer become incapacitated and unable to perform the required duties. This person can be the Current Department President, a Past Department Treasurer, Past Department President or whomever the Department deems to be the best person to have access to the Department account(s) should the need arise. The second person may NOT:
1. Write any checks.
 2. Perform the duties of the Treasurer in any way.
- This second person is strictly a signatory to the Department Bank Account(s) in order for the funds to be accessed if needed and the elected Department Treasurer be unable to do so. Once the appointed and approved Acting Department Treasurer, as requested by the Department President and approved by the National President, is able, the Acting Department Treasurer will be added to the Department Bank Accounts(s) and then be able to write and sign checks and perform the duties as the Acting Department Treasurer until such time as a Department Treasurer is able to resume their duties or, if unable to resume duties, until a new Department Treasurer can be properly elected.

Funds—Disbursement of

- A. The Department Treasurer shall expend Department funds only
 1. As approved by the Council of Administration in the annual budget

2. Or as approved by the Council of Administration in the Department Standing Rules
3. Or upon presentation of a proper expenditure voucher with bills attached
 - a. Which shall be within the budget and have the approval of the Department President
 - i.* To expedite processing of Department voucher, approval of voucher may be via e-mail or signature/initial of the President.
 - ii.* Vouchers shall be numbered in sequence .
 - iii.* Reasons for expenditures shall be itemized in detail.
 - iv.* The recipient of payment shall be designated clearly.
4. The Department Treasurer shall furnish the President with a monthly financial report of income and expenditures.
5. The Treasurer's mileage to and from the Department Convention and Council of Administration meetings shall be paid from the Department Treasury.

Reports and Remittance—Dues

- A. The Department Treasurer shall maintain all membership applications from Auxiliaries within the Department in the application file until the member has been deceased for a period of six (6) years or has reached 120 years of age.
 1. This file may be kept electronically.
- B. Shall review report forms and dues payments and observe that the necessary and correct data is shown.
- C. Shall set up and maintain a dues reserve fund to which shall be credited not less than fifty percent (50%) of Annual dues, Member at Large dues and Life Member payout for the current year received prior to July 1.
 1. Shall not disburse nor shall an obligation be incurred against this fund until after July 1.
 2. At which time all money shall be transferred to the Department General Fund for expenditure in accordance with the approved Department budget.
- D. In every instance, the correct amount of National dues must be credited to the National dues account and any and all discrepancies in the total remittance must be carried in the Department's General Fund.

1. National dues and all of the money belonging to National Headquarters shall, as received by the Department Treasurer, be placed in a separate account in the General Fund and in no instance shall it be expended or used for any other purpose than its proper remittance to the National Treasurer.
2. All money shall be remitted to National promptly. To disburse National funds, vouchers may be approved at a later date.

Security—Book Inspection

- A. The Department Treasurer shall be bonded with sufficient security in a sum to be approved by the Council of Administration
 1. The cost of which shall be paid from the Department Treasury.
- B. Books shall be open to inspection by
 1. Council of Administration
 2. Audit Committee
 3. Certified Public Accountant (CPA) should one be employed by the Department.

Reports—Financial

- A. The Treasurer shall prepare a detailed financial report of all transactions since the last meeting
 1. Which is to be printed and distributed to each Council Member at each Council of Administration meeting.
 - a. No motion is required to accept this report.
- B. The Treasurer's financial statement shall be published in the Department Convention report book.
 1. The report book shall be distributed to the Delegates at the Department Convention.
- C. It shall also be the Department Treasurer's duty to:
 1. Maintain a file of the Audit Reports from each Auxiliary and District within the Department for one (1) year.
 - a. Any concerns regarding audits should be brought to the Department President's attention.
 2. Forward a list of delinquent Auxiliaries and Districts or a notice stating all Audit Reports have been received from each to the Department Convention Credentials Chairman.
 3. **A copy of the notice or list of the delinquent Auxiliaries must also be sent to National**

Headquarters within five (5) calendar days following Department Convention annually by the retiring Treasurer.

- D. Immediately following the close of the fiscal year, they shall submit a copy of the approved year-end audit report to the National Treasurer by October 1, unless permission is granted by the National President for an extension.

Budget—Annual

- A. The Department Treasurer shall prepare a tentative budget for the financial operations for the ensuing year.
1. Which shall set forth all estimated receipts and anticipated expenditures for the use of the Budget Committee in preparing the proposed budget
 2. Restricted funds shall be budgeted separately in every instance and the budget shall be in balance.
- B. A copy of the proposed budget shall be submitted in writing to the Department Council of Administration for adoption at a stated Council of Administration meeting.
1. When adopted it shall control expenditures of the Department unless otherwise provided by the Council of Administration.
- C. A copy of the approved budget must be forwarded to the National Treasurer by October 1
1. Unless permission is granted by the National President for an extension.
- D. The Department Treasurer shall prepare a budget report showing current balance of each account quarterly.
1. Or prior to each Council of Administration meeting.
- E. They shall also prepare the final budget report covering the full fiscal year.
- F. A copy of these budget reports shall be given to each member of the Council of Administration and Budget Committee and presented by the Budget Chairman to the Council.

Sec. 813D—National Treasurer

- A. The National Treasurer shall have charge of the funds; and handle all supplies and property not otherwise provided for, of the Auxiliary.
- B. The National Treasurer shall pay all budgeted expenses and all bills incurred according to the approved voucher system set out by the Auditors.

- C. The National Treasurer shall account for amounts received for Life Membership in a special fund called the "Life Membership Fund" in accordance with Generally Accepted Accounting Principles (GAAP) and shall issue a suitable Life Membership Card.

Budget—Annual

- A. The National Treasurer
1. Shall prepare a tentative budget for the financial operations for the ensuing year.
 - a. The tentative budget shall set forth all anticipated income and estimated expenses.
 - b. Restricted funds shall be budgeted separately in every instance and the budget shall be in balance.
 - c. Said tentative budget shall be presented to the National Budget Committee Chairman and National Senior-Vice President no later than July for their use in preparing the proposed budget.
 2. The Budget Committee shall submit the proposed budget to the National President for consideration no less than ten (10) calendar days prior to the meeting of the National Council of Administration at which the annual budget is adopted.
 3. Final action must be taken on the adoption of the budget at the stated meeting of the National Council of Administration.
 4. When adopted, the budget shall control expenditures for the ensuing year,
 - a. Unless otherwise provided by the National Council of Administration
 5. Once the budget is approved by the Council of Administration it cannot be changed.
 6. Immediately following the adoption of the annual budget by the Council of Administration, the National Treasurer shall submit a copy of the approved budget to the National President and the Commander-in-Chief.
 7. Shall keep a correct account of all money due and receivable from all sources.
 8. Shall receive and deposit all money.
 9. Shall prepare a quarterly report for the National President, the National Council of Administration, and the Commander-in-Chief.

10. Annually, after August 31, payment shall be sent to each Department covering a commission allowed the Department of ten percent (10%) of the Auxiliary's net profits for any supplies purchased from VFW Store.
11. Shall prepare for the National President, before each National Convention, a list showing the Auxiliaries in good standing and the number of Delegates to which each is entitled.
12. Shall see that all files are maintained in a current status.
13. The Treasurer's office and records shall be maintained at National Headquarters of the Auxiliary and shall be left intact for their successor.
14. Shall receive as compensation for their services such sum as may be determined by the Council of Administration.
15. The Treasurer's cost of transportation to and from the National Convention and Council of Administration meetings, together with hotel expenses, shall be paid from the National Treasury.

Sec. 814—Trustees, Duties of (All Levels)

- A. All audits are to be completed by the elected Trustees
 1. With a minimum of two (2) in attendance. At least one (1) must be an elected Trustee.
 2. The President, Secretary and Treasurer should attend the audit. They are not allowed to perform the audit.
 3. A motion to accept the audit, signed and completed by the most Senior Trustee present at the audit is required, prior to forwarding to the Department Treasurer.
 4. A pro tem can be appointed to audit the books under extenuating circumstances.
- B. It shall be the duty of the Trustees
 1. To properly audit the books and records of the Auxiliary Treasurer and Secretary no later than the end of the month following the expiration of each quarterly period.
- C. If an Auxiliary or District is in arrears for any of the following, the Auxiliary or District President shall be deprived of their vote at the Department Convention:
 1. For any financial obligations to National Headquarters.

2. For failure to bond the office of Auxiliary or District President and Treasurer.
3. For failure to submit accepted audits to the Department Treasurer within thirty (30) calendar days of each meeting (or quarterly, if monthly meetings are held).

Quarter	Months Covered	Audit Completed by	Accepted Audit sent to Department Treasurer no later than
First	January, February, March	April 30, Annually	May 31, Annually
Second	April, May, June	July 31, Annually NOTE: <i>Invite outgoing Treasurer and outgoing Trustee to the Audit.</i>	August 31, Annually
Third	July, August, September	October 31, Annually	November 30, Annually
Fourth	October, November, December	January 31, Annually	February 28, Annually

4. Trustees and pro tems shall sign the audit
5. All pages attached to the record books shall be signed/initialed by the Trustees at time of the audit.
(See Booklet of Instructions)
6. The Trustees shall submit and read the written report during an Auxiliary meeting.
7. A copy of the accepted audit shall be included in the minutes record book.
8. Quarterly they shall record the date of audit made and certify by their signatures in all books that the books and records were found correct.
9. They shall verify all expenditures of the Auxiliary and certify by their signatures to the correctness of each bill before payment may be made of same by the Treasurer.
10. They shall, in addition to the foregoing, audit the records and accounts of all committees, Officers and members, having to do with the receipt and

expenditure of the Auxiliary, District funds and perform such other duties incident to their office as the Auxiliary may direct or the law require.

11. The Senior Trustee whose term expires at the next election serves as Chairman and shall call the meetings for the audits.
 12. Audit reports must be incorporated in the minutes, but the Secretary may read only the balances.
- D. Any negligence on the part of the Trustees in carrying out the mandates of this Section, or in attending audits, shall make them individually and collectively responsible, with any others, for any discrepancy.
- E. It shall be the duty of the Trustees to see that the offices of the President and Treasurer are bonded with an indemnity company authorized by National Headquarters or the Department.
1. As surety in a sum at least double the amount of funds and value of property for which, so far as can be anticipated, the President and Treasurer may be accountable.
 2. The amount shall be approved by the body and the bond premium paid from their funds. A motion shall be made, passed and included in the Secretary's minutes.
 3. The office of President shall hold the original bond of both offices.
 4. A copy of both the President and Treasurer bonds shall be incorporated into the minutes each year.
 5. Bonds do not cover gaming accounts i.e., Bingo (See the Treasurer's Guide).
- F. Should a Trustee resign, move away, etc. the Auxiliary will elect a member to fill the un-expired term of that particular Trustee.

Sec. 814A—Department Arrearages

- A. If a Department is in arrears for financial obligations or otherwise, the Department shall be deprived of all representation at the National Convention.
- B. All rights shall be promptly restored upon proper adjustment of such deficiencies.

Sec. 815—Chief of Staff, Duties of

Sec. 815A—Department

- A. The Chief of Staff shall, if so appointed
 1. Have charge of organizing and extension of new

- Auxiliaries in their Department while working alongside the organizer and/or organizing team.
2. Shall perform the duties necessary to their office and assigned by the President.
 3. Shall make reports to the Department President as may be required.
 4. Shall oversee new Auxiliaries to be assured that the authorized organizer works with them in instructing them in the workings of the organization.
 5. Shall also work closely with the Auxiliaries having less than ten (10) members paid by February 1 of the current year.
 6. The **Department President** may appoint Deputy Chief of Staff in each District to work with the Department Chief of Staff.

Sec. 815B—National

- A. The Chief of Staff, under the direction of the President, shall, if so appointed, have charge of all extension work pertaining to the organizing of Auxiliaries and assisting Auxiliaries needing help and perform other duties as requested by the President.

Sec. 816—Chaplain, Duties of

- A. The Chaplain shall perform such duties in connection with their office as the Ritual may prescribe, or the President may require.

Sec. 817—Conductor, Duties of

- A. The Conductor shall assist the President and perform such duties as the Ritual may prescribe.
- B. Shall arrange the room and put away paraphernalia at the close of the meeting.

Sec. 818—Guard, Duties of

- A. The Guard shall take their place at the door of the room in which the meeting is held.
- B. Shall admit only those who are entitled to attend.
- C. Never leaves their position at the door while the meeting is in session, unless relieved by someone appointed by the Presiding Officer to fill their station.

Sec. 819—Patriotic Instructor, Duties of

- A. The Patriotic Instructor shall see that the room is in keeping with the Ritual.

- B. Shall instruct the members in the proper use of and salute to the Flag.
- C. Shall maintain a record of all patriotic days and initiate programs for their proper observance and perform such other duties as the President may require.

Sec. 820—Color Bearers, Flag and Banner Bearers and POW/MIA Flag Bearer, Duties of

- A. The Color Bearers, Flag and Banner Bearers and POW/MIA Flag Bearer shall have charge of the Colors and banner and perform such other duties as the Ritual or President may require.

Sec. 821—Historian, Duties of

- A. The Historian shall collect all authentic material pertaining to the history of their Auxiliary, carefully compile the same, and submit a report at the end of the year.

Sec. 822—Musician—Soloist, Duties of

- A. The Musician shall preside at the piano.
- B. The Soloist shall sing and lead the audience in song.
- C. Both shall perform such duties as the President may direct.

Sec. 823—Assistant Secretary, Conductor, Guard, Musician & Soloist, Duties of

- A. The Assistant Officers (if appointed) shall be ready at all times to assist in any way requested during the meeting and perform such other duties as the President may direct.

End of Article VIII.

ARTICLE IX MISCELLANEOUS PROVISIONS

Sec. 901—Ritual and Bylaws, Distribution of

- A. The Ritual and current edition of the Bylaws of the Auxiliary shall be made available for purchase by all members in good standing.

Sec. 902—Meeting Etiquette

- A. Cell Phones
 1. All cell phones and electronic messaging devices shall be set to the “off,” “mute,” or “vibrate” position during the entire meeting.
 2. Cell phones may be used for meeting-related purposes, i.e., calendar, calculator, MALTA, research, taking notes, etc.
 3. All calls shall be answered outside the meeting room.
 - a. The only exception shall be during the National Convention, where walkie-talkies or similar devices are used by the National President and National Headquarters staff for meeting purposes only.
- B. Audio/Video Recording
 1. Individual members cannot record (video/audio) any portion of any Auxiliary meeting without prior knowledge of the body.
- C. Smoking
 1. To include but not limited to tobacco products, e-cigarettes, etc., is not allowed during an Auxiliary meeting.
- D. Alcoholic Beverages
 1. No alcoholic beverages will be permitted during Auxiliary meetings.

Sec. 903—What May Be Published

- A. Any part of the proceedings of any Auxiliary may be published if ordered by vote of the Auxiliary unless otherwise provided in these Bylaws.
- B. Any part of the proceedings of a Convention of the Auxiliary may be published if ordered by the Convention or the National President.

Sec. 904—Relief Fund

- A. A Relief Fund must be established by each Auxiliary.
 1. Receipts and expenditures must be in accordance with the Booklet of Instructions.

Sec. 905—VFW National Home Funds, Soliciting for

- A. Before soliciting outside the organization for funds to benefit the VFW National Home, Auxiliaries must have the consent and approval of the next higher authority.
 - 1. The Auxiliary shall submit a written proposal including all contracts, literature, and advertising material pertaining to the proposed solicitation.
 - 2. The approving body is hereby given authority to demand any and all information deemed necessary to determine the propriety of the undertaking and the percentage of net profits, which shall accrue to the VFW National Home.
- B. If permission is granted, the approval shall be made a matter of record and a copy of the application, together with data filed, shall be forwarded to the Secretary of the National Home for their files.
- C. In case an application is refused
 - 1. The applying Auxiliary shall have the right of appeal to the Commander-in-Chief and the National Council of Administration after filing copies of the application and data, together with action thereon, with the Adjutant General.
- D. In no case shall any permission for solicitation in the name of the VFW National Home be granted where it is found that less than fifty percent (50%) of the net proceeds accrue to the Home.

Sec. 906—Official Visit

- A. All books, papers, accounts, records and proceedings pertaining to the Auxiliaries shall be subject to review at all times on order of the National or Department President.

Sec. 907—Floor Work

- A. Floor work shall be conducted in accordance with the Ritual of the Auxiliary.

Sec. 908—Children, Caregivers of Members and Members that are Caregivers Attending Meetings

- A. Children are allowed to attend meetings if accompanied by an Auxiliary member.
- B. Caregiver of a member may attend an Auxiliary meeting when accompanied by the Auxiliary member.
- C. Members performing the task of a Caregiver for a non-member may bring that individual to the

Auxiliary meeting when accompanied by the Auxiliary member.

Sec. 909—Donations—National

- A. No donations shall be solicited by National Headquarters of the Auxiliary except by prior action of the National Council of Administration or National Convention.
- B. Nothing in this Section shall be construed as prohibiting the Auxiliary from soliciting its membership in support of the activities duly authorized and organized by the Veterans of Foreign Wars.

Sec. 910—Control of Mailing Lists

- A. The names and addresses of the members of the Auxiliary shall be considered confidential and shall not be made available for commercial or political use.
- B. Nothing in this Section shall be construed as prohibiting the Auxiliary from soliciting its membership in support of the activities duly authorized and organized by the Veterans of Foreign Wars.

Sec. 911—Politics

- A. No Officer or member of the Auxiliary shall in any manner use this organization for political purposes.
- B. No discussion of partisan questions shall be permitted at any member meetings, on any of the organization's Social Media pages or on any electronic presence.
- C. Nor shall any nomination for political office be made.
- D. Nothing in this Section shall be construed as prohibiting the Auxiliary from soliciting its membership in support of the activities duly authorized and organized by the Veterans of Foreign Wars.

Sec. 912—Titles of Address

Sec. 912A—Title of Department Officers

- A. In those Departments, which are located within states of the United States, the Officers and committee members of such Departments shall have their office or title designated as State rather than Department for Publicity and Public Relations purposes only.

Sec. 913—Members

- A. Officers shall be addressed by the titles of their office preceded by the word, “Mister” or “Madam.”

Sec. 914—Supplies and Equipment

- A. Auxiliaries, District, Department or individual

Auxiliary members may order from the VFW Store using the procedures provided by the VFW.

Sec. 915—Solicitation of Funds

- A. Auxiliaries, Districts or Departments shall not solicit funds or donations except by prior vote.
- B. No Auxiliary shall be permitted to solicit funds or donations by employing, in part or in whole, fund-raising organizations or individuals, without the prior approval of the Auxiliary Department Council of Administration, i.e., GoFundMe, Facebook Fundraisers, DonorsChoose.org.
- C. Auxiliaries on all levels may accept unsolicited donations.
- D. Auxiliaries on all levels may ask for sponsorships. You must coordinate with your corresponding VFW to be sure you do not overstep into their possible sponsorship activity.

Sec. 916—Rules of Order

- A. Rules for governing the conduct of meetings for the Auxiliary shall be as prescribed in the Ritual.
- B. *Robert's Rules of Order, Newly Revised* shall govern on all points **not covered** in these Bylaws.

Sec. 917—Incorporation

- A. The Articles of Incorporation of any such corporation include the provisions hereinafter specified in Section 917A:

Sec. 917A—For Departments, Districts and/or Auxiliaries:

- A. The active and voting membership of this corporation shall, at all times, consist of and be confined to the active membership in good standing of Veterans of Foreign Wars of the United States Auxiliary to (actual name and number of the Post/District/Department).
- B. This incorporated organization shall be and at all times remain under the jurisdiction of the National Convention, National President and National Council of Administration of the Auxiliary, the Commander-in-Chief and of the Veterans of Foreign Wars of the United States, and Post No. (number of Post/District or Department), Veterans of Foreign Wars of the United States and subject to the Bylaws and Rules and Regulations of the Auxiliary and the Charter, Bylaws and Manual of Procedure of the Veterans of Foreign Wars of the United States.

- C. In the event of a dissolution of this corporation, all assets shall be the property of Veterans of Foreign Wars of the United States Auxiliary to (actual name and number of the Post/District/Department) or the simultaneous dissolution of this corporation and loss or forfeiture of its Charter, title to all assets shall pass to the VFW Auxiliary Department of _____ or to the National Auxiliary (Department only), to be disposed of according to Bylaws. At no time shall the assets of this corporation be distributed among the individual members thereof.
- D. The Articles shall, in addition, contain a provision specifically excluding from the powers of the corporation the power to own or hold real property.
1. Should any state law prohibit the provisions herein specified, it shall be permissible to change the provision sufficiently to conform to state law so long as the change is not inconsistent with the purpose of preceding provisions. Failure to comply with those provisions will result in suspension or revocation of the Charter.
 2. Proposed Articles of Incorporation and amendments thereto shall be forwarded to the Department President for review through channels to the National Secretary for review by the National President for compliance with this Section.
 - a. Articles shall not be filed with the appropriate state officials until review has been completed.
 - b. No proposed Articles or amendments thereto shall be reviewed by the National President unless so recommended by the Department President.

Sec. 918—Construction

- A. These Bylaws shall be applied liberally to accomplish the objects of the organization.
- B. In the event any provision of these Bylaws is found to conflict with any Federal, State or local law, rule or regulation, that provision shall be null and void without affecting the remaining provisions.

Sec. 919—Fiscal Year

- A. The fiscal year of Auxiliaries, Districts and Departments shall be July 1 through June 30 of each year.

End of Article IX.

ARTICLE X - ORGANIZATIONAL IMAGE

Sec. 1001—Official Look

- A. The official look for all members include one of the following shirts to be worn with either black pants, black skirt or black dress and black shoes*(with the exception of flip flops unless medically necessary. Per the Americans with Disability Act (ADA) you may not ask a member if they are medically necessary):
1. Marine blue shirt with long, short or 3/4 sleeves with the Auxiliary logo on the left chest, must be purchased from the VFW Store.
 - a. The VFW and Auxiliary collar pins shall be worn
 - i.* VFW on the left collar (over the heart)
 - ii.* AUX on the right collar (as shown in the diagram, page 33 in the yellow pages)
 - iii.* Collar pins are to be ordered from the VFW Store.
- B. The official cap of Ladies Modified or Overseas style for either female or male is acceptable and optional. It shall be Marine blue with Gold braid and include on the right side embroidered lettering in gold thread AUX and your Auxiliary/Post number (i.e.: AUX 1234) or VFW AUX and the VFW Auxiliary Cross of Malta emblem; and on the left side, your state name (unless there are space limitations, then state may be on right side). The option of additional standardized embroidered lettering, as approved by the VFW Auxiliary National Headquarters, is acceptable on the left side at an additional charge. A Life Member patch is approved for the right side, as optional and at an additional charge. Caps to be worn with or without the official look marine blue shirt or blouse. Members will purchase their own caps from the VFW Store.
- C. National Convention Attire: The official look of the marine blue blouse or the marine blue shirt for members, black pants, black skirt or black dress and black shoes* are to be worn as the official National Convention organization image. This will be worn by all elected and appointed National Officers, National District Council Members and National Ambassadors during the National Convention business sessions.

Sec. 1002—Past Officers' Pins

- A. All Past Presidents are eligible to receive a Past President's Pin provided they have served from installation to installation.
 - 1. No one other than a Past President is permitted to wear a Past President's Pin.
 - 1. A Past President shall not be entitled to wear the pin unless they are a member in good standing.
- B. Past Officers may wear the pin designating the highest position they have attained in the Auxiliary.
 - 1. The pin for all other Past Presidents shall be the gold pin with the addition of a jewel on top designating the office as follows:
 - a. Past National President: Diamond
 - b. Past Department President: Ruby
 - c. Past District President: Topaz
 - d. Past Auxiliary President: No jewel
 - 2. If a member is a Past President of more than one (1) body, they may wear the jewels on one (1) pin providing the jewel of the highest office is placed at the top.
- C. A Secretary, Treasurer or Chaplain who has served three (3) consecutive terms, may by vote of their Auxiliary, be presented with a Past Officer's Pin.
 - 1. To be eligible to wear one (1) of these pins, a member must have served in one (1) of these offices.
 - 2. The insignia of rank placed upon the Past Officers pins shall be as follows:
 - a. Past President, Gavel
 - b. Past Secretary, Crossed Quills
 - c. Past Treasurer, Crossed Keys
 - d. Past Chaplain, Open Bible

Sec. 1003—Auxiliary Emblem and Logo

- A. The emblem and Logo of the Auxiliary belongs to the Veterans of Foreign Wars National Organization.
- B. The basic motif is the Maltese Cross, which takes us back to the days of the Crusades when it was bestowed as a decoration on Hospitalers and members of other knightly orders. The eagle in the center represents the government of the United States; the crossed guns, the United States Artillery; the crossed anchors, the United States Navy; the crossed rifles, the infantry; the crossed swords, the cavalry.

- C. The new VFW Logo with Auxiliary underneath, referred to as the VFW Auxiliary logo, may be used for flyers, programs, promotional materials and items purchased through the VFW Store. All other uses must be approved by the Quartermaster General's office. However, the Official emblem of the VFW Auxiliary remains the Cross of Malta.
- D. Departments, Districts, Auxiliaries or individual members shall not manufacture or have manufactured or reproduce any article or emblematic jewelry, pins, or badges containing this emblem or logo without prior written consent of the VFW Quartermaster General.
- E. The motto is “IN FORTITUDE AND LOYALTY.”
- F. The tag line is “UNWAVERING SUPPORT FOR UNCOMMON HEROES®.”

Sec. 1004—Seals

- A. Auxiliaries on all levels shall have a seal, which shall be used on all official documents. Please be aware that due to manufacturing limitations, abbreviations may be made.
- B. New Auxiliaries will be given a seal with the name of the Auxiliary, town and state, and date of institution of the Auxiliary thereon.

Sec. 1004A—Auxiliary

- A. For local Auxiliaries the legend shall read “VFW AUXILIARY TO POST NO. (insert Post number)” and the name of the city and state in which it is located and the date of institution of the Auxiliary.

Sec. 1004B—Districts

- A. For Districts the legend shall read “VFW AUXILIARY TO DISTRICT (number of District), DEPARTMENT OF (insert name of Department).”

Sec. 1004C—Departments

- A. The seal shall be identical with that of the National Convention except the legend for Department Seals shall read “VFW AUXILIARY DEPARTMENT OF (insert name of Department)” and the date of the institution of the Department.

Sec. 1004D—National

- A. The Great Seal of the VFW Auxiliary shall be the

same design as the official insignia and encircled with the legend “VETERANS OF FOREIGN WARS OF THE UNITED STATES AUXILIARY-NATIONAL CONVENTION.”

Sec. 1005—Official Name

- A. While the official name of this organization is “Veterans of Foreign Wars of the United States Auxiliary®,” the same may be abbreviated to read “VFW Auxiliary®.”

Sec. 1006—Color of Units

- A. The Colors of the Auxiliary shall show the authorized emblem of the Auxiliary on fields, which shall be colored as follows:
1. National Convention, Purple
 2. Department, Maroon
 3. Districts, Maroon over White
 4. Auxiliaries, National Blue
 - a. Department Colors shall bear the name of the Department and the date of institution.
 - b. Department District Colors shall bear the name of the Department and the numerical designation of the District.
 - c. Auxiliary Colors shall bear the name, number, location of the Auxiliary and the date of institution.
- B. The American Flag shall be displayed whenever any Banner of the Auxiliary or the POW/MIA flag shall be likewise displayed.

End of Article X.

ARTICLE XI—DISCIPLINE

Sec. 1101—Discipline of Members

- A. Except as otherwise provided in these Bylaws and the Booklet of Instructions for Discipline & Disciplinary Actions, no member shall be subject to the penalties prescribed in Section 1107, unless such member shall have been advised in writing of the charges against them and afforded the opportunity to request that such charges be heard and determined at a Disciplinary Hearing as hereinafter provided.
- B. No disciplinary action may be initiated with respect to conduct that has been the subject of previously initiated disciplinary action.

Sec. 1102—Offenses

- A. Members who have committed offenses recognized by the Auxiliary **MAY** be subject to disciplinary action and may be assessed the penalties provided in this Article.
- B. Offenses recognized by the Auxiliary are:
 - 1. Disloyalty to the United States of America.
 - 2. Failure to fulfill the obligations taken at time of application and admission or the obligations taken upon installation of any office.
 - 3. False representation or deliberate concealment concerning eligibility to membership, office, or acquiescing in or permitting ineligible persons to become members or officers.
 - 4. Disobedience or disregard of the provisions of the Bylaws (at all levels), Booklet of Instructions, Ritual, General Orders or any other laws and usages of the Veterans of Foreign Wars of the United States Auxiliary or any order of the National President.
 - 5. Conviction of, or entering a guilty or no contest plea to a felony, or to a misdemeanor, or ordinance violation involving illegal moral acts, in any court in the United States.
 - 6. Conduct prejudicial to good order and discipline or conduct unbecoming a member in their relations to the VFW Auxiliary or the VFW organization or any member(s) thereof.
 - 7. Conduct requiring document law enforcement intervention (police report) or attempts to maintain order (Section 810) have failed.

8. Preparing or signing any false record, return, regulation, order or other official document of or concerning the Auxiliary, knowing it to be false, or making any other false official statement with the intent to deceive.
9. Selling or otherwise disposing of money or property without proper authority or, willfully or negligently damaging, destroying or losing any such money or property belonging to the Auxiliary, or any Auxiliary, District or Department.
10. Aiding, abetting, counseling, concealing, commanding, conspiring, soliciting, procuring or causing to be done any act which, if done, would be punishable under this Article.
11. Knowingly making or causing to be made a false entry in or false alteration of a government record. Knowingly conveying or causing to be conveyed in any form false information concerning one's military record.
12. Knowingly providing false information or statements in connection with the initiation of charges against another member.

Sec. 1103—Disciplinary Actions or Alternative Actions

- A. Disciplinary actions shall be initiated only when there are reasonable grounds to believe that an offense has been committed by the person charged and a signed incident report or appropriate documentation is submitted by the accuser to the appropriate President (i.e., Auxiliary, Department, National President).
- B. Prior to the Auxiliary vote to initiate disciplinary action, the Auxiliary or Department or its respective President or the National President, shall appoint an individual or committee to investigate alleged offenses brought to its attention by a member and report to the body the results of such investigation.
- C. **The investigations committee shall make one of the following suggestions to the Auxiliary.**
 1. Does not go forward.
 2. Letter of Reprimand
 - a. Auxiliary President
 - b. Department President

3. Mediation

a. Mediation Volunteer appointed by Department President (if the Department President may be called to testify, the National President may appoint a team).

4. Discipline Action brought,

a. The Auxiliary or Department President will decide how to proceed.

Who May Initiate

- A. The Auxiliary may, acting by two-thirds (2/3) vote at a regular or special meeting, instruct the Auxiliary President to initiate such action with respect to a member of the Auxiliary.
- B. A Department President may initiate such action with respect to any member within the Department.
- C. The Department Convention or Department Council of Administration may, by two-thirds (2/3) vote, instruct the Department President to initiate such a proceeding.
- D. The National President may initiate such action with respect to any member of the Auxiliary to the Veterans of Foreign Wars of the United States.
- E. The National Council of Administration may, by two-thirds (2/3) vote, instruct the National President to initiate such a proceeding. In the event the National President is the accused, the National Council of Administration shall designate a member to initiate such disciplinary action.
- F. If the respective President fails or refuses to initiate a disciplinary action after being instructed to do so, another member may be instructed to initiate the action.
- G. If the President is the accused, action must be initiated by higher authority.

How to Initiate

- A. Disciplinary Actions must be initiated by the preparation and delivery of written Charges and Specifications to the accused member.

Charges and Specifications—How prepared and Delivered

- A. Charges and Specifications must be prepared and delivered in the manner described and authorized in the Booklet of Instructions on Disciplinary Actions.

Hearing Requested

- A. If the accused member desires a Disciplinary Hearing, such member must request a hearing within thirty (30) calendar days.
 1. Such request shall be made in the manner prescribed in the Booklet of Instructions for Discipline & Disciplinary Actions.

No Hearing Requested

- A. In the event that the accused member does not properly request a Disciplinary Hearing within thirty (30) calendar days or, prior to the expiration of the thirty (30) calendar day period, advise the President or the designated member initiating the action that a hearing is not desired, the President or the designated member initiating the charges, may take such action as is deemed appropriate including the ordering of any penalties prescribed in Section 1007 of these Bylaws.
- B. If initiated at the Auxiliary, the Auxiliary President or the designated member initiating the charges, must have concurrence by two-thirds (2/3) vote of the Auxiliary to order any penalties prescribed in Section 1007 of these Bylaws.
- C. If initiated by the Department President, they may order any penalties prescribed in Section 1007 of these Bylaws.
- D. The Department Council of Administration or the Department Convention causing the Charges to be initiated shall, by two-thirds (2/3) vote, order any penalties prescribed in Section 1007 of these Bylaws.
- E. If initiated by the National President, they may order any penalties prescribed in Section 1007 of these Bylaws.
- F. If the National Council of Administration initiated the charges, they can by two-thirds (2/3) vote, order any penalties prescribed in Section 1007 of these Bylaws.
- G. Any action taken must be in writing and delivered by registered or certified mail, return receipt requested to the last known address of the accused member. Such action shall include notification of appellate rights.
- H. A copy thereof must also be forwarded to the next higher authority.

Sec. 1104—Appeal

- A. Any member against whom disciplinary action is taken

under this Article shall have the right to appeal such action (with the exception of cases settled through mediation).

1. Such appeal shall be made in the manner prescribed in the Booklet of Instructions for Discipline & Disciplinary Actions.
- B. If the member fails to properly appeal the action in the manner specified in the Booklet of Discipline & Disciplinary Actions, the appeal will not be considered.
- C. With respect to appeals from the imposition of penalties where no hearing was properly requested, the member shall be entitled to appeal only the severity of the penalty and shall not be entitled to contest the commission of the offense.

Appeals to the Department President

- A. Appeals from disciplinary actions initiated by the Auxiliary shall be to the Department President.
- B. The decision of the Department President shall be final unless an appeal is filed within thirty (30) calendar days to the National President.
- C. The decision of the National President shall be final unless an appeal is filed within thirty (30) calendar days to the National Council of Administration.
- D. The decision of the National Council of Administration shall be final unless an appeal is filed within thirty (30) calendar days to the National Convention.

Appeals to the National President

- A. Appeals from disciplinary actions initiated by a Department President shall be to the National President.
- B. The decision of the National President shall be final unless an appeal is filed within thirty (30) calendar days to the National Council of Administration.
- C. The decision of the National Council of Administration shall be final unless an appeal is filed within thirty (30) calendar days to the National Convention.

Appeals to the National Council of Administration

- A. Appeals from disciplinary actions initiated by the National President shall be to the National Council of Administration.
- B. The decision of the National Council of Administration shall be final unless an appeal is filed within thirty (30) calendar days to the National Convention.

- C. Except as provided in Section 1005, no penalty in a disciplinary action shall be carried into effect if an appeal has been taken and such appeal has not been finally adjudicated.
- D. The penalty shall be carried into effect at such time as a decision is final and by execution of a Special Order by the National President or the National Council of Administration.
- E. Nothing herein shall be construed as preventing the National President from enforcing the provisions of these Bylaws, Booklet of Instructions for Discipline & Disciplinary Actions, Ritual or laws or usages and/or the duties of her office, regardless of any pending appeal.

Computation of Time

- A. Whenever these Bylaws or Booklet of Instructions for Discipline & Disciplinary Actions requires action, with respect to appeals, within a specific number of days it refers to calendar days.
 - 1. The time shall be calculated beginning with the day upon which the decision at the previous level was delivered to the last known address of the member.
- B. Any required action by the member must be made in writing and mailed by registered or certified mail, return receipt requested, and postmarked no later than the date due.
- C. The National President may grant an extension provided the request is received prior to the expiration of the time frame originally prescribed and that the request is for good and sufficient cause.

Sec. 1105—Suspension from Office

- A. At any time after charges are initiated against a member holding office, the National President or Department President having jurisdiction, may suspend the accused member from office pending a final decision on the disciplinary action.
 - 1. Provided that with respect to salaried officers, said suspension shall be with pay.
- B. During the suspension of an Auxiliary, District or Department President, the office shall be temporarily filled by the Senior Vice President.
- C. Suspensions affected under this Section shall not be subject to appeal.

Sec. 1106—Prima Facie Case

- A. If the accused member has been convicted of a violation subjecting them to discipline under Section 1002, certified copies of the judicial record of conviction or plea shall be conclusive evidence of a violation of said Section and a President or Disciplinary Hearing Panel may consider the matter as if the accused was willfully absent.

Sec. 1107—Penalties

- A. Penalties for offenses recognized by the Veterans of Foreign Wars of the United States Auxiliary shall be:
 - 1. Reprimand.
 - 2. Suspension or removal from office.
 - 3. Suspension of certain rights or privileges of membership for a specified period of time.
 - 4. Suspension from membership for a specified period of time.
 - 5. Termination of membership.
 - 6. By other administrative action deemed appropriate.

Sec. 1108—Administrative Actions

- A. A member who has been suspended from any Auxiliary by sentence of disciplinary action properly carried into execution, shall be placed as Department Member At Large.
- B. Upon completion of the suspension of membership a transfer is permitted in accordance with the provisions of Section 106 of the National Bylaws.
- C. In the event that a member transfers their membership and reasonable grounds exist to initiate disciplinary action, the Department President or the National President may transfer the member back to the jurisdiction where the disciplinary action will be initiated.
- D. Any member, or former member, sentenced will be allowed one (1) opportunity to petition directly to the National President to have their conviction pardoned or their sentence commuted provided at least five (5) years of the pertinent sentence have been served.

End of Article XI.

ARTICLE XII—AMENDMENTS

Sec. 1201—Amendments—Bylaws

- A. These Bylaws may only be amended or altered at the National Convention by a two-thirds (2/3) vote of the duly accredited Officers and Delegates registered as of the close of the credentials registration on the day before the vote is taken.
- B. These Bylaws shall automatically be amended by any action taken by any National Convention of the Veterans of Foreign Wars of the United States, governing changes in their Bylaws affecting the Bylaws of the Auxiliary.
- C. All amendments adopted at any National Convention according to the provisions of this Section shall take effect thirty (30) days following the close of the said Convention, unless found to be in conflict with VFW National Bylaws.
- D. Per Section 711C it shall be the duty of the Bylaws and Resolutions Committee to review the National Bylaws every three (3) years, beginning with the year 2011, for accuracy, consistency and compliance with the Bylaws of the Veterans of Foreign Wars (VFW) of the United States and make recommendations to the National President for review and referral to the National Convention.

Sec. 1202—Amendments—Ritual

- A. The Ritual of the Veterans of Foreign Wars of the United States Auxiliary may be amended or altered by the National Convention only every five (5) years
 - 1. Starting with the year 1950
 - 2. Provided, however, that such amendments have been forwarded through channels
 - 3. Have been properly approved
 - 4. Have been proposed by an Auxiliary, a County Council, a District, a Department
 - 5. Have been recommended by a National Officer or the ritual revision committee.
- B. National Headquarters will change the Ritual to be in compliance with the Bylaws.

End of Article XII.

**BOOKLET OF
INSTRUCTIONS
for
DISCIPLINE &
DISCIPLINARY ACTIONS**

Veterans of Foreign Wars
of the United States Auxiliary

July 26, 2023

BOOKLET OF INSTRUCTIONS FOR DISCIPLINE VFW AUXILIARY

DISCIPLINE

Discipline of Members

It is the purpose of this Article to provide a procedure whereby a member may be appropriately disciplined while assuring that such member is given reasonable notice of the charges against them and afforded an opportunity to request that such charges be heard and determined at a Disciplinary Hearing. Except as otherwise specifically provided in Sections of the Bylaws and this Booklet of Instructions, no member may have their membership terminated or suspended nor may any member be relieved of any office unless such discipline is imposed as provided in Article X.

This Article does not apply to action taken by an Auxiliary, District or Department to bar or suspend members from participating in activities or use of clubrooms sponsored or conducted by such Post, District or Department; such actions are subject to separate regulation by the pertinent Post, District or Department.

The following forms, as they may be revised from time to time, will be used in conjunction with this Section:

- Incident Report (DA-1);
- Special Order Initiating Disciplinary Action (DA-2);
- Charges and Specifications (DA-3);
- Request and Record of Mediation (DA-4);
- Request for Hearing (DA-5);
- Order Appointing a Disciplinary Hearing Panel and Special Order (DA-6);
- Findings and Sentence (DA-7);
- Form of Record of Disciplinary Action (DA-8);

Forms are available from National Headquarters

Offenses

Are there reasonable grounds to believe that an offense has been committed by person charged? The recognized offenses shall be as provided in Section 1002 of the Auxiliary Bylaws.

Procedure for Disciplinary Actions:

Part 1—Initiating and Executing (DA-1)

(a) Who May Initiate. (See Section 1003 Bylaws.)

(b) How To Initiate. Charges and Specifications shall be signed by the Initiating Officer and attested to by the Secretary and shall include a copy of the Incident Report (DA-1).

(c) Charges and Specifications. Initiation of a Disciplinary Action requires delivery to each accused of written Charges and Specifications. (See Sample of Charges and Specifications which follows the form DA-3.)

(d) How To Prepare. The President or the designated member initiating a disciplinary action should do so by issuing a Special Order (Form DA-2) which will have attached to it the Charges and Specifications (Form DA-3).

(e) How To Deliver. The Special Order (DA-2), Charges and Specifications (DA-3) and Request for Mediation (DA-4) or a request for a Disciplinary Hearing (DA-5) will be sent to the accused. This may be delivered personally, or by registered or certified mail, return receipt requested to the accused member's last known address. Documentation of delivery shall be retained by the Auxiliary Secretary.

(f) Mediations.

The Mediation Officer is designated by the Department President and approved by the National President. If the Department President is the accused the Mediation Officer is selected by the National President. The Mediation Officer shall schedule a meeting date within thirty (30) days of the request. The mediation shall include the following individuals: the Initiating Officer, the Mediation Officer, and the Accused, plus representation for either. If an agreement is reached during mediation, the penalty imposed is binding and not subject to appeal. The result shall be recorded on Record of Mediation (Form DA-4).

Transcript of the proceedings shall be audio or video tape with speakers clearly understood or professional transcriber. Transcripts become part of the permanent record.

Part 2—Hearings (DA-5)

(g) How Hearings Are to Be Requested. A request (Form DA-5) must be made in writing and mailed by registered or certified mail, return receipt requested, postmarked no later than thirty (30) days from the receipt of the Charges and Specifications and must be addressed to the President initiating the action or, in the event that the charges are not initiated by the President, to the person initiating the charges.

(h) Procedure Where Charges are Not Contested. (See Section 1003 Bylaws.)

(i) Procedure — Disciplinary Hearing Requested. In the event that the accused member requests a Disciplinary Hearing within thirty (30) days and in the manner prescribed above, the following procedures apply: (See Part 3-How to Handle a Hearing)

- Keep in mind if the accused does not request an appeal, they need to be notified of any action taken and their right of appeal of the penalty. This must be sent by certified mail, return receipt requested.
- A copy must be made and forwarded to the next higher authority (Department, National).

Part 3—How to Handle a Hearing (DA-6 and DA-7)

1. Appointment of Panel. If the action is initiated at the Auxiliary level, the Department President will select the disciplinary panel members, date, time and location by issuance of an order. The order shall detail at least seven (7) members to the panel. (DA-6)

Qualifications of Panel Members

- In the event that the Department President initiating the disciplinary action is the accuser, the National President will issue the order.
- If the President initiating the disciplinary action or appointing the panel expects to be a witness with respect to factual matters, the President should request that the order appointing the panel be issued by higher authority. That request will be in writing.

Only members of the Veterans of Foreign Wars of the United States Auxiliary in good standing may sit on a Disciplinary Hearing Panel. No blood relative of the accused or any accuser or witness for the prosecution shall be appointed to the panel.

The same panel may be appointed to hear more than one (1) case. Related cases may be heard at the same time, provided that the Recording Officer maintains a complete and separate record for each accused. In the event that appointees are unable to serve or the time or place of a hearing must be changed, a supplemental order may be issued.

a. President. (Specified in Form DA-6) Is the presiding officer over the panel and not subject to challenge. They shall be acquainted with the hearing procedures, maintain order and give the necessary directions for the conduct of the proceedings.

The President shall rule upon all questions concerning the admissibility of evidence, the competency of witnesses, continuances, adjournments, recesses, motions, challenges and orders, the propriety of any argument or statement of counsel and on any other matter deemed appropriate for the official and efficient conduct of the hearing.

The president of the panel shall take notes or cause notes to be taken that summarize the substance of the testimony of the witnesses and exhibits, the arguments of counsel, the objections and rulings on matters brought to the attention of the panel and other matters of significance occurring in the course of the proceedings.

b. Prosecutor. (Specified in Form DA-6) They shall not be a member of the panel. The prosecutor should not be a witness with respect to disputed factual matters. They may, however, provide evidence concerning procedural matters. They shall provide to the Defense Counsel a list of all witnesses and evidence to be presented not less than thirty (30) days prior to the hearing. They shall present the evidence supporting the Charges and Specifications, even if the member has pled guilty.

c. Defense Counsel. (Specified in Form DA-6) The accused shall select their own professional or lay counsel. The accused may employ or select a private lawyer at their own expense. Accused may serve as their own Defense Council. Defense Counsel shall not be a member of the panel nor an accuser. Defense Counsel should not be a witness with respect to disputed factual matters. He or she may, however, provide evidence concerning procedural matters. They shall provide to the Prosecutor a list of all witnesses and evidence to be presented not less than thirty (30) days prior to the hearing.

2. Continuance. The President may, for reasonable cause, postpone and/or reschedule the hearing. A party desiring that the President postpone or reschedule the hearing shall make such request in writing, stating the reasons for such request. All parties and panel members shall be advised in writing of the rescheduled date.

3. Recording Officer. The Recording Officer shall record all the proceedings and the recordings shall be retained and included as record. Can be recorded by the following means: tape recorder, video recorder and remote teleconference. The recording officer should take reasonable steps to assure that all testimony is recorded and that all speakers and exhibits are adequately identified in the record.

Any notes taken by the President shall be retained with the record of the proceedings.

A complete record should include copies of:

- a.** Incident Report (Form DA-1)
- b.** Special Order advising of the initiation of a disciplinary action. (Form DA-2)
- c.** Charges and Specifications. (Form DA-3)
- d.** The written statement that the Charges and Specifications have been personally served, mailed, or

e-mailed to the accused in accordance with the Procedure for Disciplinary Action.

e. The request for Disciplinary Hearing made by the accused. (Form DA-5)

f. The order appointing the Panel. (Form DA-6)

g. The tape recording or videotape of the proceedings.

h. The President's notes of the proceedings.

i. Any exhibits admitted into evidence.

j. The findings and sentence. (Form DA-7)

k. The form of record of disciplinary action. (Form DA-8)

The record shall be provided to the accused for purposes of appeal and delivered to and maintained by the Auxiliary, Department and National Secretary.

(i) Procedure at Hearing. In the event that a Disciplinary Hearing is requested, the procedure for conducting such hearing shall be as follows:

1. Selection of the Panel – Challenges. The entire panel shall initially be seated.

Each side may challenge any member or members, but those members may be removed only for good cause. Good cause includes, but is not limited to, prejudice for or against a party, financial or other interest in the outcome or inability to afford an impartial hearing. The challenging party shall state the reasons upon which that party believes good cause exists. When a member of the panel is challenged for cause, the President of the panel will decide on the question. No further panel member may be excused for cause when the effect is to reduce the number of panel members below three (3).

Members of the panel shall swear or affirm that they will judge the case fairly and impartially. The panel should protect every witness from insulting or improper questions, harsh or insulting treatment and unnecessary inquiries into private affairs. It should also forbid any inquiries into irrelevant matters intended to merely annoy witnesses or other pertinent parties.

2. Plea to the Charges. After the panel is confirmed, the Charges and Specifications shall be read to the accused by the President unless the accused advises the panel that they have read the charges and they need not be read. The accused shall be required to plead guilty or not guilty to each charge and specification separately. The plea will be recorded on the Form of Record of Disciplinary Action (DA-8).

3. Objections. If there have been procedural errors in initiating the disciplinary action, preparing and delivering the Charges and Specifications, appointing the panel, scheduling the time and place of the hearing or any other matter occurring prior

to the hearing, Defense Counsel or the accused must make their objections known to the panel before the opening statements are given and evidence heard. Similarly, objections must be made to errors in procedure or in the admission of evidence occurring during the course of the hearing at the time of the error. Unless objections are timely made, the alleged error will not be considered in the event of an appeal.

4. Opening Statement. The Prosecutor, followed by the Defense Counsel, shall be permitted to make opening statements which outline for the panel what each believes the issues to be and what each expects to show by the evidence to be introduced.

5. Order of Presentation. The prosecutor introduces evidence first. When the prosecution rests, the defense may introduce its evidence. The prosecutor may then present evidence to rebut such evidence as may have been presented by the defense and the defense shall be given an opportunity to rebut any rebuttal evidence presented by the prosecution. Counsel for both sides shall have the opportunity to cross-examine each witness after direct testimony is given.

6. Rules Concerning Evidence. Evidence may be testimonial or documentary. Testimonial evidence is evidence given in the form of testimony by witnesses. All testimony shall be taken under oath or affirmation by all parties testifying.

7. Documentary Evidence. Includes items other than documents, and is presented in the form of exhibits which show or demonstrate factual matters. An adequate showing of authenticity (i.e., that the document is an original or a true and correct copy of the original) must be made with respect to documentary evidence. A Disciplinary Hearing Panel may base its decision on either direct or circumstantial evidence. Direct evidence consists of testimony or documents which, if believed, would directly prove or disprove facts.

Circumstantial evidence consists of testimony or documents which, if true, would prove or disprove facts or circumstances from which, either alone or in connection with other facts, the existence or nonexistence of a fact in issue could be inferred.

Hearsay evidence consists of testimony based upon the out-of-court statements of persons or documents, i.e., what some other person told the witness or upon something seen by the witness in a document that is not presented. The reason that hearsay testimony is given less credence is that there may be no opportunity to cross-examine the person who actually heard or saw the incident or wrote the document. While hearsay evidence can be considered by the Disciplinary Hearing Panel because of a belief that a sufficiently trustworthy basis exists for considering the evidence,

it should be considered with an appreciation that the evidence is less credible. Hearsay evidence may be fully considered without that limitation if the witness is testifying concerning something the accused has said or the evidence consists of reinforcing documents or letters prepared or signed by the accused.

Books of account or business records are generally admissible. Evidence must be relevant and material. Evidence is not relevant or material when it does not tend to prove or disprove an issue in the case or the President rules that it's not material to the issue at hand.

The panel will exclude improper evidence to which an objection is sufficiently made. It may, on its own initiative, exclude other improper evidence. Excluded evidence should not be considered by the Hearing Panel. The President should note any evidence which was offered but excluded, giving the reason therefore, and any instances where objection was made but the evidence was admitted over such objection, noting the objection.

8. Closing Arguments. After both sides have rested, the prosecution commences its closing arguments. The defense follows and the prosecution closes with rebuttal argument.

9. Deliberations of the Panel. The panel sits in closed session during the deliberation on the findings and sentence. This should include full and free discussion of the evidence at hand. The panel must consider each charge and specification separately and make a determination whether the accused is guilty or not guilty on each charge and specification.

In deciding the case, the sentence should be commensurate with the offense committed. In any event, each case shall be decided on its own merits and the panel shall give due regard to all of the circumstances.

a. Reasonable doubt. In order to convict the accused of an offense, the panel must be reasonably satisfied that the accused is guilty of the offense.

b. Two-thirds Majority Required. There must be a two-thirds (2/3) majority vote in order to convict on any charge and specification. If, in computing the number of votes required, a fraction results, such fraction will be counted as one (1); thus, where five (5) members are to vote, the requirement that two-thirds (2/3) concur is not met if less than four (4) concur. The sentence must likewise be determined by a two-thirds (2/3) majority vote.

10. Findings and Sentence (DA-7). The findings and sentence shall be announced by the President in open hearing after deliberations are complete. In the event the accused or

their counsel was not present at the hearing but the accused has been found either guilty or not guilty, a copy of the Findings and Sentence (Form DA-7) shall be mailed to the last known address within seven (7) days after the hearing.

11. Record of Hearing of Disciplinary Actions (DA-8).

In addition to the notes to be maintained by the President of the panel, the president shall also prepare a Form of Record of Disciplinary Actions (Form DA-8).

**Part 4—How to Handle an Appeal
Appeal**

Any member on which Disciplinary Action is taken under this Article shall have the right to appeal such action.

(a) Appeals From Auxiliary Actions. Appeals to the Department President shall be made within thirty (30) days of the imposition of penalties by a Disciplinary Hearing Panel or, in the case when no hearing is requested, the imposition of penalties by the Initiating Officer or Auxiliary.

All appeals shall be made in writing and be mailed by registered or certified mail, return receipt requested, to the Department President at the Department Headquarters.

The written appeal shall:

1. State the facts of the case based on the evidence introduced at the hearing (if a hearing has been held).
2. Make a clear and concise statement of the reason or reasons upon which the member claims the case was erroneously decided.
3. State the relief requested by the member. Failure of the member to address any one of the aforementioned requirements in their appeal are grounds for denying the appeal.

Upon receipt of a proper written appeal, the Department President shall request that the Department Secretary maintaining the Trial Record forward the same to them within thirty (30) days. The Department President will also provide a copy of the written appeal to the prosecutor, who shall have thirty (30) days from the receipt of the copy to make a written response directly to the Department President. The prosecutor will also mail a copy of their written response to the accused. The accused or their counsel shall then have fifteen (15) days from the date of such response to make a further written submission to the Department President. Once accomplished, the Department President shall decide the appeal and inform the accused and the Auxiliary President in writing as to their determination. The decision of the Department President is final unless within thirty (30) days an appeal is made to the National President. Such an appeal must be made in writing and

mailed by registered or certified mail, return receipt requested, to the National President at National Headquarters in Kansas City. The appeal must include the three (3) criteria listed above.

Upon receipt of a properly written appeal, the National President shall request that the Department President forward to them the Trial Record, together with any papers submitted by the parties on appeal. The National President will, within thirty (30) days, decide the matter and inform the member, the pertinent Auxiliary President and the Department President of that decision. The decision of the National President is final unless an appeal is made to the National Council of Administration within thirty (30) days of the National President's decision. Such appeal shall be in writing and shall be mailed by registered or certified mail, return receipt requested, to the Chairman of the Committee on Appeals of the National Council of Administration at National Headquarters in Kansas City. The appeal must include the three (3) criteria listed above.

Upon receipt of a properly written appeal, the Chairman of the Committee on Appeals shall request the National President forward the Trial Record and any papers submitted by the parties on appeal. The Chairman shall advise the committee members of a time and place that the matter will be considered and decided. The member shall have the right to appear, at their own expense, personally or by counsel, at such time and place as the matter is considered. Upon a recommendation by the Committee on Appeals, The National Council of Administration shall decide the appeal and subsequently inform all concerned of its decision in writing.

(b) Appeals From Department President Actions.

Appeals from disciplinary actions initiated by the Department President shall be to the National President. Such an appeal must be made within thirty (30) days of the imposition of sentence by the Disciplinary Hearing Panel or, where no Disciplinary Hearing is requested, the imposition of penalty. All appeals will be made in writing and shall be mailed by registered or certified mail, return receipt requested, to the National President at National Headquarters in Kansas City. The appeal must include the three (3) criteria listed at the top of page 120.

Upon receipt of a properly written appeal, the National President shall request that the Secretary maintaining the Trial Record forward the same to them within thirty (30) days. The National President will provide a copy of the written appeal to the prosecutor, who shall have thirty (30) days from the receipt of the copy to make a written response directly to the National

President. (A copy will be mailed to the accused and their counsel.) They shall have thirty (30) days to submit a reply. Thereafter, the National President shall decide the appeal and inform the accused and the Department President. The decision of the National President is final unless an appeal is made to the National Council of Administration within thirty (30) days. Such appeal shall be made in the manner specified in the foregoing subsection (a) for appeals to the National Council of Administration for cases initially appealed to the Department President.

(c) Appeals From National President Actions. Appeals from disciplinary actions initiated by the National President shall be to the National Council of Administration.

Such an appeal must be made within thirty (30) days of the imposition of sentence by the Disciplinary Hearing Panel or, where no hearing is requested, the imposition of sentence by the Initiating Officer. All appeals shall be in writing and mailed by registered or certified mail, return receipt requested, to the Chairman of the Committee on Appeals of the National Council of Administration at National Headquarters in Kansas City. The appeal must include the three (3) criteria listed in Section above.

Upon receipt of a properly written appeal, the Chairman of the Committee on Appeals of the National Council of Administration shall request that the Secretary maintaining the Trial Record forward the same to the National Secretary within thirty (30) days.

The Council will provide a copy of the written appeal to the prosecutor who may, within thirty (30) days, submit a written response directed to the National Council of Administration. If a response is submitted, it shall be mailed to the accused and Defense Counsel, who may file a response thereto within ten (10) days.

The National Council of Administration shall advise the member of a time and place that the matter will be considered and decided. The National Council of Administration shall determine the manner in which the matter will be considered. The member shall have the right to appear, at their own expense, personally or by counsel, at such time and place where the matter is considered.

Upon recommendation by the Committee on Appeals, the National Council of Administration will decide the appeal and subsequently will inform the accused in writing of its decision. That decision is final unless an appeal is filed within thirty (30) days to the National Convention.

(d) Timeliness of Appeals to the National Council of Administration: Normally, appeals received greater than thirty (30) days before the next scheduled regular meeting will be heard at that meeting. Appeals not within this timeframe may, at the discretion of the National President, be referred to the council for deliberation at a future scheduled meeting.

Suspension from Office

To effect a suspension under Section 1005 of the Bylaws, the National President, or the Department President having jurisdiction, will inform the member in writing and notify the respective Auxiliary, or Department President of such action.

The National President or Department President is not required, however, to suspend the accused member in every instance. They may use their discretion in determining whether or not such suspension is necessary or appropriate.

Prima Facie Case

The term “prima facie” is a legal term used to describe something that is legally sufficient to establish a fact or a case unless disproved. If an accused member has been convicted by a court of law of a felony, misdemeanor or even an ordinance violation, and will not be available for, a disciplinary action, the disciplinary action may still be initiated and conducted in the same manner as any other. Under this Section of a Prima Facie case, it would not be necessary for the prosecutor to prove again what the civil authorities have already established in the criminal trial. To establish guilt at this disciplinary hearing, all the prosecutor needs to do is present a certified copy of the court record of conviction. The burden then shifts to the accused or their counsel to show that the record of conviction is not a true and correct record.

Penalties

(See Section 1007 Penalties, National Bylaws.)

Administrative Actions

(See Section 1008 Administrative Actions, National Bylaws.)

SPECIAL ORDER INITIATING DISCIPLINARY ACTION

Special Order No. _____

Date _____

Headquarters, VFW Auxiliary No. (or Department) _____

To: _____

A disciplinary action has been initiated against you pursuant to Article XI of the Bylaws and Booklet of Instructions of the Veterans of Foreign Wars of the United States Auxiliary. Attached to this order is a copy of the Charges and Specifications (Form DA-3) and Request for Hearing (Form DA-4).

You must notify _____ in writing, within thirty (30) days of the date that this order and the attached Charges and Specifications were delivered to you. If you do not, disciplinary penalties may be imposed without these proceedings. Penalties may include termination or suspension of membership and relief from office.

By order of _____

President, Auxiliary to VFW Post No. _____
(or Department)

Official _____ Secretary

DA-2

CHARGES AND SPECIFICATIONS

Charge (1): _____

Specification (1): _____

Specification (2): _____

Charge (2): _____

Specification (1): _____

Specification (2): _____

On my oath or affirmation as a member of the Veterans of Foreign Wars of the United States Auxiliary, I declare that I have a reasonable belief that the above described act or acts have been committed.

Initiating Officer

Accuser(s)

Date _____
(If additional Charges and Specifications are required, continue on a separate page and attach to this form.)

DA-3

EXAMPLE -- CHARGES AND SPECIFICATIONS

Charge (1): Violation of Article XI, subsection 8 of Section 1102 of the National Bylaws, Veterans of Foreign Wars of the United States Auxiliary --Selling or otherwise disposing of money or property without proper authority or willfully or negligently damaging, destroying, or losing any such money or property belonging to the Auxiliary, or any other Auxiliary, County Council, District, or Department.

Specification (1): In that Brother/Sister _____, then Treasurer of _____, VFW Auxiliary No. _____, did at (city), on or about the ____ day of (month, year), convert to his/her own use and benefit the proceeds of a check drawn on the account of _____ and payable to Auxiliary _____, in the sum of _____, which check was intended to be a dues payment which Brother/Sister endorsed and collected for himself/herself without proper authority, thereby disposing of money or property belonging to the Auxiliary.

Specification (2): In that Brother/Sister _____, then Treasurer of _____, VFW Auxiliary No. _____, did at (city), on or about the ____ day of (month, year), convert to his/her own use and benefit the funds of said Auxiliary in the account of _____ in that Brother/Sister improperly drew a check payable to himself/herself on that account _____, thereby disposing of the property of the Auxiliary without proper authority.

Charge (2): (Charges and Specifications may continue as needed with Charges being numbered consecutively and the Specifications numbered consecutively under each Charge. When the Charges and Specifications are completed, the sentence below follows with a place for accuser(s) and the Initiating Officer to sign and date as shown in Sample DA-3.)

On my oath or affirmation as a member of the Veterans of Foreign Wars of the United States Auxiliary, I declare that I have a reasonable belief that the above described act or acts have been committed.

Initiating Officer

Accuser(s)

Date _____

PART 1
REQUEST FOR MEDIATION

I am requesting Mediation.

(Accused)

Date

(Note: This request must be mailed within 30 days of receipt of Charges and Specifications.)

PART 2
RECORD OF MEDIATION

As a result of mediation having now been completed, the following is the result agreed upon by all parties:

All parties concerned understand that this form (DA-4) and all other documents related to this action must be forwarded to the National President, for the issuance of a Special Order imposing the above agreed upon penalty. **There is no further appeal.**

_____ No agreement has been reached during this mediation session.

The accused now has the right to request a hearing, which must be done within thirty (30) days.

(Mediation Officer)

(Initiating Officer)

(Accused)

Date

DA-4

REQUEST FOR HEARING

I have received Special Order No. _____ dated _____ with attached Charges and Specifications, indicating that a Disciplinary Action has been initiated.

- An agreement was not reached during mediation. As a result, I request a Disciplinary Action hearing.
- I request a Disciplinary Action hearing.

(Accused)

Date

(Note: This request must be mailed within thirty (30) days of receipt of Charges and Specifications or of unsuccessful mediation to the person initiating the Special Order.)

DA-5

ORDER APPOINTING A DISCIPLINARY HEARING PANEL AND SPECIAL ORDER

No. _____
Headquarters, Auxiliary to Veterans of Wars Post No. _____
Department of _____
Place _____
Date _____
Upon orders of _____, President of _____, Veterans of Foreign Wars Auxiliary, a Disciplinary Hearing Panel is appointed to meet at _____ on _____, 20____, or as soon after this date as practicable for the purpose of trying such person or persons as may be properly brought before it, including: _____

DETAIL FOR THE PANEL

Brother/Sister _____ of Aux No. _____
Brother/Sister _____ of Aux No. _____
Brother/Sister _____ of Aux No. _____
Brother/Sister _____ of Aux No. _____
Brother/Sister _____ of Aux No. _____
Brother/Sister _____ of Aux No. _____
Brother/Sister _____ of Aux No. _____
Brother/Sister _____ of Aux No. _____
Brother/Sister _____ of Aux No. _____
Brother/Sister _____ of Aux No. _____
Brother/Sister _____ of Aux No. _____

Brother/Sister _____ of Aux No. _____, President of Panel
Brother/Sister _____ of Aux No. _____, Prosecutor
Brother/Sister _____ of Aux No. _____, Defense Counsel

By order of _____
President of _____

Official Secretary _____

FINDINGS AND SENTENCE

The panel was closed (or adjourned for the purpose of taking a ballot) and reported back as follows:

On all Charges and Specifications: _____

On Charge 1, Specification 1: _____

On Charge _____, Specification _____ : _____

On Charge _____, Specification _____ : _____

On Charge _____, Specification _____ : _____

On Charge _____, Specification _____ : _____

On Charge _____, Specification _____ : _____

On Charge _____, Specification _____ : _____

(attach additional sheets, if necessary)

The panel imposed the following sentence: _____

Prosecutor

President of the Panel

Date

Note: A copy of this form will be handed to or mailed to the accused at the last known address within seven (7) days after the hearing.

DA-7

FORM OF RECORD OF DISCIPLINARY ACTION

Proceedings of a Disciplinary Hearing Panel convened at _____

on _____, 20_____, pursuant to an order issued by _____

PRESENT

Brother/Sister _____ of Aux No. _____, President of Panel
Brother/Sister _____ of Aux No. _____, Prosecutor
Brother/Sister _____ of Aux No. _____, Defense Counsel
Brother/Sister _____ of Aux No. _____, Member
Brother/Sister _____ of Aux No. _____, Member
Brother/Sister _____ of Aux No. _____, Member
Brother/Sister _____ of Aux No. _____, Member
Brother/Sister _____ of Aux No. _____, Member

ABSENT

Brother/Sister _____ of Aux No. _____, Reason: _____
Brother/Sister _____ of Aux No. _____, Reason: _____
Brother/Sister _____ of Aux No. _____, Reason: _____
Brother/Sister _____ of Aux No. _____, Reason: _____

The accused received notice of the charges and specifications in accordance with Section 1103 of the National Bylaws and requested a hearing: Yes _____ No _____

Challenges for cause were made on panel member(s) _____

Such challenges were sustained as to panel member(s) _____

The members of the panel were sworn. Yes _____ No _____

The Charges and Specifications were read to the accused, or the accused stated that he/she had read the charges, and he/she responded as follows:

PLEAS

To all Charges and Specifications: _____

Or

To Charge _____, Specification _____: _____

To Charge _____, Specification _____: _____

To Charge _____, Specification _____: _____

The following witnesses testified: _____

The following documents were used in evidence: _____

The defense was given full opportunity to examine each witness. Yes _____ No _____

The rights of the accused as a witness were explained to him/her. Yes _____ No _____

An argument was made by the Defense Counsel on behalf of the accused. Yes _____ No _____

The accused did (not) take the witness stand in his/her own defense.

The accused was (not) present at the trial.

President

Date this report was prepared

DA-8 Page 2

INDEX for BYLAWS

TOPIC	PAGE(S)
Absence from	
Auxiliary Meeting.....	68
Council of Administration	49
District	38
Department	43
Extended Period	75
Installation	63-66
National Convention.....	53
Two (2) Consecutive Meetings.....	68
Voting.....	62-63
Address by Title	93
Admission Fee and Dues.....	12
Amendments	
Bylaws.....	45, 54, 107
Incorporation.....	94-95
Ritual.....	107
Annual Transfers.....	17-18
Appeal	
Disciplinary Action.....	101-102, 116-118
For Funds	93
Application (New Member)	12
Applications on File	15
Duplicate Applications.....	15
Appointive Offices	
District	38, 60
Department	43
List	60
Arrearages	
Affecting Delegates.....	37
District	42
Department	52
Assistant Secretary, Conductor, Guard, Musician and Soloist.....	60
Audit(s)-All Levels.....	86-88
Due Dates of Audits	87
Trustees-All Levels.....	86-88

TOPIC	PAGE(S)
Department Audit Committee.....	47-48
Approval by Council.....	50
National Audit Committee.....	56-57
National Secretary-Treasurer.....	85-86
Department Secretary.....	77
Department Treasurer.....	80-84
Authorization.....	1
Auxiliary	
Emblem.....	97
Motto.....	98
Officers (see Specific Office)	
Seals.....	98
Book Inspection-Security.....	83
Booklet of Instructions for Discipline & Disciplinary Actions..	108-119
Bonds.....	79, 88
Budget(s)	
Annual.....	84
District.....	39
Department Budget Committee.....	48
National Budget.....	57, 84-86
National Budget Committee.....	57
National President Responsibility.....	74-75
Department Treasurer.....	80-84
Bylaws and Resolutions Committee.....	56
Bylaws-Department.....	45
Bylaws-Purchase.....	91
Cancellation (Suspension)	
Auxiliary.....	26-27
National President/C-in-C.....	29-30
Candidates for Membership	
Admission Fee.....	12-13
Application.....	12
Investigation.....	13
Notification-Obligation.....	14-15
Recommendation.....	13
Rejection.....	14-15
Voting on.....	14
Cell Phones.....	91
Change of	
Location.....	30
Name.....	32

TOPIC	PAGE(S)
Chaplain	59, 89
Charter	23-24
Auxiliary	23-28
District	40-41
Charter Fee.....	24
Charter, Surrender (Cancellation)	26-28, 42
Chief of Staff	
Department	88
Deputy.....	89
National.....	89
Children, Caregivers at Meetings	92
Color Bearers, Flag, Banner and POW/MIA Flag Bearers	90
Color of Units.....	99
Committees	
Department	45-49
National.....	56-58
Composition	
District	38-39
Department	43-44
Council of Administration	49-50
National.....	53
Council of Administration	54-55
Conductor.....	59, 89
Consolidation	
Auxiliary.....	26
Past Officers	26
Construction.....	95
Convention(s)	1-2, 21, 33-36, 39-40, 44
Convention Committees	
Department	48-50
National.....	56
Council of Administration	
Department	49-50
National.....	54-56
Credit Cards	72, 79
Debit Cards	72, 79
Delegates	
Arrearages.....	36
Credentials	36
District Meetings and Convention	33
Department Meetings and Convention	34

TOPIC	PAGE(S)
Eligibility	33
Fees and Expenses	34-45
National Convention.....	35
Voting for	36
Robert's Rules of Order.....	94
Department	
Arrearages.....	52
Audit Committee.....	47-48
Budget Committee	48-49
Bylaws.....	45
Committees	45-49
Composition	43-44
Convention Committees.....	45-49
Council of Administration	49-50
Dues	49
Official Visit	50-51
Jurisdiction.....	43
Meetings and Convention.....	44
Program Committees	47
Quorum.....	44
Reports and Remittances.	82
Standing Rules	45
Suspension/Revocation of Charter.....	51
Disbursement of Funds	81
Disposition of Property, National.....	58
Disbandment	28
Disciplinary Action Sample Forms.....	120-128
Discipline (Disciplinary Action)	100
Appeal	103-105
Offenses.....	100-101
Penalties	106
Prima Facie Case.....	106
Procedure	100-102
Hearing.....	103
No Hearing.....	103
Suspension	105
Distribution of Bylaws & Ritual	91
Districts	
Arrearages.....	42
Composition	38-39
Consolidated.....	41

TOPIC	PAGE(S)
Dues	40
Formation and Chartering.....	38
Governing Body.....	38
Meetings and Convention.....	39
Reactivation	42
Quorum.....	40
Standing Rules	40
Suspension and Revocation.....	42
Donations, National.....	93
Due Dates of Audits.....	87
Dues/Admission Fee.....	12-13
Dues	
District	40
Department	49
National.....	54
Duplicate Applications.....	15
Duties of Officers	71-90
Emblem	97-98
Election	60-63
Eligibility	1, 5, 59
Eligibility Guide.....	5-11
Equipment & Supplies	93
Fiscal Year.....	95
Floor Work	92
Forfeiture (Surrender) of Charter	
Auxiliary.....	26-27
District	40-41
Formation	
Auxiliary.....	23
District	38
Department	43
National/Supreme Body	53
Former Members, Rejoin	15
Funds-Disbursement of.....	81
General Orders.....	74
Good Standing	15
Guard	89
Historian.....	90
Incorporation	
Auxiliary.....	94-95
Department.....	94-95

TOPIC	PAGE(S)
Ineligibles, Removing	19
Installation	
Auxiliary	63
District	65
Department	65-55
National	66
Instituting Officer	25
Institution of an Auxiliary	24-25
Investigation, New Member	13
Jurisdiction by Posts	23
Language, prescribed	4
Life Membership	16-17
Life Membership Committee	16
Life Membership Transfer	18
Mailing Lists	93
Maltese Cross	97
Meetings	
Auxiliary	30-31
Children, Caregivers at Meeting	92
District	39-40
Department	43
National	53
Regular and Special	30-31
Members	
Good Standing	15
Rights	20
Rights of Appeal	21
Members at Large, Rights of	20
Membership	
Annual	12
At Large	
Department	12
National	12
Transfer	17-18
Life	16-17
New	12
Transfer	
Annual	17-18
Life Member	18
Nonpaying	18

TOPIC	PAGE(S)
Good Standing	15
Life	18
Refunds-Life	16
Widowers/Widows, Divorces/Divorcees, Common Law Marriage and Same-Sex Marriage.....	19
Membership Dues Cards.....	54
National Dues.....	54
Quorum.....	53
Standing Rules	54
Motto.....	98
Musician & Soloist.....	90
National	
Composition.....	53
Council of Administration.....	54-56
Disbursements.....	54
Disposition of Property	58
Dues	54
Meetings.....	53
National Committees	
Appeals & Grievances	57
Audit.....	56
Budget	57
Bylaws & Resolutions	56
Convention	56
Life Membership.....	58
Program	56
National Home—Soliciting for.....	92
National Treasurer.....	84-86
Notification & Obligation.....	14-15
Objects	2
Officers	
Appointive.....	60
Duties	
President (All Levels).....	67-70, 71-75
Auxiliary	68-69, 71-72
District	69, 72
Department	69, 73
National.....	70, 74
Vice President (All Levels).....	75
Secretary (All Levels)	75-78
Auxiliary	76

TOPIC	PAGE(S)
Officers (Cont.)	
Department	77
National	77
Treasurer (All Levels)	78-79
Auxiliary	79-80
District	80
Department	80-84
National	84-86
Trustees, Duties of (All Levels)	86-88
Chief of Staff	
Department	88
National	88
Deputy Chief of Staff	89
Chaplain	89
Conductor	89
Guard	89
Patriotic Instructor	89
Color Bearers, Flag, Banner and POW/MIA Flag Bearers ..	90
Historian.....	90
Musician, Soloist.....	90
Asst. Secretary, Conductor,	
Guard, Musician and Soloist	90
Elective Officers	
Auxiliary	60
District	60
Department	60-61
National	60-62
Past Officers	67
Past Officers' Pins	97
Removal	68
Resignation.....	67
Vacancies	
Auxiliary	68-71
District	69
Department	69-70
National	69-71
Official Color of Units	99
Official Emblem and Logo	97
Official Legend	
Auxiliary.....	98

TOPIC	PAGE(S)
District	98
Department	98
National.....	98
Official Look	96
Official Name	99
Officers and Members, Rights.....	20
Official Seals	98
Official Visit	50, 74, 92
Organization.....	2
Past Officers	67
Past Officers' Pins	97
Politics.....	93
Procedures	
Cancellation	26-27
Consolidation	26
Disciplinary Action.....	100-106
Election	60
Preamble.....	1
Program Committees	
Department	47
National.....	56
Publishing	91
Quorum	
Auxiliary	32
District	40
Department	44
National.....	53
Reactivation	
Auxiliary	27
District	42
Recommendations.....	13
Refunds, Life Member	16
Rejection	14-15
Removing Ineligibles	19
Reports	
Financial.....	83
Remittances-Dues	82
Rights of Members.....	20
Rights of Members at Large.....	20
Rights of Appeal	21
Relief Fund (Also refer to Booklet of Instructions).....	91
Resignations	67

TOPIC	PAGE(S)
Ritual	
Distribution of.....	91
Purchase.....	91
Rules of Order.....	94
Seals.....	98
Security-Book Inspections.....	83
Solicitation of Funds.....	94
Standing Rules	
Auxiliary.....	31
District.....	40
Department.....	45
National.....	54
Supplies & Equipment.....	93
Surrender (Forfeiture) of Charter.....	26-27, 40
Suspension (Cancellation) by C-i-C/NP.....	29-30
Suspension from Office.....	105
Term of Office.....	66
Titles of Address	
Auxiliary & Department.....	93
Transfers	
Annual.....	17-18
Life.....	18
Trustees, Duties of (All Levels)	
Auxiliary.....	86-88
Bonds.....	86-88
VFW National Home Funds.....	92
Video Conferencing.....	31
Visitations.....	21
Voting on Candidates.....	14
Voting Procedure (Also refer to Booklet of Instructions).....	62-63
What May Be Published.....	91
Widowers/Widows/Divorces/Divorcees.....	19

BOOKLET OF INSTRUCTIONS

Veterans of Foreign Wars
of the United States

AUXILIARY

July 26, 2023

Changes from the Booklet of Instructions, Veterans of Foreign Wars of the United States Auxiliary are noted in *Italics*.

INDEX for BOOKLET OF INSTRUCTIONS

TOPIC	PAGE(S)
National District Council Term Schedule.....	1
Applications	2
Attention	7
Auxiliary Traditions.....	4-5
Auxiliary Treasurer, Duties of.....	18
Auxiliary Treasurer Miscellaneous.....	21-22
Chain of Command/Matters of Concern.....	15
Chance Books, Etc.....	22
Change and Rulings.....	2
Charter Replacements.....	4
Colors and Insignia.....	7
Continuous Membership Pins	22
Correspondence	14-15
Districts.....	29
Delegates.....	4
Department Treasurer, Duties of.....	18
Draping of Charter.....	5
Dues, Remission of.....	3
Duties of All Chairmen	29
Election by Acclamation.....	10
Election of Officers	8
Election Procedure (Two or more Candidates).....	10
Escort of Commander-in-Chief or National President.....	6
Gifts (Presenting)	5
Guests and Visitors Clarification.....	32
Heart Salute/Military Salute.....	7
Installation of Officers	8
Memorial Service	5
National Programs.....	29
Official Look Clarification.....	32-33
Order of Business for Auxiliary	11-14
Parade Rest	7
Relief Fund.....	21
Record Retention Guide	16-18
Sample Auxiliary Audit Forms.....	25-26
Sample Auxiliary Audit Form Instructions.....	27-28
Secretary Minutes.....	11-15
Supplies.....	22
Treasurer's Report.....	19-20
Trustees.....	23-24
Using Proper Channels	15
VAVS Program.....	30-31

National District Council Term Schedule

COUNCIL MEMBERSHIP

NDCM	Department		Year	odd	even
1	New Hampshire	Maine	2023-2025	1	
2	Massachusetts	Vermont	2022-2024		1
3	Maryland	New Jersey	2023-2025	1	
4	Delaware	New York	2022-2024		1
5	Missouri	Illinois	2023-2025	1	
6	West Virginia	Virginia	2022-2024		1
7	Kentucky	Tennessee	2023-2025	1	
8	Alabama	Georgia	2022-2024		1
9	North Carolina	South Carolina	2023-2025	1	
10	Arkansas	Oklahoma	2022-2024		1
11	Iowa	Wisconsin	2023-2025	1	
12	North Dakota	Wyoming	2022-2024		1
13	Kansas	Colorado	2023-2025	1	
14	Idaho	Montana	2022-2024		1
15	New Mexico	Arizona	2023-2025	1	
16	Alaska	Hawaii	2022-2024		1
17	Nevada	Utah	2023-2025	1	
18	Rhode Island	Connecticut	2022-2024		1
19	Louisiana	Mississippi	2023-2025	1	
20	Washington	Oregon	2022-2024		1
21	South Dakota	Nebraska	2023-2025	1	
A	Pennsylvania		2023-2025	1	
B	Michigan		2022-2024		1
C	Indiana		2023-2025	1	
D	Ohio		2022-2024		1
E	Minnesota		2023-2025	1	
F	Florida		2022-2024		1
G	California		2023-2025	1	
H	Texas		2022-2024		1
				15	14

Upon the recommendation of the Veterans of Foreign Wars, Resolution No. 5, as approved at the 2006 National Convention, is deemed an internal policy procedure and not necessary for inclusion in the National Bylaws. Therefore, “any changes to the procedure of handling dues or communications will be directed by the National Secretary/Treasurer through the Treasurer’s Guide, Secretary’s Tips, or special communications sent by National.”

Change and Rulings

No Officer or member, whether on the Auxiliary, District, Department or National level, shall be permitted to change or otherwise instruct or send out rulings that would be contrary to any rules or regulations found in these Bylaws and Booklet of Instructions.

Applications

It is the DUTY of the Investigating Committee to see that the applications are filled out completely BEFORE they are presented to the body for consideration. The following fields are to be completed LEGIBLY on each and every application:

1. Auxiliary Number, City and State
2. Type of Membership (Annual, Life, etc.)
3. Full name of Applicant (spelled correctly)
4. Date of Birth
5. Full address of Applicant - including ZIP code
6. Gender
7. Phone
8. Email
9. Post Affiliated or Non-Affiliated
10. Relationship to Veteran
11. Veteran's Name
12. VFW Membership ID (if affiliated)
13. Post Number (if applicable)
14. Name of campaign ribbons or medals
15. Foreign service dates and locations
16. Signatures of the investigating committee (at least two)
17. Applicant's signature and date
18. Recruited/Recommended by is an optional field
(if included - include their ID #)

If any information is missing from the application, the Investigating Committee, can recommend the application be tabled until the next meeting, so the additional information can be gathered. If all this information is on the application, National and/or Departments must process this as long as it is sent with the proper funds. It is not required to send proof of eligibility with the application to National or Department. National and Departments will take the investigating committee's signature, that proof was considered before presenting to the body for a vote.

In order to process applications timely, it is the DUTY of the Auxiliary Treasurer to be sure all information is on the application, prior to submitting it to Department or National for processing.

MALTA will not allow new applications to be processed if numbers 1-5 are not complete. Therefore, applications not including proper payment and/or not including this information will not be processed until this information and/or proper payment are received by Department or National. Also, the application will be returned if not signed and dated by the investigating committee and/or the applicant.

Applications with other required missing information may be processed. However, it will be up to the Department Treasurer, how the additional information will be procured, i.e. mail, email, phone. National Headquarters will return all applications for missing required information.

Investigating committees are appointed by the Auxiliary President and can change meeting to meeting.

Dues—Remission of

In case of sickness and/or financial hardship the Auxiliary may vote to remit the dues of a member. In such cases the Auxiliary shall pay the Department and National dues and any insurance premium for such member, and the member shall be issued a paid-up dues card for the current calendar year.

Charter Replacements

If for any reason an Auxiliary has to secure a new Charter, the National Treasurer will set the cost.

Delegates

1. The person receiving the highest number of votes serves as first Delegate, and our organization does not have a Chairman of Delegates. Delegate No. 1 is usually responsible for the report to their Auxiliary.
2. In election of Delegates and Alternates refer to Article III. This means that you have as many choices as there are Delegates and Alternates to be elected, and not that you can vote for only one (1) of the nominees. For example: If your Auxiliary is entitled to seven (7) Delegates and seven (7) Alternates and if you abide by the above-mentioned section, there may be any number of members nominated, from fourteen (14) up. In your written ballot you have seven (7) choices out of the entire number nominated. The seven (7) receiving the highest number of votes are declared Delegates and the next seven (7) highest are declared the Alternates.

We do not vote by preference or first, second and third choices.

AUXILIARY TRADITIONS

1. No member is allowed to enter the Auxiliary room during the opening, closing or initiation ceremonies unless required to do so by work of the Ritual, or by order of the President.
2. There shall be no movement or noise when the Chaplain is opening or closing the Bible. This means from the time they rise until they return to their seat and sit back down.
3. No one may move while the flags are on the floor.
4. When a member desires to enter the Auxiliary room while the Auxiliary is in session, they will knock and as soon as possible will be admitted, upon presenting their paid-up dues card for the current calendar year to the Guard. They will proceed directly to a seat.
5. In meetings of the various bodies of this organization, members shall be addressed only as **“Brother”** or **“Sister,”** except when holding office, when they shall be addressed by the title of the office, which they hold, said title to be preceded by the word **“Mister”** or **“Madam.”** The chair should always be addressed as **“Mister/Madam President,”** other Officers with the word **“Mister/Madam”** preceding same.

6. All remarks must be addressed to the President and not by one member to another. A member wishing to address the President, will rise and say “Mister/Madam President,” but shall not speak further until they have been recognized by the President.
7. The voting sign shall be by “Ayes” and “Noes.”
8. It is suggested that the Patriotic Instructor instruct new members how to stand at attention, parade rest, etc. The Patriotic Instructor should also try to read some portion of the Bylaws at every meeting.
9. No alcoholic beverages will be permitted during Auxiliary meetings.
10. Smoking, to include but not limited to tobacco products, e-cigarettes, etc., is not allowed during an Auxiliary meeting.
11. There is no rule or objection to applause while the Flag is in the room, or when Color Bearers enter with the Flags. ***However, members should not clap to the music when guest escorted in.***
12. Gifts are never presented at the Altar, with the exception of the retiring President’s pin, which may be presented to them at the Altar following the Installation of new Officers.

Draping of Charter

See Ritual

Charter should remain draped for a period of thirty (30) days following draping of same. No ceremony is required to remove the drape. At the meeting when the drape is to be removed, the Conductor should remove same prior to opening of the meeting.

Memorial Service

See Ritual

The Memorial Altar cloth should be at least one (1) yard square of white material with a six-inch (6-inch) purple border. No braid or tassels should be on this cloth.

Escort Of Commander-In-Chief Or National President

See Floor Plan 14

When Commander-in-Chief or National President is to be escorted, he or she is given the Aisle of Honor.

President: Mister/Madam Conductor please retire with the Colors to escort our Commander in Chief/National President into the room.

Color Bearer and Conductor retire in the usual manner.

Guard: Madam/Mister President the Conductor with the Colors and our Commander in Chief/National President.

President: You will admit them.

Color Bearer and Conductor proceed directly to the Altar in the usual manner. Once in position, the Conductor speaks.

Conductor: Mister/Madam President, The Commander in Chief/National President.

Color Bearers 3 and 4 immediately lead to directly in front of the President's station - Color Bearers 1 and 2 following, the Conductor with Officer. Upon arriving in front of President's station, Color Bearers 3 and 1 face right - Color Bearers 4 and 2 face left, forming the Aisle of Honor. The Conductor stops at the entrance of the aisle. The CIC/NP passes through the aisle while rendering a salute, stop salute once through, turn left and proceed to the right of the President. The Conductor immediately leads back to the Altar, followed by the Color Bearers, forming a line.

President: Introduce the CIC/NP by name and title to assembly. (Read bio AFTER Officers are seated.)

President: Officers, take your Stations.

Three (3) raps.

President reads bio and allows CIC/NP an opportunity to address the membership.

* Please note: This Honor is not part of the VFW Ritual. The Conductor should explain to the CIC how this works and when to salute, if they are not familiar.

Attention

Attention in the Auxiliary means standing with hands at side, head up with eyes looking straight ahead.

Heart Salute/Military Salute (veterans)

1. During Auxiliary meetings the **Heart Salute or Military Salute (veterans)** shall be used at all times where salute is used.
2. Members of the Auxiliary shall stand and salute the Flag by placing the palm of the right hand flat over the heart when the Flag passes by in parade or Military Salute may be used by veterans.
3. Military Salute—Veterans may salute the U. S. Flag during the ceremony of hoisting or lowering the Flag or when the Flag is passing in review. In addition, a Military Salute may be used during the Pledge of Allegiance and the playing of the National Anthem. The Veterans of Foreign Wars and VFW Auxiliary encourage all veterans to render a salute under these circumstances regardless of their headgear or lack of headgear.
4. When the Flag IS displayed, and the National Anthem IS played and/or sung, all present shall rise, face the Flag and salute—**Heart Salute or Military Salute (veterans)**.
5. When the Flag IS NOT displayed and the National Anthem is played and/or sung, all present shall rise, face the music and salute—**Heart Salute or Military Salute (veterans)**.
6. When Taps is played, all present shall rise, face the Flag and salute—**Heart Salute or Military Salute (veterans)**.

Parade Rest

The left foot is moved slightly to the side while bringing the arms to the small of the back. Place the left thumb in the palm of the right hand. The head is bowed slightly during the prayer.

Official cap/cover will be removed during prayer, only if the VFW or Auxiliary Chaplain reciting the prayer, removes or is not wearing their official cap/cover.

Colors and Insignia

1. All banners for Auxiliaries, Districts and Departments, bearing the Auxiliary emblem, shall be purchased from VFW Supply Department.
2. Auxiliaries are permitted to purchase regulation American Flags from any dealer, but it is recommended that Auxiliaries also purchase the American Flags from VFW Supply Department in order that they shall be comparable with the banner purchased from VFW Supply Department.

Installation of Officers

1. You must request permission from the National President, if you wish to hold a Joint Installation after the **CLOSE** of your Department Convention. The request must be made in advance and should be mailed or emailed to National Headquarters.
2. At an open installation, the giving of the charges by the Installing Officer is optional. If the Post Installing Officer at a joint or open installation requests the Auxiliary Installing Officer to omit the Officers' charges, they should comply with their request, with the exception of the charge to the President. No Officer shall be installed by proxy.
3. At a public installation, the presentation and retiring of Colors and escorting of Officers as prescribed in the Ritual is permitted.
4. The Installing Officer, when giving the Officers' Obligation, should also raise their right hand during the obligation.

Election of Officers

According to established precedent, the following is the procedure in the election of Auxiliary Officers:

1. President announces that the next business in order will be the election of Officers and that while such election of Officers is in progress, no member may enter or leave the room during the election of any **one** Officer except for valid reasons; in which case, they shall not be permitted to re-enter the room until that **one** Officer is elected. Also, after members have voted and the vote is declared closed, a member who has not voted is not permitted to vote.
2. A committee of one (1) Judge and two (2) Tellers is appointed by the President before nominations are opened and the result of the election shall be announced by the Judge. The Judge and Tellers must be members of the Auxiliary, District or Department that is conducting the election. The Judge and Tellers may nominate and vote, but they should not be a candidate for a contested office.
3. Nominations for Officers in National, Department, District, and local Auxiliary may always be made from the floor, or the President's station. Nominations do not have to be seconded.
4. A Presiding Officer shall announce before opening the

nominations: “If there are no objections, the Chair will close the nominations after calling for further nominations three (3) times, following the last nomination for that office.” At a National, Department or District Convention in case of a two (2) day meeting where nominations are held open, nominations could be asked for twice on the first day and only once on the second day, provided another name is not nominated on day two (2). You must call for nominations three (3) times after the last name is nominated.

5. The written ballots may be deposited by each member in a ballot box provided therefore on the Teller’s table, or may be collected by the Conductor by passing the ballot box to each member. After all ballots have been collected, the ballot box shall be placed by the Conductor upon the Teller’s table. After all members have cast their ballot, the President shall declare the ballot closed and then the Judge and Tellers shall proceed to count the ballots.
6. The Judge announces the report of Tellers and the President declares the results of the election.
7. All members in good standing are entitled to vote. No member can be compelled to vote.
 - The President can cast the tie-breaking vote provided the President has not already voted. If the President's vote caused the tie, then the assembly needs to keep voting per Robert's Rules of Order in order to elect that Officer.
 - Per Sec 805 Voting, Auxiliaries vote by written ballot if more than one (1) candidate. On District level, you can vote by roll call or written ballot. If there is a tie, you should vote by written ballot if you have not already done so, as this may break the tie.
 - If after three (3) times, and you still cannot elect, you may by majority vote decide how to break the tie, i.e. flipping a coin, short straw, etc. The Judge should flip the coin or hold the straws or you would continue voting until a winner is declared.
 - **NOTE:** All ballots must be destroyed after the elections are completed.
 - **NOTE:** If voting on a motion and there is a tie, the motion is defeated.

8. The Judge should announce the number of members in room entitled to vote, the number of votes cast, and the number of members not voting.
9. On a roll call vote, the Chairman of the Credentials Committee calls the roll of registered Delegates, giving delegate strength. they announce the close of the roll call.

Election Procedure, Two (2) or More Candidates

Should there be three (3) or more candidates and one (1) or more candidate drops out before the election is concluded, the voting ceases. Then the ballots are cleared and a new balloting begins with the remaining candidates.

Judge: As a courtesy to our candidates, please refrain from applause when the results are announced. You may applaud remarks made by all candidates after they address the delegation.

In the case of ballots cast for two (2) or more candidates, the following is the accepted procedure:

Judge: We find _____ votes for candidate “A”, _____ votes for candidate “B”, votes for candidate “C”, etc.

(During the voting procedure where there are only two candidates for whom ballots are being cast, if one (1) of the candidates withdraws before the roll call vote is completed, the Judge will announce that the remaining candidate is the winning candidate and has been elected by a majority vote.)

By your majority vote, you have elected candidate _____.

President: Brother/Sister, do you accept this election?

Officer-elect: I do, and (words of gratitude and pledge of service.)

President: I herewith declare Brother/Sister _____ duly elected as _____ for the ensuing year.

One (1) rap.

Election by Acclamation, One (1) Candidate

In the case of only one (1) candidate having been nominated for an office, the following is the accepted procedure:

President: Hearing no further nominations, I hereby declare _____ (name) elected by acclamation as _____ (title), for the ensuing year.

President: Brother/Sister _____, do you accept this office?

Officer-elect: I do. (Words of gratitude and pledge of service may be given here by the Officer-elect, but should be very short.)

President: I herewith declare Brother/Sister _____ duly elected as _____ for the ensuing year.
One (1) rap.

Secretary Minutes

- A. The minutes should contain in the first paragraph:
 - 1. Name and number of the Auxiliary.
 - 2. Date and place of meeting.
 - 3. Time called to order.
 - 4. Name of Presiding Officer.
 - 5. Whether regular or special meeting. (If a special meeting, the purpose for which it was called.)
 - 6. Number of members present.
 - 7. Names of visitors, if there are any present.
- B. When the roll is called, the Conductor responds “present” or “absent.” Check your list of Officers, and in the minutes record those absent, as well as the names of those members appointed pro tem. If an Officer is absent, the President appoints a member to fill their station before the meeting starts.
- C. Then the Secretary should write “Opening ceremonies were held, after which the minutes of the last regular meeting were read and approved as read,” or “corrected and approved with the corrections ordered.”
- D. Auxiliary Order of Business
The order of business would be recorded in the minutes as follows:
 - 1. Opening Ceremonies.
 - 2. Introduction of National and/or Department Officers.
 - 3. Reading and Referring of Applications for Membership.
The only part of the card necessary to be read is as follows:
“Jane Doe, 123 Elm Street, eligible through service member John Doe. Recommended by Mary Doe.”
 - 4. Report of Investigating Committee.
The Secretary shall be responsible for seeing that all information is given and the Investigating Committee shall be held responsible for the accuracy of the information and the eligibility of the candidate.
 - 5. Voting on Candidates.
The result of the vote and the names of those initiated should be recorded.

6. Initiation. *(optional)*
7. Presentation of Minutes of Previous Meeting.
 - After you have read the minutes and they have been approved, write the word “Approved” and the date under your signature. If there are corrections note them in the minute book along the margin adjacent to the paragraph corrected.
8. Reading of Official and Other Communications.
 - All communications are grouped under one heading but National letters are read first, Department General Orders and letters second, followed by District communications, Post or other Auxiliary communications, and finally thank-you notes, cards and communications from outside organizations.
 - All General Orders from the Department President are official and must be read at the first meeting following receipt before being filed for reference. All other communications from National or Department Officers are also official and should be read at once. If the communications require action, such action taken is recorded in the minutes.

It might be written thus: “General Orders No. 5 from the Department President were read. There were also letters from National _____ (title), Brother/Sister _____ notifying us that _____” (herein should be given the information contained in the letter). And from Department _____ (title), Brother/Sister _____, asking that we _____ (herein should be given a summary of the information contained in the letters).

9. Treasurer’s Report.

A copy of the Treasurer’s report shall be incorporated in the minutes.
10. Presentation of Bills.

Read the actual bills separately and give the total. The minutes should read something like this: “Bills for \$25.00 were read as follows: _____” (List the bills). No action is taken on the bills at this time. They are simply handed to the Trustees for approval.
11. Introduction of Guests, who are not escorted.
 - At this point in the meeting, any guest(s) may be admitted.

12. Report of Committees, Standing and Special.
The Veterans and Family Support Chairman should be called upon first, citing all inquiries of veterans or families of veterans in distress. All members would report any distress or cases of illness unknown to the Veterans and Family Support Chairman.
Each committee chairman is called on for their report. Note should be made in the minutes of who made the report, and what action is taken. With the exception of the Trustees' report on the audit of the books and on the bills, reports are accepted without motion, unless there is objection from the floor. The Trustees' report on the audit must be accepted by a motion passed by the Auxiliary and the Audit Report shall be incorporated in the minutes.
13. Unfinished Business.
All business held over from a previous meeting now has the floor. Action by motion on items brought up under this heading should be recorded in the minutes.
14. New Business.
(When there has been a death of a member since the last meeting, the first order of new business is the draping of the Charter.)
Elections are also included under new business as well as other business that may be brought up. If election is held, nomination(s) for each office and the results of the election shall be recorded. Any other action taken under new business should be recorded according to the motions passed on the floor.
15. Report of Trustees on Bills and Action Thereon.
The Senior Trustee makes the report if they are present. With reference to the bills presented earlier in the meeting, they will probably say, "The Trustees have examined the bills and recommend that they be paid." A member moves the report be accepted and the bills paid. Another member seconds the motion. The Trustee reporting can also move that the report be accepted and the bills paid.
16. Suggestions for the Good of the Order.
New members and guests should be invited to speak at this time.

17. Closing Ceremonies.

The Secretary should finish minutes by writing something like this: “Closing ceremonies were conducted in accordance with the Ritual, after which the meeting was adjourned. The next meeting will be _____ (date) *at* _____ (*time*).”

E. Body of Minutes.

1. The minutes of each meeting should be signed by the Secretary when recorded and after “approved”, the “date of approval” should be written under the signature.
2. The minutes of each meeting will thus contain a record of all business transacted; all main motions, whether carried or lost; all other motions that were carried, by whom motions were made and seconded.
3. The Secretary should always bring to the meeting all necessary record and minute books and papers which the President is likely to need and any necessary equipment for their own duties.
4. If the Secretary is unable to be present at a meeting, the Auxiliary President shall appoint a Secretary pro tem who shall record the minutes of the meeting at which acted.

The Secretary pro tem also records same in the Secretary’s book, duly signed by them as Secretary pro tem. These minutes will be read at the following meeting for approval by the Auxiliary.

F. It is permissible for a Secretary to tape the minutes of the meeting to supplement their notes.

1. The tapes may not be distributed to those who did not attend the meeting and may not be used for any other purpose than to ensure the accuracy of the minutes.
 - Once the minutes have been approved, the tape should be destroyed or taped over.
2. The recording equipment should be in full view of the members and should not be used if any member objects. Individual members may not be allowed to tape the meetings for their own personal use, ***unless the body approves per Bylaw Section 210.***
3. Members may review the minutes as recorded by the Secretary in their official Record Book.

G. Correspondence.

1. All correspondence written for the Auxiliary should bear

the Auxiliary name, number and location in the heading. Each letter should bear the date it is written.

2. If the letter is written in accordance with action taken at an Auxiliary meeting, then reference should be made to the date of the meeting. Thus: "In accordance with action taken at a regular (or special) meeting of _____ VFW Auxiliary to Post No. _____ on _____ (date), I am writing _____," and so forth.
3. Each letter should bear the full name and address of the Auxiliary Secretary, or whoever writes the letter.
4. Official correspondence shall be signed by the Secretary. For clarity, the name and title should be typed and then signed in ink, thus:

(Signature)
Mary Doe, Secretary
VFW Auxiliary # _____
1313 E. 13th St.
Podunk Center, MO 64112

5. One subject to a letter! If you are writing to your Department Secretary asking a question and notifying him/her of a change of address, send two different letters. Both letters may be placed in the same envelope.
6. Letters of personal interest or beliefs should **not** be sent on Auxiliary letterhead and/or signed with Officer title.

Chain of Command/Matters of Concern

Using Proper Channels

1. Those concerns, problems, etc. of an Auxiliary MAY be addressed to the District President who will take ***their*** concerns directly to the Department President for consideration. If the concern is in regard to the District President, the Auxiliary may go directly to the Department President.
2. The Department President then decides who should be assigned to handle the concerns of that particular Auxiliary.
3. If the concern warrants it, the Department President may address it to the National President for ***their*** consideration.
4. It is the practice of National Headquarters that a Department President have the first opportunity to assist Auxiliaries and members of ***their*** Department. Therefore, any correspondence received from an individual, Auxiliary or District will be referred to the Department President so that ***they*** have the first opportunity to assist or fulfill a request.

RECORD RETENTION GUIDE

The following guidelines have been developed in response to requests from Auxiliaries and Departments as to how long to retain certain files and records. This list includes some records to be retained by all businesses including Auxiliaries, and some records that relate only to our organization.

For federal tax purposes, the general statute of limitations is three years after the return due date, including extensions; however, there are situations in which the statute of limitations will be extended to six years or even indefinitely. In addition to federal laws, each state also has its own laws regarding record-keeping requirements. If you have limited storage space, you might consider scanning some documents to a CD and storing the originals off-site.

<u>Record Name</u>	<u>Minimum Suggested Retention Period</u>
Accounts payable invoices	6 years
Accounts payable ledger	6 years
Accounts receivable ledger	6 years
Audit reports	6 years
Bank deposit slips	6 years
Bank statements and reconciliations	6 years
Bonds (i.e. Treasurer's Bond Receipt)	3 years after expiration of policy
Budgets	6 years
Bylaws	6 years
Cancelled checks	6 years
Cash receipt records	6 years
Charter	Permanent
Contracts	6 years after the termination or completion of contract
Correspondence, general	1 year
Depreciation schedules	The later of 6 years of the asset being fully depreciated or disposal of the asset
Detailed fixed asset records	The later of 6 years of the asset being fully depreciated or disposal of the asset
Disbanded Auxiliary Records	7 years
Disciplinary Action file	1 year from completion
Election of Officer reports	6 years
Employee records	6 years after the employment relationship has ended or 30 years if lawsuit or injury

Expense vouchers	6 years
Financial reports	6 years
Garnishments	6 years
General Ledger	7 years
Incorporation papers	Permanent
Inspection reports	1 year
Insurance records, general	3 years after expiration of policy
Inventory records	The later of 6 years after inventory has been used or written off
Lease records	6 years after termination of lease
Membership Applications, Annual and Life	*Until the member has been deceased for 6 years or has reached 120 years of age
Membership Dues Record Cards	*6 years
Membership Listings	*6 years
Minutes of Auxiliary Meetings	*6 years
Payroll register	**6 years
Petty cash records	6 years
Program chairman annual reports	1 year
Standing Rules	6 years
Tax records	7 years
Treasurer reports, monthly	***6 years

*Membership applications should be retained as a permanent record to aid in establishing length of membership, original eligibility, and other items of historical value. Membership listings may be destroyed after six (6) years ONLY if ALL membership applications are permanently retained.

**In some instances, it may be advisable to retain the minutes of Auxiliary meetings permanently when those minutes contain policy decisions. Normally, however, those policy decisions would have been incorporated into the Auxiliary Standing Rules, and the minutes would only be of minor historical significance.

***Monthly Treasurer reports usually prove to be “dead files” once the quarterly and annual audit reports are completed. However, it is recommended that they be retained for a period of six (6) years, should a detailed reconstruction of the Auxiliary’s financial situation be required by an auditor or the IRS.

Obviously, the foregoing list is not all-encompassing, nor is it intended to be. A good rule of thumb in determining what files and records to keep is that if the file or record has no financial or historical significance, then it is probably time to dispose of it.

Auxiliary Treasurer, Duties of

1. Under receipts, the Treasurer will report the amount of dues received from each member since the previous meeting. Any discrepancies will be checked immediately. Following the meeting, the Treasurer will enter the dues in the Treasurer's bound ledger, cashbook or in a computerized system.
2. At each Auxiliary meeting, the Treasurer shall make a report following the Reading of the Minutes, which shall contain:
 - a. Balance on hand at last report.
 - b. Amount received from all sources since last report.
 - c. Amount expended since last report.
 - d. Balance on hand.
3. Outstanding checks should be reviewed yearly to see if any check should be voided.

Treasurer's report must show all receipts and disbursements in detail, including name of person or firm to whom check is issued and stating for what purpose.

Department Treasurer, Duties of

The Department Treasurer will maintain a file of audits received from each Auxiliary and District. The Department Treasurer shall review all audits of Auxiliaries and Districts for accuracy and correctness. If an error is found, the Treasurer shall return the audit to the Auxiliary or District to be completed correctly. When the audit is corrected, it shall again be forwarded to the Department Treasurer.

The Department Treasurer shall also review the audit for any other discrepancies which might occur. If the Department Treasurer finds continuous mistakes, inconsistencies, or a serious error, they shall notify the Department President, who will determine what action, if any, is needed at that time.

Following is a recommended format for a Treasurer's Report.

Treasurer's Report
Date of Meeting: Sept. 15, 20XX

GENERAL FUND:

Beginning Balance \$2,000.00

Receipts in detail since last report:

<u>Name</u>	<u>Purpose</u>	<u>Amount</u>
Jane Doe	Admission Fee and Dues	\$20.00
Sally Brown	Dues	15.00
Mary Smith	9/8 Card Party Receipts	150.00
Jean Hall	Sale of Aprons	<u>100.00</u>
Total Receipts since last report		\$285.00

Disbursements in detail since last report:

<u>Name</u>	<u>Purpose</u>	<u>Amount</u>
Harry Jones	Orchestra for dance	\$200.00
Dept. Treas.	Nat'l and Dept. Dues	20.00
H. A. Mills	Hall Rent	150.00
Jones Rental	Chairs & tables for card party	<u>100.00</u>
Less Total Disbursements since last report		(\$470.00)

Ending Balance \$1,815.00

RELIEF FUND:

Balance on hand \$450.00

No activity

CANCER FUND:

Beginning Balance \$0.00

Receipts in detail since last report:

Dance profit	<u>\$275.00</u>
Total Receipts since last report	\$275.00

Disbursements in detail since last report:

VFW Auxiliary National Headquarters \$275.00

Total Disbursements since last report (\$275.00)

Ending Balance \$0.00

TOTAL ALL FUNDS: \$2,265.00

CHECKING ACCOUNT BALANCE: \$2,265.00
No outstanding checks or deposits

INVESTMENTS:
Beginning Balance \$1,184.77
Interest 15.23
Disbursements 0.00
Ending Balance \$1,200.00

TOTAL ALL FUNDS: \$3,465.00

Signed:

Sara Moore, Treasurer

The Treasurer shall give a copy of the report to the Secretary to incorporate into the minutes.

Relief Fund

The Relief Fund shall consist of the proceeds from:

1. Net proceeds from Buddy Poppy distributions.
2. Any contribution or other funds available.

Relief Fund money shall be restricted and expended solely for these purposes:

1. Aid to Auxiliary members needing financial assistance.
2. To meet all obligations or to send monetary gifts to the VFW National Home.
 - a. VFW National Home Health and Happiness through MALTA or mail to 406 W. 34th St., 10th Floor, Kansas City, MO 64111.

The following checks should be made payable to the VFW National Home and mailed to 3573 S. Waverly Rd., Eaton Rapids, MI 48827:

- b. VFW National Home Life Memberships
 - c. VFW National Home Endowment Certificates
 - d. VFW National Home for House Funds
 - e. Direct appeal from VFW National Home
3. Hospital work for all veterans, members of the Armed Forces, Auxiliary Members and their family members.
4. Veterans & Family Support work for all veterans, members of the Armed Forces, Auxiliary members and their families.
5. National Auxiliary Cancer Aid & Research Fund.
6. Special purposes authorized by National Headquarters.
7. To perpetuate the memory of deceased veterans and members of the Armed Forces and to comfort their survivors.
8. To foster true patriotism through historical and educational programs.
 - a. When disbursing Relief Fund money for Items 3 and 4, it must have a direct benefit to veterans and/or their families.
 - b. All other expenditures shall come from the General Fund.

Auxiliary Treasurer Miscellaneous

1. If Past Officers' pins have not been ordered, the Treasurer should remind the Auxiliary that it is time to purchase Past Officers' pins in accordance with the Bylaws. They should order the pins as soon as instructed by the Auxiliary in order to insure delivery before installation.

2. All checks must be countersigned by the President. Treasurer must not sign blank checks, nor shall President countersign blank checks.
3. Auxiliaries may not possess credit cards and/or ATM (Automated Teller Machine) cards.
4. If the Treasurer is unable to be present at a meeting, the Auxiliary President shall appoint a Treasurer pro tem, who shall record the receipts and disbursements. The Treasurer pro tem is not permitted to sign checks in the absence of the Treasurer, as the name of the Treasurer pro tem would not be on record at the bank and checks would not be honored. The Treasurer shall as soon as possible following the meeting at which they were absent, prepare the checks for payment, as indicated on the records given them by the Treasurer pro tem.

Chance Books, Etc.

1. Auxiliary members cannot hold any event in the name of the Auxiliary unless permission has been granted by the Auxiliary. The proceeds must then be turned over to the Auxiliary Treasurer and a report made of same.
2. Auxiliaries are forbidden to send tickets, chance books, punchboards, etc., to other Auxiliaries for resale.

Continuous Membership Pins

Any member who has paid dues for five (5) or more years is eligible for their continuous membership pin. Pins are available in increments of five (5) years. The Auxiliary or Department Treasurer must verify the continuous membership.

These pins do not denote service as an Auxiliary Officer but are a mark of recognition for the continuous membership of any member. They are provided covering five-year (5-year) periods and only one pin bearing the latest five-year (5-year) membership period shall be worn.

Supplies

1. All supplies must be ordered directly from the VFW Supply Department, 406 W. 34th St., Kansas City, MO 64111.
By phone: Member Service Center (MSC) at 1-833-VFW-VETS.
Online: vfwstore.org.

Trustees

1. It is the duty of the Trustees to audit the books. The following shall be brought to the audit for review by the Trustees:
 - a. Secretary's record book
 - b. Treasurer's record book
 - c. Checkbooks
 - d. Bank statements
 - e. Cancelled checks
 - f. Savings account books, if any
 - g. Certificates of deposit or other similar investments, if any
 - h. Cash receipt book
 - i. Membership records, such as Transmittals
 - j. Membership reports available from the National website such as CMR, Monthly Membership Update Report, Monthly Membership Transfers Report, and Monthly Membership Paid Report.
2. The quarterly audit of books is conducted by the Trustees (See Section 814). The President, Secretary, and Treasurer should attend the audit.
3. As stated in Section 814 of the National Bylaws, copies of each Audit must be sent to the Department Treasurer.
4. A check of receipts and expenditures is made. The balance on the Treasurer's records must agree with the balance on the bank statement. The Treasurer's report is compared to the Secretary's books and Standing Rules to be sure all expenditures were voted on. This record is kept by the Secretary in the minutes since they present the bills and balance on hand. A copy of the signed Audit Report must be given to the Secretary to be secured in the official record book.
5. It is not the duty of the Trustees to correct the Treasurer's or the Secretary's records, but the duty of the Treasurer or Secretary. The Trustees check the Treasurer's and the Secretary's books during audit and report their findings in their regular report. If any mistakes are reported, the Treasurer or the Secretary, himself/herself, shall be directed by the President to make the necessary correction(s) in their book. The Trustees shall sign the audit after all mistakes, if any, have been corrected.
6. Notes to help Trustees with the Audit:

Once the Audit is complete, the Senior Trustee should write: Audited and found correct with the Date.

Each Trustee or Trustee Pro-tem should sign with name and Trustees or Trustee Pro-tem on the following documents:

- Audit Form
- Treasurer Record book or print out - Last page of each month audited
- Secretary Record book or print out - Last page of each month audited
- Checkbook - at the place where the last check, during the audit period, was written
- Most current Bank Statement
- The following can be initialed:
 - Any other pages of the Treasurer Book
 - Other Bank Statements
 - Any other pages of the Secretary Book, if the book is not a bound book
 - Any other submitted items from #1 above should be initialed.

Sample forms and instructions may be found on the following pages and in the Treasurer's Guide.

VFW AUXILIARY TO POST NO. _____ DISTRICT _____ DEPARTMENT _____
 DISTRIBUTION OF RECEIPTS, DISBURSEMENTS, AND CASH BALANCE BY FUND

FOR PERIOD OF _____ TO _____

FUND	CASH BALANCE LAST REPORT	RECEIPTS	DISBURSEMENTS	CASH BALANCE THIS REPORT
General Fund	\$ _____	\$ _____	\$ _____	\$ _____
Dept. & Nat'l Dues	\$ _____	\$ _____	\$ _____	\$ _____
Restricted (i.e. Cancer Insur)	\$ _____	\$ _____	\$ _____	\$ _____
Relief Fund	\$ _____	\$ _____	\$ _____	\$ _____
TOTALS	\$ _____	\$ _____	\$ _____	\$ _____
Other (i.e. Cancer Aid)	\$ _____	\$ _____	\$ _____	\$ _____
Other (i.e. National Home)	\$ _____	\$ _____	\$ _____	\$ _____
Other	\$ _____	\$ _____	\$ _____	\$ _____
TOTALS	\$ _____	\$ _____	\$ _____	\$ _____
Savings Account	\$ _____	\$ _____	\$ _____	\$ _____
Total Balance -- All Funds	\$ _____	\$ _____	\$ _____	\$ _____
Including Savings Account	\$ _____	\$ _____	\$ _____	\$ _____

BANK STATEMENT RECONCILIATION

Bank balance as shown on bank statement

Less Outstanding checks:

Check Number _____ \$ _____
 Check Number _____ \$ _____
 Check Number _____ \$ _____
 Check Number _____ \$ _____

Total Amount of Outstanding Checks: \$ _____

Date _____
 Date _____

Total Amount of Outstanding Deposits: \$ _____

Total Adjusted Bank Balance

THIS IS TO CERTIFY THAT THE BOOKS OF THE SECRETARY
 AND TREASURER HAVE BEEN AUDITED, FOUND CORRECT,
 AND ALL MONEYS PROPERLY ACCOUNTED FOR.

DATE AUDIT WAS CONDUCTED _____

TRUSTEES: (sign & date)

VFW AUXILIARY TO POST NO. (A) DISTRICT (B) DEPARTMENT (C)
 DISTRIBUTION OF RECEIPTS, DISBURSEMENTS, AND CASH BALANCE BY FUND

FOR PERIOD OF (D) _____ TO _____ (E)

FUND	CASH BALANCE LAST REPORT	RECEIPTS	DISBURSEMENTS	CASH BALANCE THIS REPORT
General Fund	\$ 1	\$ 12	\$ 23	\$ 34
Dept. & Nat'l Dues	\$ 2	\$ 13	\$ 24	\$ 35
Restricted (i.e. Cancer Insur)	\$ 3	\$ 14	\$ 25	\$ 36
Relief Fund	\$ 4	\$ 15	\$ 26	\$ 37
TOTALS	\$ 5 = Lines 1+2+3+4	\$ 16 = Lines 12+13+14+15	\$ 27 = Lines 23+24+25+26	\$ 38 = Lines 34+35+36+37
Other (i.e. Cancer Aid)	\$ 6	\$ 17	\$ 28	\$ 39
Other (i.e. National Home)	\$ 7	\$ 18	\$ 29	\$ 40
Other	\$ 8	\$ 19	\$ 30	\$ 41
TOTALS	\$ 9 = Lines 5+6+7+8	\$ 20 = Lines 16+17+18+19	\$ 31 = Lines 27+28+29+30	\$ 42 = Lines 38+39+40+41
Savings Account	\$ 10	\$ 21	\$ 32	\$ 43
Total Balance -- All Funds				
Including Savings Account	\$ 11 = Line 9+10	\$ 22 = Lines 20+21	\$ 33 = Lines 31+32	\$ 44 = Lines 42+43

BANK STATEMENT RECONCILIATION

Bank balance as shown on bank statement

Less Outstanding checks:

Check Number	46	\$	47
Check Number	46	\$	47
Check Number	46	\$	47
Check Number	46	\$	47
Total Amount of Outstanding Checks:		\$	48
Date	50	\$	51
Date	50	\$	51
Total Amount of Outstanding Deposits:		\$	52
Total Adjusted Bank Balance		\$	53

Plus Outstanding deposits:

Total Amount of Outstanding Deposits:

Total Adjusted Bank Balance

THIS IS TO CERTIFY THAT THE BOOKS OF THE SECRETARY
 AND TREASURER HAVE BEEN AUDITED, FOUND CORRECT,
 AND ALL MONEYS PROPERLY ACCOUNTED FOR.

TRUSTEES: (sign & date)
 _____ \$ 55
 _____ \$ 55
 _____ \$ 55

DATE AUDIT WAS CONDUCTED _____ 54

Veterans of Foreign Wars Auxiliary Sample Auxiliary Audit Form Instructions

Line Description

- A Auxiliary Number
- B District Number Auxiliary belongs to (if applicable)
- C Department Auxiliary belongs to
- D Beginning date of time period covered by audit (i.e. January 1, 20XX)
- E Ending date of time period covered by audit (i.e. March 31, 20XX)
- 1 Beginning General Fund balance. Also the ending General Fund balance from prior audit (line #34 from last audit report).
- 2 Beginning Dept. & Nat'l Dues balance. Also the ending Dept. & Nat'l Dues balance from prior audit (line #35 from last audit report).
- 3 Beginning Restricted balance. Also the ending Restricted balance from prior audit (line #36 from last audit report).
- 4 Beginning Relief Fund balance. Also the ending Relief Fund balance from prior audit (line #37 from last audit report).
- 5 Sum of lines 1 through 4. Also line #38 from the last audit report.
- 6 Beginning balance of Other Funds (i.e. hospital). Also the ending Other balance from prior audit (line #39 from last audit report). May enter 0.00 if Auxiliary does not have "Other" Funds.
- 7 Beginning balance of Other Funds . Also the ending Other balance from prior audit (line #40 from last audit report). May enter 0.00 if Auxiliary does not have "Other" Funds.
- 8 Beginning balance of Other Funds . Also the ending Other balance from prior audit (line #41 from last audit report). May enter 0.00 if Auxiliary does not have "Other" Funds.
- 9 Sum of lines 5 through 8. Also the ending Other Total balance from prior audit (line #42 from last audit report).
- 10 Beginning balance of Savings. Also the ending Savings balance from prior audit (line #43 from last audit report).
- 11 Sum of lines 9 through 10. Also line #44 from the last audit report. Beginning cash balance.
- 12 Total of all the money received for the General Fund during the audit period.
- 13 Total of all the money received for Department & National dues during the audit period.
- 14 Total of all the money received for this restricted fund during the audit period. This money is restricted and will only be paid out for the intention in which it was collected.
- 15 Total of all the money received for the Relief Fund during the audit period.
- 16 Sum of lines 12 through 15.
- 17 Total of all the money received for the "Other" Fund listed during the audit period.
- 18 Total of all the money received for the "Other" Fund listed during the audit period.
- 19 Total of all the money received for the "Other" Fund listed during the audit period.
- 20 Sum of lines 16 through 19.
- 21 Total of all money received for Savings. This would include any interest earned.
- 22 Sum of lines 20 through 21. All money deposited during the audit period.

Veterans of Foreign Wars Auxiliary Sample Auxiliary Audit Form Instructions

<u>Line</u>	<u>Description</u>
23	Total of all money disbursed from the General Fund during the audit period.
24	Total of all money disbursed for Department & National dues during the audit period. Should equal amount sent to Department Treasurer.
25	Total of all money disbursed for restricted fund during the audit period.
26	Total of all money disbursed from the Relief Fund during the audit period.
27	Sum of lines 23 through 26.
28	Total of all money disbursed from the "Other" Fund listed during the audit period.
29	Total of all money disbursed from the "Other" Fund listed during the audit period.
30	Total of all money disbursed from the "Other" Fund listed during the audit period.
31	Sum of lines 27 through 30.
32	Total of all money disbursed from Savings during the audit period.
33	Sum of lines 30 through 31. All money disbursed during the audit period (checks written).
34	Sum of line 1 plus line 12 minus line 23.
35	Sum of line 2 plus line 13 minus line 24.
36	Sum of line 3 plus line 14 minus line 25.
37	Sum of line 4 plus line 15 minus line 26.
38	Sum of line 5 plus line 16 minus line 27. Should equal the sum of lines 34 through 37.
39	Sum of line 6 plus line 17 minus line 28.
40	Sum of line 7 plus line 18 minus line 29.
41	Sum of line 8 plus line 19 minus line 30.
42	Sum of line 9 plus line 20 minus line 31. Should equal the sum of lines 38 through 41.
43	Sum of line 10 plus line 21 minus line 32.
44	Sum of line 11 plus line 22 minus line 33. Should equal the sum of lines 42 through 43. Ending cash balance of all funds.
45	Ending bank balance as shown on the bank statement at the end of the audit period.
46	Check number of each outstanding check that had not cleared the bank as of the last bank statement during the audit period.
47	Amount of each outstanding check that had not cleared the bank as of the last bank statement during the audit period.
48	Sum of all outstanding checks that had not cleared the bank as of the last bank statement during the audit period.
49	Sum of line 45 minus line 48.
50	Date of each outstanding deposit that had not cleared the bank as of the last bank statement during the audit period.
51	Amount of each outstanding deposit that had not cleared the bank as of the last bank statement during the audit period.
52	Sum of all outstanding deposits that had not cleared the bank as of the last bank statement during the audit period.
53	Sum of line 49 plus line 52.
54	Date the audit was conducted. (i.e. 04/15/20XX)
55	Signatures and date of signatures of elected Trustees.

Districts

The District is chartered by National and has legislative and limited taxing power. Its purpose is to promote schools of instruction and to insure functioning Auxiliaries within the confines of the District through instruction and Official Visits.

The District President is a Department Officer and a member of the Department Council of Administration.

The District President would represent the Auxiliaries of their District at VFW activities and as a part of the Department Council of Administration.

County Councils were disbanded by the VFW in 2022.

National Programs

The National Programs are determined by each year's National President. For details on the Programs, goals and awards, please see the current National Program Book available on the website.

Duties of All Chairmen

1. To promote the best interests of the Auxiliary in a manner to reflect credit on the Auxiliary and bring honor to the organization.
2. To call committee meetings at regular intervals and plan activities to advance the Auxiliary Program.
3. To present to the Auxiliary all information pertinent to the Chairmanship and see that action is taken when necessary. (See the current National Program Book, Department Publications and the Department Chairmen's promotional material.)
4. Keep a notebook and file pertaining to the chairmanship, together with a copy of each meeting's report. It is the duty of the Auxiliary Chairman to mail or email a year-end report of all work accomplished to the corresponding Department Chairman.
5. To secure the interest and cooperation of as many members as possible and the public in the cause, which your Chairmanship supports.
6. To make written financial reports (with bills attached) of any fundraising functions.
7. To resign promptly if and when absolutely impossible to function, so that the Program of the Auxiliary may not be delayed.

Veterans Affairs Voluntary Service Program (VAVS)

1. A National VAVS Advisory Committee has been established at the VA Central Office in Washington, D.C., to advise in the planning, integration, and coordination of VA Voluntary Service. Veterans of Foreign Wars of the United States Auxiliary is one of the member organizations of this committee and is represented by the National VAVS Representative and Deputy Representative(s) appointed by the National President.
2. The VAVS Advisory Committee for each local VA Hospital is composed of one (1) local representative and one (1) or more (not to exceed three (3)) deputy representatives from each of the member organizations. Our VAVS Representatives and Deputy Representatives are recommended by the Department President to the National VAVS Representative who certifies them to the VA Facility Director, Attn: Voluntary Service Program Manager.
 - A change may be made between certifications when it is in the best interest of the VAVS program.
 - When a change in representation is necessary for any reason, National Headquarters must be notified immediately.
 - Careful consideration should be given to the selection of the VAVS Representatives and Deputies.
 - The National Headquarters Office of the Auxiliary shall send official certification to: VA Facility Director, Attn: Voluntary Service Program Manager.
3. An Associate VAVS Representative may be appointed where Auxiliary members from a neighboring state participate in the VAVS Program. The Department President of the neighboring state appoints one (1) Associate Representative to assist by developing and coordinating the Auxiliary part of the program in their state. Associate Representatives are certified in the same manner as a Representative and serves on the VAVS Committee except for voting privileges, which may be delegated in absence of the Representative. The Associate Representative must work through the VAVS Representative at the VA Hospital in which they serve.
4. An Honorary VAVS Representative is an individual who
 - Has given ten (10) or more years of service as a VAVS Representative or ten (10) or more years of combined service as Deputy Representative and VAVS Representative.
 - This can apply to Deputy Representatives and Associate Representatives.

- At the time of recommendation, the applicant must be the certified Representative, Deputy Representative, or Associate Representative.
 - They must be designated as Honorary Representative by the Department President and certified by the National Certifying Official.
 - They maintain this status for life, but can't be a regular representative again.
5. Hospital Service Pins designating the number of hours a volunteer has devoted to hospital work will be awarded to members meeting eligibility requirements.
 - An Auxiliary member in good standing who has worked a minimum of 150 hours under Auxiliary sponsorship in any hospital is eligible to receive a pin as a gift of the National Organization.
 - Pins are available for volunteers who have served 150, 300, 500, 1,000, 1,500, 2,000, 2,500, 3,000 and 4,000 hours. The 5,000 hour pin is triangular. One (1) pearl is added for each additional 1,000 hours. A bar guard signifying 10,000 hours may be attached to this pin, and thereafter. Bar guards are available for each additional 1,000 hours.
 - Only Auxiliary members are entitled to receive and wear the Auxiliary Hospital Service Pins.
 - The sponsored hospital volunteer (including student volunteer), who works a minimum of 100 hours under Auxiliary sponsorship in any hospital, is eligible to receive a special pin from National Headquarters. Only one (1) pin may be ordered for each sponsored volunteer.
 6. The National Organization has a “Hospital Program Guide” and a “VAVS Participation Guide,” which is available in Member Resources. Please refer to these guides for full details and the most up-to-date information on our participation in VAVS.

Guests and Visitors at a Meeting, Clarification Of

There are several opportunities to have guests at a meeting.

1. Potential Members

- *You can invite potential members to a meeting so they can experience a meeting to see if they would like to join. This should be a one time only invitation. (Page 5 in the Ritual under Members' Instructions addresses this.)*

2. VFW

- *You can invite your Commander to a meeting. This should be one time a year, not monthly. You can invite them back if there is something special they would like to share. They can come either before your meeting or after presentation of bills* or even just for the Good of the Order.*

3. Other Guests

- *You can invite guests to a meeting to present them with an award, like the Voice of Democracy students or a local business owner.*

****The Ritual states: Introduction of Guests - D (Any non-Auxiliary member guests shall not be allowed to enter the room until the Treasurer's Report and Presentation of Bills has concluded.)***

There are several opportunities to have visitors at a meeting.

1. Potential Visitors - Bylaws - Section 112

- *An Official Representative of your Department (Escorted Guests, #2 Order of Business).*
- *An Official Representative of your Department (Not Escorted Guests, #8 Order of Business).*
- *An Auxiliary member passing through the area of your meeting at the time of your meeting.*
- *Members-at-Large*
- *Candidates for District, Department and/or National Offices.*
- *See Section 909 - Children and Caregivers.*

We show our dues cards for a reason. We are a member-based organization. Only members should be allowed in our meeting with very few exceptions. Open meetings are allowed for Installation of Officers and/or Program Presentations. No motions or voting should occur at an open meeting. If you are joining a meeting via electronic means, all efforts should be put forth to not include any non-members within earshot.

To Help Clarify the Official Look

1. Section 1001 explains the Official Look

- *The look may be worn open over any color top or a black dress. The look may be worn tucked in.*
- *You may wear it with a jacket or sweater, preferably black.*
- *The collar pins should be worn flat on the collar, not on an angle. VFW over the heart.*

- *The official membership pin should be worn on the left, above the emblem.*
- *The name tag should be worn on the side without the emblem.*
- *If you wear an American Flag pin, it should be highest on the shirt (not including collar pins), over your heart.*
- *Caps are optional. Caps may be worn with pins attached.*
- *Caps are to be removed for prayers, if the Chaplain removes their cap or is not wearing one.*
- *When removing the cap, place the cap over the heart with the emblem facing out, fingers just inside the cap.*

Diagrams



NOTES

NOTES

NOTES

RITUAL

VETERANS OF FOREIGN WARS
OF THE UNITED STATES

AUXILIARY



As Amended
July 24, 2020

Effective Date
August 23, 2023

Published at
NATIONAL HEADQUARTERS
KANSAS CITY, MISSOURI 64111

RITUAL

VETERANS OF FOREIGN WARS OF THE UNITED STATES

AUXILIARY



As Amended
July 24, 2020

Effective Date
August 23, 2023

Based upon Sec. 1202-Amendments-Ritual, adopted amendments or alterations to the Ritual will be made every five (5) years. The next Ritual revision will be in July 2025 at the 112th National Convention.

TABLE OF CONTENTS

General Instructions.....	1
Auxiliary/District Meetings.....	8
Traditional Meeting	
Traditional Meeting with Floor Work.....	9
Traditional Meeting Without Floor Work.....	23
Contemporary Meeting.....	32
Roundtable Meeting.....	41
Nominations and Elections of Officers.....	42
Installation of Officers.....	49
Department Meetings and Officer Installations.....	56
Suggested Agenda for a Council of Administration Meeting.....	57
Suggested Department Convention Order of Business.....	58
Department Convention.....	59
Nominations and Elections of Officers.....	60
Installation of Department Officers.....	66
Installation of National Officers.....	71
Special Ceremonies.....	77
Member Initiation.....	78
Member Obligation.....	80
Auxiliary Institution.....	84
Auxiliary Obligation.....	84
Districts.....	86
Form for Instituting Departments.....	87
Contemporary Memorial Service.....	90
Draping of the Charter.....	90
Memorial Service.....	92
Draping the Altar.....	93
Traditional Memorial Service.....	97
Draping of the Charter.....	97
Memorial Service.....	99
Draping the Altar.....	100
Dedication of the Colors.....	105
Honoring Gold Star Parents.....	108
Services for Deceased Members.....	109
Memorial Day Service.....	111
Memorial Services for National and Department Conventions and for Posts of the Veterans of Foreign Wars of the United States and Their Auxiliaries.....	112
Form of Services to be used on Memorial Day at the Graves, Monuments or Tablet of Our Departed Brothers, Sisters or Comrades.....	113
Instructions for Placing Grave Marker Other Than at Time of Burial.....	114
Floor Plans.....	115

GENERAL INSTRUCTIONS

GENERAL INSTRUCTIONS

Raps of the Gavel

One (1) rap of gavel—Attention

Two (2) raps of gavel—Rise

Three (3) raps of gavel—Be Seated

Salutes

When salute is used, Heart Salute or Military Salute (veterans) shall be used at all times.

1. ATTENTION

Attention in the Veterans of Foreign Wars of the United States Auxiliary means hands at side, head up with eyes looking straight ahead.

2. HEART SALUTE

- a. Members of the Auxiliary shall rise and salute the Flag by placing the palm of the right hand flat over the heart, or Military Salute (veterans) when the Flag passes by in parade. (See Diagram 1, page 6)
- b. During Auxiliary meetings, the Heart Salute or Military Salute (veterans) shall be used at all times where salute is used.
- c. When the Flag **IS** displayed, and the National Anthem **IS** played and/or sung, all present should face the Flag and salute.
- d. When the Flag **IS NOT** displayed and the National Anthem is played and/or sung, all present should face the music and salute.
- e. When Taps is played, all present shall stand, face the Flag and salute – Heart Salute or Military Salute.
- f. After the Flag Bearer places the U.S. Flag, they should salute. When they turn back to the members, all salutes should be dropped.

3. PARADE REST

The left foot is moved slightly to the side while bringing the arms to the small of the back. Place the left thumb in the palm of the right hand. The head is bowed slightly during the prayer. (See Diagram 3, page 6)

4. ROOM SETUP *(At the discretion of the Auxiliary)*

- Auxiliary room should be set up and Officers positioned per Floor Plan 1. In the center of the room, there should be an Altar upon which is placed an Altar cloth. The Bible SHALL be placed on the Altar in the CENTER of the Altar cloth.
- There should be a table or podium with a gavel thereon for the use of the presiding Officer.
- Each Auxiliary should have a Patriotic Instructor's Flag, four (4) Color Bearers' Flags, Flag and Banner and flag stands for each. (Color Bearers' Flags should be 2' x 3' and Patriotic Instructor Flag should be 3' x 5'.)
- The Conductor shall prepare the Auxiliary room for the meetings; they shall see that the charter, gavel, Altar cloth, Bible and flag stands are placed properly before the meetings are called to order. The Patriotic Instructor's Flag, four (4) Color Bearers' Flags, Flag Bearer's Flag and Banner Bearer's banner should be placed conveniently in the anteroom.
- POW/MIA flag may be posted prior to the meeting. If posted, it is placed to the inside of the banner. (See Floor Plans)
- According to Public Law 94-344 dated July 7, 1976, the American Flag shall be placed at the right of the presiding Officer at all times.
- The Patriotic Instructor's Flag shall be placed on the floor level at all times and to the RIGHT of the presiding Officer, between the President's and Secretary's stations.

5. OFFICERS' INSTRUCTIONS

- When standing or marching, Officers should assume a military bearing, hands hanging free and empty at the sides; they should proceed in straight lines and turn square corners.
- All Officers having any part in the floor work ceremonies should be furnished a Ritual and they should make themselves familiar with all the details thereof. They should, if possible, commit to memory their respective parts and duties.
- The President stands while presiding except when another individual is at the podium or giving a report from the floor.
- The Musician should stand during the Pledge of Allegiance, prayer and obligation.
- The Patriotic Instructor shall see that the pledge to the Flag is given properly and that due respect to the Flag is observed at all times by the members.
- During floor work ceremonies, the Flags shall be borne at attention. When placing Flags, eagles shall face the assembly.
- The Color Bearers' Flags shall be held at attention with the right hand above on the flagstaff, left hand on a level with the right elbow with left arm across the waist. (See Diagram 2, page 6)
- The Color Bearers carrying the Flags do not sing or recite the pledge to the Flag. They always place the Flags in stands before sitting down. Stands must be placed at the right of the Color Bearer's chairs. (See Floor Plan 1) While seated, Color Bearers shall sit at attention with feet on the floor.
- When Officers (including Color Bearers, Flag Bearer and Banner Bearer) vacate their stations, but remain in the room, the chair does not have to be filled by another member.
- The members will remain seated or stationary while the Chaplain opens and closes the Bible, provided the Colors are not at the Altar.

- The Guard should never leave their position at the door while the Auxiliary is in session, unless relieved by someone appointed by the presiding Officer to fill their station.

6. ESCORTING GUESTS

When escorting guests, into or leaving the meeting room, the Conductor and Assistant Conductor will escort only one (1) person each. The Conductor will escort the highest ranking person followed by other guests with the Assistant Conductor escorting the one with the lowest ranking person being last.

1. After the escort of the guests, the Chaplain will step into the line as the Colors pass their station and proceed to the Altar and close the Bible.
2. Chaplain will meet the Colors at Senior Vice-President's station to open the Bible after Guests have been escorted from the room.

7. MEMORIAL SERVICES FOR DECEASED MEMBERS

- An Auxiliary may offer to hold Memorial Services for a deceased member by contacting family without waiting for a request from the family. Any part of the service that may conflict with any religious belief may be omitted or changed.
- Officers should not read aloud the notes in the lightface type. (*See page 110 for Memorial Services for Deceased Members.*)

8. MEMBERS' INSTRUCTIONS

- On entering the meeting room after the Auxiliary is in session, members will show their membership card to the Guard.
- Eligible individuals may attend one (1) meeting at the invitation of a member in good standing with the President's permission.
- Those eligible individuals shall be allowed to enter after the Treasurer's Report and Presentation of Bills.

Diagram #1

Heart Salute



Military Salute
(veterans)



Diagram #2

Flag shall be held as
straight as possible.



Diagram #3

Parade Rest



Handling a Simple Motion

(Does not include steps for amendments.
See *Robert's Rules of Order, Newly Revised.*)

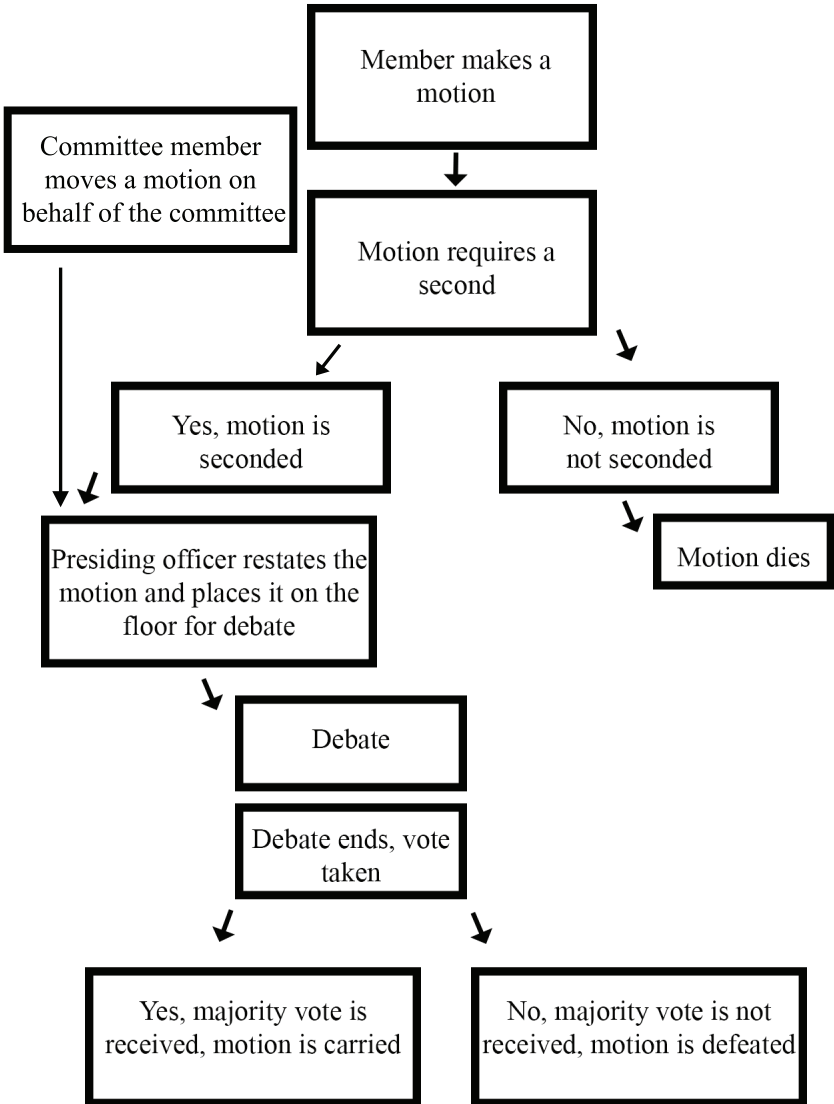

AUXILIARY/DISTRICT MEETINGS

TRADITIONAL MEETING

(With Floor Work)

AUXILIARY/DISTRICT ORDER OF BUSINESS

1. Opening Ceremonies
2. Escort and Introduction of National and/or Department Officers (*See page 16 for Escort*)
3. Roll Call of Auxiliaries (*District only*)
4. Reading and Referring of Applications for Membership
 - a. Report of Investigating Committee
 - b. Voting on Candidates
 - c. Initiation
5. Presentation of Minutes and Official and Other Communications
6. Treasurer's Report
7. Presentation of Bills
8. Introduction of Guests, who are Not Escorted
9. Reports of Committees, Standing and Special
10. Unfinished Business
11. New Business
12. Report of Trustees and Action Thereon
13. Suggestions for the Good of the Order
14. Closing Ceremonies

1. AUXILIARY/DISTRICT OPENING CEREMONIES

If an Officer is unable to be present, they should notify the President. The President shall then appoint a member to fill their station before the meeting starts.

President gives one (1) rap of gavel.

President: **Please rise for the posting of the POW/MIA flag.** (Optional). **This Auxiliary meeting is called to order. The Officers will take their respective stations. All persons not members of the Veterans of Foreign Wars Auxiliary will kindly retire.**

President: **Mister/Madam Guard, close the doors and allow no one to enter until the opening services have been concluded.**

Guard: **Mister/Madam President, your orders have been obeyed.**

President: **Mister/Madam Conductor (and Assistant Conductor, satisfy yourself that all present are entitled to remain.**

Two (2) raps.

The Conductor will examine each member's dues card, assisted as directed by the President. Those found in possession of the official Auxiliary membership dues card for the current calendar year may be seated. Conductor then advances to the Altar. This may be omitted if the Guard had already checked dues cards at the door.

Conductor (and Assistant Conductor: **Mister/Madam President, I find all, except those standing, in possession of the official membership dues card for the current calendar year.**

If Assistant Conductor assists, Conductor checks those to the President's right; Assistant Conductor, those to the President's left.

President instructs the Treasurer to determine the status of members standing. Those who have not paid their current dues will be required to pay said dues or leave the meeting room.

President: **Mister/Madam Secretary, you will call the roll of the Officers.**

At the command of the President to call the roll, both Secretary and Conductor rise. The Secretary calls the title and name of each Officer, who will rise and remain standing until all have been called. The Conductor responds "present" or "absent." President announces pro tem Officers.

President: **Color Bearers, secure and present the Colors.**

(See Floor Plan 2)

When the Color Bearers are directed to secure and present the Colors, the Conductor, Patriotic Instructor, Flag and Banner Bearers and four Color Bearers will rise together and proceed from their stations to the rear of the Altar, keeping in line with each other. The Patriotic Instructor waits until the Color Bearers, Conductor, Flag Bearer and Banner Bearer are in line with their station; then proceeds with the other five (5) Officers, towards the Senior Vice-President's station.

After Color Bearers 3 and 4 rise, 3 takes a step to right, and 4 a step to the left, and remain standing in that position until the other Officers are in line with them, facing the President. Color Bearers 1 and 2 pause in front of Color Bearers' 3 and 4 chairs, about face, facing the President. All advance to the rear of the Altar in a straight line.

(See Floor Plan 3)

Conductor: **About face, march.**

All retire—double file—to the anteroom, led by Color Bearers 3 and 4, then Conductor and Patriotic Instructor, Flag Bearer and Banner Bearer—followed by Color Bearers 1 and 2. Upon wishing to enter, the Conductor will summon the Guard who announces:

Guard: **Mister/Madam President, the Colors.**

Two (2) raps.

President: **You will admit them. Salute!**

Members will hold this salute until the Flags are posted.

(See Floor Plan 4)

Upon entering with the Colors, Color Bearers 1 and 2 lead, double file, followed by the Conductor and Patriotic Instructor, Flag Bearer and Banner Bearer, and Color Bearers 3 and 4. All march toward the President's station, passing the Chaplain's station on the right. When in front of the President's station, the Conductor-gives command:

Conductor: Two's (2), right face!

The Patriotic Instructor places the Flag with the eagle facing the assembly, steps back one (1) pace, salutes the Flag using Heart Salute or Military Salute (veterans), does an about face and takes their place in line of Officers beside the Conductor and faces the President.

When the Patriotic Instructor is back in position with line of Officers, the Flag Bearer and Banner Bearer place the Flag and Banner in the stands at the same time. After the Flag Bearer places Flag in stand, they step back one (1) pace, salutes the Flag, using Heart Salute or Military Salute (veterans). Both about face and proceed directly to their stations. After placement of Flag and Banner, the President gives command:

President: Attention!

Conductor: Two's (2) left, march.

Conductor, Color Bearers and Patriotic Instructor march to position in front of Senior Vice-President's station and proceed to the Altar.

*The Chaplain leaves their station as the Color Bearers pass the station of the Junior Vice-President, meets the Conductor and Patriotic Instructor at the Senior Vice-President's station and proceeds to the Altar between the Conductor and Patriotic Instructor. Color Bearers 1 and 2 separate, left and right. The Conductor takes a position to the left of the Chaplain and the Patriotic Instructor takes a position to the right of the Chaplain. Color Bearers 3 and 4 then step to a position beside Color Bearers 1 and 2. All stand in a straight line facing the President. The Chaplain takes one (1) step forward, **reverently** opens the Bible and places it in the center of the Altar.*

President: **The Chaplain will now offer the opening prayer.**

Conductor: **Color Bearers, Altar position.**

When the Chaplain is directed to offer the opening prayer, Color Bearers proceed to each side of the Altar, led by Color Bearers 3 and 4, followed by Color Bearers 1 and 2 and turn toward the Altar, holding Flags upright, not obstructing the view of the Chaplain, remaining in that position during the prayer. Chaplain assumes position of Parade Rest.

President: **Parade Rest.**

OPENING PRAYER

Chaplain: **Dear God, we thank Thee for the great privilege Thou has bestowed upon us to again allow us to assemble in this meeting. We pray and beg of Thee to keep us, Thy servants, from temptation, to keep us in health and strengthen us in spirit so that we may perform our duties to our Brothers, Sisters and Comrades. Bless we ask Thee, the families of all departed Comrades and help us to realize our duties toward them and toward the Veterans of Foreign Wars. Amen.**

All: **Amen.**

The Chaplain takes one (1) step back into line with Officers.

President: **Attention!**

Conductor: **Color Bearers, right and left face, forward march!**

Color Bearers proceed to the rear of the Altar in line with Conductor. Color Bearers 1 and 3 turn right; Color Bearers 2 and 4 turn left; Color Bearers 1 and 3, left face and Color Bearers 2 and 4, right face. All Color Bearers will be facing the Senior Vice-President's station.

Conductor: **About face.**

This brings Color Bearers facing President's station. All remain standing in that position until directed to take their stations.

Patriotic Instructor: **Let us be ever mindful of our duties as members of the Veterans of Foreign Wars of the United States Auxiliary, to see that our Flag is never desecrated and to teach the people of our land what this means and to see that all are instructed in the pledge to the Flag.**

President: **You will salute and give pledge to the Flag.**
Heart Salute or Military Salute (veterans). All rise and face Patriotic Instructor's Flag.

I PLEDGE ALLEGIANCE to the Flag of the United States of America and to the REPUBLIC for which it stands, (pause) one nation under GOD (pause) INDIVISIBLE (pause) with LIBERTY and JUSTICE FOR ALL. Emphasis is given to the words in capital letters.

President: **We will now sing the National Anthem, Salute!**

Heart Salute or Military Salute (veterans) is used any time the National Anthem is played or sung.

**Oh, say, can you see by the dawn's early light,
What so proudly we hailed at the twilight's last gleaming?
Whose broad stripes and bright stars thru' the perilous fight,
O're the ramparts we watch'd were so gallantly streaming;
And the rockets' red glare, the bombs bursting in air,
Gave proof thru' the night that our Flag was still there.
Oh, say, does that star spangled banner yet wave
O're the land of the free, and the home of the brave?**

President: **Attention!**

Brothers and Sisters, by dispensation of Divine

Providence, we have been permitted to assemble again in this room and I trust that the business transacted here will be for our mutual pleasure and benefit. Remember the duty we owe one another and if we thus carry out daily the lessons and principles taught in this Auxiliary room, our country will be better that we have existed. Let all our actions be for the greater glory of our cause.

President: Officers, take your stations.

Conductor: Color Bearers, right and left face, march!

(See Floor Plan 5)

The Conductor, Chaplain and Patriotic Instructor about face, Color Bearers 1 and 3 left face, Color Bearers 2 and 4 right face and all moving at the same time. Color Bearers 1 and 2 march to a point even with their chairs and make a sharp turn toward their stations; Color Bearers 3 and 4 march to a point even with their chairs and make a sharp turn toward their stations; all remain standing in front of and facing their chairs. The Chaplain and Patriotic Instructor leave the Altar at the same time with the Conductor proceeding toward the Senior Vice-President's station, where the Patriotic Instructor takes one (1) additional step past the Chaplain, placing them on the Chaplain's right. They left turn and after passing beyond Color Bearer 4, they left turn and proceed to their stations. When the Conductor reaches a point beyond Color Bearer 3's chair they make a right turn and proceed toward their station. When they are even with the Altar, they give the command.

Conductor: Color Bearers, about face!

The Color Bearers place Flags immediately.

Three (3) raps.

President: I now declare this Auxiliary meeting open for the transaction of such business as may properly come before it. Mister/Madam Guard, admit any member who may be in waiting.

2. ESCORT AND INTRODUCTION OF NATIONAL AND/OR DEPARTMENT OFFICERS

- A. Escort through Aisle of Honor Commander-in-Chief or National President, alone, with Bible open.
- B. Escort to the President’s station with the Colors.
- C. The following to be escorted into meeting at the **same time** and presented in order as listed:
 - National Elected Officers
 - Past National Presidents
 - National District Council Members and National Appointed Officers
 - National Ambassadors and National Chairmen

Department President is to be escorted **first and alone** when making Official Visit.

Past Department Presidents, all visiting Department Presidents and Department Officers.

District President is to be escorted **first and alone** when making Official Visit as a representative of the Department President.

All National Officers and Past National Presidents are to be seated to the immediate right of the presiding Officer.

At the time of the Official Visit of Department President, they shall be seated to the immediate right of the presiding Officer. Their official representative shall be accorded the same courtesies.

All Department Officers are to be seated to the immediate left of the presiding Officer.

3. ROLL CALL OF AUXILIARIES *(District/Council Only)*

Items 4, 4a, 4b and 4c are for Auxiliary Order of Business only.

4. READING AND REFERRING OF APPLICATIONS FOR MEMBERSHIP

President: Mister/Madam Secretary, do we have any applications for membership?

Secretary: Mister/Madam President, we have (or don't have).

Secretary reads names of applicants.

4a. REPORT OF INVESTIGATING COMMITTEE

President: We will now have the report of the investigating committee.

The committee will recommend election or rejection in accordance with Section 102 of the National Bylaws.

4b. VOTING ON CANDIDATES

Follow the procedure set forth in Section 103 of the National Bylaws.

President: If there is no objection, we will have a voice vote to accept this candidate.

President: Mister/Madam Secretary, you will notify the applicant (or applicants) to present themselves for initiation at the proper time.

4c. INITIATION *(See page 78 for Member Initiation.)*

5. PRESENTATION OF MINUTES AND OFFICIAL AND OTHER COMMUNICATIONS *(Manner of presentation is by the vote of the Auxiliary.)*

President: We will now have the presentation of the minutes of the previous meeting.

Are there any corrections?

If none —The minutes will stand approved as read.

If corrected—The minutes will stand approved as corrected.

President: We will now have the presentation of official and other communications by the Secretary.

6. TREASURER'S REPORT (*Manner of presentation is by the vote of the Auxiliary.*)

President: Mister/Madam Treasurer, please present the Treasurer's Report.

The Treasurer gives the report of the previous meeting.

President: Is there any discussion pertaining to the Treasurer's Report? If not, the Treasurer's Report will be filed subject to audit.

7. PRESENTATION OF BILLS

Bills to be read by Secretary, then Conductor takes bills to Trustees for approval.

8. INTRODUCTION OF GUESTS, WHO ARE NOT ESCORTED

- A. Department Chairman of standing committees to be recognized from the floor.
- B. Other member guests to be recognized from the floor
- C. Introduce non-member guests. (*Any non-Auxiliary member guest shall not be allowed to enter the room until the Treasurer's Report and Presentation of Bills has concluded.*)

9. REPORTS OF COMMITTEES, STANDING AND SPECIAL

President: Reports of Committees, standing and special, is the next business in order.

Call on all committees, including Program Chairmen.

The Audit Report is called for after each quarterly audit and is the ONLY REPORT accepted by motion.

10. UNFINISHED BUSINESS

President: Next we will have Unfinished Business.

The Secretary should be prepared to remind the President of any unfinished business.

11. NEW BUSINESS

President: The next order of Business is New Business.

Under New Business—Draping of Charter, Election of Officers, etc.

Nominations and Elections of Officers are outlined on pages 60 to 65. Voting is clarified in Section 805 of the National Bylaws.

12. REPORT OF TRUSTEES

President: We will now have the Report of Trustees.
(Motion is required for payment of bills.)

13. SUGGESTIONS FOR THE GOOD OF THE ORDER

President: Are there any Suggestions for the Good of the Organization?

Instructions by Patriotic Instructor; new members and guests should be invited to speak at this time.

14. CLOSING CEREMONIES

President: Is there anything further to come before this meeting? (Pause)

If not, this concludes our business. Officers, present

yourselves at the Altar for the closing ceremonies.

Two (2) raps.

When directed to present themselves at the Altar, only the Color Bearers with the Colors, Conductor and Chaplain advance to the Altar.

Conductor: **Color Bearers, Altar position.**

The Chaplain pauses until Color Bearers have assumed Altar position as for opening prayer.

President: **Parade rest!**

CLOSING PRAYER

Chaplain: **Heavenly Father, the hour has now come when we must separate; commit us to Thy tender mercy and care. We thank Thee for Thy many blessings and beg of Thee to preserve our Auxiliary. Help us to make it one of faithfulness, charity and true patriotism. May the grace, mercy, peace and blessing of God the Father be with each and every one of us. Amen.**

All: **Amen.**

President: **Attention!**

Conductor: **Color Bearers, right and left face, forward march!**

Color Bearers proceed to the rear of the Altar in line with Conductress. Color Bearers 1 and 3 turn right; Color Bearers 2 and 4 turn left; Color Bearers 1 and 3, left face and Color Bearers 2 and 4, right face—All Color Bearers will be facing the Senior Vice-President's station.

Conductor: **About face.**

The Chaplain closes the Bible.

The Chaplain takes one (1) step back into line with Officers.

President: We are about to leave this Auxiliary room. Let us endeavor to so regulate our conduct that it will bring honor to our organization. I now declare this meeting closed with the retiring of the Colors. The next meeting will be _____.

The date of the next meeting will be the cue for the Conductor to give their command.

Conductor: About face, march.

(See Floor Plan 6)

Color Bearers 3 and 4 lead, followed by Conductor and Chaplain; then Color Bearers 1 and 2 double file, march toward the Senior Vice-President's station where the Chaplain takes one (1) additional step past the Conductor, putting them on the right side of the Conductor. All turn left and proceed toward the Chaplain's station, where they resume their position. The Patriotic Instructor joins the Conductor and all march to a position in front of the President's station. (The POW/MIA flag may remain in the room.)

Conductor: Two's (2), right face!

The Patriotic Instructor steps forward, salutes the Flag. As they salute, President gives command:

President: Salute!

The Patriotic Instructor takes the Flag from the stand, does an about face and proceeds to position at the right of the Conductor, facing the President. When the Patriotic Instructor is in position, the Flag Bearer and Banner Bearer step forward from their stations. Flag Bearer salutes the Flag. The Flag Bearer and Banner Bearer secure the Flag and Banner from the stands at the same time. The Flag Bearer and Banner Bearer should turn and face each other; then, right and left face and advance to center of line towards each other, hesitating in front of Patriotic Instructor and Color Bearer 2. Flag Bearer steps in line facing Color Bearer 2 and Banner Bearer steps in line behind the Flag Bearer facing the Patriotic Instructor. Immediately, Flag Bearer does a left face

and Banner Bearer does a right face, all facing the President's station.

Conductor: **Two's (2) left, march.**

All return to double file and march past the Junior Vice-President's station to the door if on right side of room; if door is on left side of room, they march in front of Senior Vice-President's station and out of room—without further orders.

The members shall hold the salute until the order is given to return to attention.

President: **Attention!**

As soon as the Colors are off the floor, the President will give one (1) rap to indicate adjournment.

TRADITIONAL MEETING

(Without Floor Work)

AUXILIARY/DISTRICT ORDER OF BUSINESS

1. Opening Ceremonies
2. Escort and Introduction of National and/or Department Officers (*See page 16 for Escort*)
3. Roll Call of Auxiliaries (*District only*)
4. Reading and Referring of Applications for Membership
 - a. Report of Investigating Committee
 - b. Voting on Candidates
 - c. Initiation
5. Presentation of Minutes and Official and Other Communications
6. Treasurer's Report
7. Presentation of Bills
8. Introduction of Guests, who are Not Escorted
9. Reports of Committees, Standing and Special
10. Unfinished Business
11. New Business
12. Report of Trustees and Action Thereon
13. Suggestions for the Good of the Order
14. Closing Ceremonies

1. AUXILIARY/DISTRICT OPENING CEREMONIES

If an Officer is unable to be present, they should notify the President. The President shall then appoint a member to fill their station before the meeting starts.

President gives one (1) rap of gavel.

President: **This Auxiliary meeting is called to order. The Officers will take their respective stations. All persons not members of the Veterans of Foreign Wars Auxiliary will kindly retire.**

President: **Mister/Madam Guard, close the doors and allow no one to enter until the opening services have been concluded.**

Guard: **Mister/Madam President, your orders have been obeyed.**

President: **Mister/Madam Conductor (and Assistant Conductor, satisfy yourself that all present are entitled to remain.**

Two (2) raps.

The Conductor will examine each member's dues card, assisted as directed by the President. Those found in possession of the official Auxiliary membership dues card for the current calendar year may be seated. Conductor then advances to the Altar. This may be omitted if the Guard had already checked dues cards at the door.

Conductor (and Assistant Conductor: **Mister/Madam President, I find all, except those standing, in possession of the official membership dues card for the current calendar year.**

If Assistant Conductor assists, Conductor checks those to the President's right; Assistant Conductor, those to the President's left.

President instructs the Treasurer to determine the status of members standing. Those who have not paid their current dues will be required to pay said dues or leave the meeting room.

President: **Mister/Madam Secretary, you will call the roll of the Officers.**

At the command of the President to call the roll, both Secretary and Conductor rise. The Secretary calls the title and name of each Officer, who will rise and remain standing until all have been called. The Conductor responds "present" or "absent." President announces pro tem Officers.

President: **Officers, present yourselves at the Altar for the Opening Services.**

Two (2) raps.

At the command of the President, the Conductor, Chaplain and Patriotic Instructor rise and advance to rear of Altar. Once in a straight line, the Chaplain takes one step forward, reverently opens the Bible and places it in the center of the Altar.

President: **The Chaplain will now offer the opening prayer.**

President: **Parade Rest.**

OPENING PRAYER

Chaplain: **Dear God, we thank Thee for the great privilege Thou has bestowed upon us to again allow us to assemble in this meeting. We pray and beg of Thee to keep us, Thy servants, from temptation, to keep us in health and strengthen us in spirit so that we may perform our duties to our Brothers, Sisters and Comrades. Bless we ask Thee, the families of all departed Comrades and help us to realize our duties toward them and toward the Veterans of Foreign Wars. Amen.**

All: **Amen.**

The Chaplain takes one (1) step back into line with Officers.

President: **Attention!**

Patriotic Instructor: **Let us be ever mindful of our duties as members of the Veterans of Foreign Wars of the United States Auxiliary, to see that our Flag is never desecrated and to teach the people of our land what this means and to see that all are instructed in the pledge to the Flag.**

President: **You will salute and give pledge to the Flag.**
*Heart Salute or Military Salute (veterans). All rise and face
Patriotic Instructor's Flag.*

I PLEDGE ALLEGIANCE to the Flag of the United States of America and to the REPUBLIC for which it stands, (pause) one nation under GOD (pause) INDIVISIBLE (pause) with LIBERTY and JUSTICE FOR ALL. *Emphasis is given to the words in capital letters.*

President: **We will now sing the National Anthem, Salute!**

Heart Salute or Military Salute (veterans) is used any time the National Anthem is played or sung.

**Oh, say, can you see by the dawn's early light,
What so proudly we hailed at the twilight's last gleaming?
Whose broad stripes and bright stars thru' the perilous fight,
O're the ramparts we watch'd were so gallantly streaming;
And the rockets' red glare, the bombs bursting in air,
Gave proof thru' the night that our Flag was still there.
Oh, say, does that star spangled banner yet wave
O're the land of the free, and the home of the brave?**

President: **Attention!**

Brothers and Sisters, by dispensation of Divine Providence, we have been permitted to assemble again in this room and I trust that the business transacted here will be for our mutual pleasure and benefit. Remember the duty we owe one another and if we thus carry out daily the lessons and principles taught in this Auxiliary room, our country will be better that we have existed. Let all our actions be for the greater glory of our cause.

President: **Officers, take your stations.**

Three (3) raps.

President: **I now declare this Auxiliary meeting open for the transaction of such business as may properly come before it. Mister/Madam Guard, admit any member who may be in waiting.**

2. ESCORT AND INTRODUCTION OF NATIONAL AND/OR DEPARTMENT OFFICERS

- A. Escort through Aisle of Honor Commander-in-Chief or National President, alone, with Bible open.
(There is no Aisle of Honor without the Colors.)
- B. Escort to the President's station by Conductor and Asst. Conductor (if necessary).
- C. The following to be escorted into meeting at the **same time** and presented in order as listed:
 - National Elected Officers
 - Past National Presidents
 - National District Council Members and National Appointed Officers
 - National Ambassadors and National Chairmen

Department President is to be escorted **first and alone** when making Official Visit.

Past Department Presidents, all visiting Department Presidents and Department Officers.

District President is to be escorted **first and alone** when making Official Visit as a representative of the Department President.

All National Officers and Past National Presidents are to be seated to the immediate right of the presiding Officer.

At the time of the Official Visit of Department President, they shall be seated to the immediate right of the presiding Officer. Their official representative shall be accorded the same courtesies.

All Department Officers are to be seated to the immediate left of the presiding Officer.

3. ROLL CALL OF AUXILIARIES (*District Only*)

Items 4, 4a, 4b and 4c are for Auxiliary Order of Business only.

4. READING AND REFERRING OF APPLICATIONS FOR MEMBERSHIP

President: Mister/Madam Secretary, do we have any applications for membership?

Secretary: Mister/Madam President, we have (or don't have).

Secretary reads names of applicants.

4a. REPORT OF INVESTIGATING COMMITTEE

President: We will now have the report of the investigating committee.

The committee will recommend election or rejection in accordance with Section 102 of the National Bylaws.

4b. VOTING ON CANDIDATES

Follow the procedure set forth in Section 103 of the National Bylaws.

President: If there is no objection, we will have a voice vote to accept this candidate.

President: Mister/Madam Secretary, you will notify the applicant (or applicants) to present themselves for initiation at the proper time.

4c. INITIATION *(See page 78 for Member Initiation.)*

5. PRESENTATION OF MINUTES AND OFFICIAL AND OTHER COMMUNICATIONS *(Manner of presentation is by the vote of the Auxiliary.)*

President: We will now have the presentation of the minutes of the previous meeting.

Are there any corrections?

If none—The minutes will stand approved as read.

If corrected—The minutes will stand approved as corrected.

President: We will now have the presentation of official and other communications by the Secretary.

6. TREASURER’S REPORT *(Manner of presentation is by the vote of the Auxiliary.)*

President: Mister/Madam Treasurer, please present the Treasurer’s Report.

The Treasurer gives the report of the previous meeting.

President: Is there any discussion pertaining to the Treasurer’s Report? If not, the Treasurer’s Report will be filed subject to audit.

7. PRESENTATION OF BILLS

Bills to be read by Secretary, then Conductor takes bills to Trustees for approval.

8. INTRODUCTION OF GUESTS, WHO ARE NOT ESCORTED

- A. Department Chairman of standing committees to be recognized from the floor.
- B. Other member guests to be recognized from the floor
- C. Introduce non-member guests. *(Any non-Auxiliary member guest shall not be allowed to enter the room until the Treasurer’s Report and Presentation of Bills has concluded.)*

9. REPORTS OF COMMITTEES, STANDING AND SPECIAL

President: Reports of Committees, standing and special, is the next business in order.

Call on all committees, including Program Chairmen.

The Audit Report is called for after each quarterly audit and is the ONLY REPORT accepted by motion.

10. UNFINISHED BUSINESS

President: Next we will have Unfinished Business.

The Secretary should be prepared to remind the President of any unfinished business.

11. NEW BUSINESS

President: The next order of Business is New Business.

Under New Business—Draping of Charter, Election of Officers, etc.

Nominations and Elections of Officers are outlined on pages 42 to 48. Voting is clarified in Section 805 of the National Bylaws.

12. REPORT OF TRUSTEES

President: We will now have the Report of Trustees.
(Motion is required for payment of bills.)

13. SUGGESTIONS FOR THE GOOD OF THE ORDER

President: Are there any Suggestions for the Good of the Organization?

Instructions by Patriotic Instructor; new members and guests should be invited to speak at this time.

14. CLOSING CEREMONIES

President: Is there anything further to come before this meeting? (Pause)

If not, this concludes our business. Officers, present yourselves at the Altar for the closing ceremonies.

Two (2) raps.

When directed to present themselves at the Altar, the Conductor and Chaplain advance to the Altar. When in line at Altar, Chaplain takes one (1) step forward and then offers the closing prayer.

President: **Parade rest!**

CLOSING PRAYER

Chaplain: **Heavenly Father, the hour has now come when we must separate; commit us to Thy tender mercy and care. We thank Thee for Thy many blessings and beg of Thee to preserve our Auxiliary. Help us to make it one of faithfulness, charity and true patriotism. May the grace, mercy, peace and blessing of God the Father be with each and every one of us. Amen.**

All: **Amen.**

The Chaplain closes the Bible.

The Chaplain takes one (1) step back into line with Officers.

President: **We are about to leave this Auxiliary room. Let us endeavor to so regulate our conduct that it will bring honor to our organization. I now declare this meeting closed with the retiring of the Colors. The next meeting will be _____.**

The President gives one (1) rap to indicate adjournment.

CONTEMPORARY MEETING

(Floor work is optional with this version. If floor work is performed, it shall be as directed in the Traditional Meeting).

AUXILIARY ORDER OF BUSINESS

1. Opening Ceremonies
2. Introduction of National and/or Department Officers
3. Roll Call of Auxiliaries (*District only*)
4. Reading and Referring of Applications for Membership
 - a. Report of Investigating Committee
 - b. Voting on Candidates
 - c. Initiation (*optional*)
5. Presentation of Minutes and Official and Other Communications
6. Treasurer's Report of Previous Meeting
7. Presentation of Bills
8. Introduction of Guests
9. Reports of Committees, Standing and Special
10. Unfinished Business
11. New Business (*May include Draping of Charter, Elections/Installation of Officers, etc.*)
12. Report of Trustees and Action Thereon
13. Suggestions for the Good of the Order
14. Closing Ceremonies

1. OPENING CEREMONIES

President gives one (1) rap of gavel.

President: **We welcome all members and guests. All are reminded that only members of this Auxiliary may participate in discussion and voting.**

President: **Mister/Madam Guard, please close the doors and allow no one to enter until the opening ceremonies have been concluded.**

Guard: **Yes, Mister/Madam President.**

President: **Mister/Madam Conductor (and Assistant Conductor, satisfy yourself that all present are entitled to remain.**

Two (2) raps.

The Conductor will examine each member's dues card, assisted as directed by the President unless the Guard has already done so. Those found in possession of the official Auxiliary membership dues card for the current calendar year may be seated. Conductor then advances to the Altar.

Conductor (and Assistant Conductor: **Mister/Madam President, I find all, except those standing, in possession of the official membership dues card for the current calendar year.**

If Assistant Conductor assists, Conductor checks those to the President's right; Assistant Conductor checks those to the President's left.

President instructs Treasurer to determine the status of members standing. Those who have not paid their current dues will be required to pay said dues or leave the meeting room.

President: **Mister/Madam Secretary, please call the roll of the Officers.**

At the command of the President to call the roll, both Secretary and Conductor rise. The Secretary calls the title and name of each Officer, who will rise and remain standing until all have been called. The Conductor responds "present" or "absent." President announces pro tem Officers.

President: **Officers, present yourselves at the Altar for the Opening Services.**

Two (2) raps.

At the command of the President, the Conductor, Chaplain and Patriotic Instructor rise and advance to rear of Altar. Once in a straight line, the Chaplain takes one step forward, reverently opens the Bible and places it in the center of the Altar.

President: **Chaplain will now offer the opening prayer.**

President: **Parade Rest.**

OPENING PRAYER

Chaplain: **As we gather here today as members of the VFW Auxiliary, we pray that we are ever mindful of opportunities to render our services to veterans. Guide us in our deliberations that we may make sound decisions for our Auxiliary. Amen.**

All: **Amen.**

Chaplain takes one (1) step back in line with Officers.

President: **Attention!**

Patriotic Instructor: **Let us be ever mindful of our duties as members of the Veterans of Foreign Wars of the United States Auxiliary, to see that our Flag is never desecrated and to teach the people of our land what this means and to see that all are instructed in the pledge to the Flag.**

President: **You will salute and give pledge to the Flag.**

All rise and face Patriotic Instructor's Flag.

I PLEDGE ALLEGIANCE to the Flag of the United States of America and to the REPUBLIC for which it stands, (pause) one nation under GOD, (pause) INDIVISIBLE, (pause) with LIBERTY and JUSTICE FOR ALL. (Emphasis is given to the words in capital letters.)

(Optional) President: **We will now sing the National Anthem, Salute!**

Heart Salute or Military Salute (veterans) is used any time the National Anthem is played or sung.

**Oh, say, can you see by the dawn's early light,
What so proudly we haled at the twilight's last gleaming?
Whose broad stripes and bright stars thru' the perilous fight,
O're the ramparts we watch'd were so gallantly streaming;
And the rockets' red glare, the bombs bursting in air,
Gave proof thru' the night that our Flag was still there.
Oh, say, does that star spangled banner yet wave
O're the land of the free, and the home of the brave?**

President: **Attention!**

President: **We have been permitted to assemble again in this room and I trust that the business transacted here will be for our mutual benefit. Remember the duty we owe one another and if we carry out daily the lessons and principles taught in this Auxiliary room, our country will be better that we have existed. Let all our actions bring honor to our cause.**

President: **Officers, please return to your stations.**

The Conductor, Chaplain and Patriotic Instructor about face and process to stations.

Three (3) raps.

President: **I now declare this Auxiliary meeting open for the transaction of such business as may properly come before it. Mister/Madam Guard, admit any member who may be in waiting.**

2. ESCORT AND INTRODUCTION OF GUESTS AUXILIARY/DISTRICT

- A. The Conductor brings in the current Commander-in-Chief or National President via the Aisle of Honor (*See page 5, Escorting Guests. The Aisle of Honor is to be used only for the current Commander-in-Chief or National President.*)

B. The following are to be brought into meeting at the **same time** and presented in order as listed:

- National Elected Officers
- Past National Presidents
- National District Council Members and National Appointed Officers
- National Ambassadors and National Chairmen

Department President is to be brought in **first and alone** when making Official Visit.

Past Department Presidents, all visiting Department Presidents and Department Officers.

District President is to be brought in **first and alone** when making Official Visit as a representative of the Department President.

3. ROLL CALL OF AUXILIARIES (*District only*)

Items 4, 4a, 4b and 4 c are for Auxiliary order of business only.

4. READING AND REFERRING OF APPLICATIONS FOR MEMBERSHIP

President: **Mister/Madam Secretary, do we have any applications for membership?**

Secretary: **Mister/Madam President, we have (or don't have).**

Secretary reads names of applicant(s).

4a. REPORT OF INVESTIGATING COMMITTEE

President: **We will now have the report of the investigating committee.**

The committee will recommend election or rejection in accordance with Section 102 of the National Bylaws.

4b. VOTING ON CANDIDATES

Follow the procedure set forth in Section 103 of the National Bylaws.

President: If there is no objection, we will have a voice vote to accept this candidate.

President: Mister/Madam Secretary, you will notify the applicant (or applicants) to present themselves for initiation at the proper time.

4c. INITIATION *(Optional. See page 78 for Member Initiation.)*

5. PRESENTATION OF MINUTES AND OFFICIAL AND OTHER COMMUNICATIONS *(Manner of presentation is by the vote of the Auxiliary.)*

President: We will now have the presentation of the minutes of the previous meeting.

Are there any corrections?

If none —The minutes will stand approved as read.

If corrected—The minutes will stand approved as corrected.

President: We will now have the presentation of official and other communications by the Secretary.

6. TREASURER’S REPORT *(Manner of presentation is by the vote of the Auxiliary.)*

President: Mister/Madam Treasurer please present the Treasurer’s Report.

The Treasurer gives the report of the previous meeting.

President: Is there any discussion pertaining to the Treasurer’s Report? If not, the Treasurer’s Report will be filed subject to audit.

7. PRESENTATION OF BILLS

President: **We will now have the presentation of any bills.**

Bills to be read by Secretary, then Conductor takes bills to Trustees for approval.

8. INTRODUCTION OF GUESTS

- A. Department Chairman of standing committees to be recognized from the floor.
- B. Other member guests to be recognized from the floor
- D. Introduce non-member guests. *(Any non-Auxiliary member guest shall not be allowed to enter the room until the Treasurer's Report and Presentation of Bills has concluded.)*

All National Officers and Past National Presidents are to be seated to the immediate right of the presiding Officer.

At the time of the Official Visit of Department President, they shall be seated to the immediate right of the presiding Officer. Their official representative shall be accorded the same courtesies.

9. REPORTS OF COMMITTEES

President: **Reports of Committees, standing and special, is the next business in order.**

Call on all committees, including Program Chairmen.

The Audit Report is called for after each quarterly audit and is the ONLY REPORT accepted by motion.

10. UNFINISHED BUSINESS

President: **Next we will have Unfinished Business.**

The Secretary should be prepared to remind the President of any Unfinished Business.

11. NEW BUSINESS

President: **The next order of Business is New Business.**

12. REPORT OF TRUSTEES

President: **We will now have the Report of Trustees and action thereon.** (Motion required.)

13. SUGGESTIONS FOR THE GOOD OF THE ORDER

President: **Are there any Suggestions for the Good of the Organization?**

Instructions by Patriotic Instructor; new members and guests should be invited to speak at this time.

14. CLOSING CEREMONIES

President: **Is there anything further to come before this meeting?** (*Pause*)

If not, this concludes our business. Officers, please present yourselves at the Altar for the closing ceremonies.

Two (2) raps.

When directed to present themselves at the Altar, the Conductor and Chaplain advance to the Altar. When in line at Altar, Chaplain takes one (1) step forward and then offers the closing prayer.

President: **Parade rest!**

CLOSING PRAYER

Chaplain: **We are thankful to come together for the good of our veterans. We pray for strength to continue to strive to serve others. Please bless us in our work until we meet again. Amen.**

All: **Amen.**

The Chaplain closes the Bible.

The Chaplain takes one (1) step back into line with the officers.

President: **Attention!**

President: **I would like to remind us all of our purpose as an Auxiliary, which is to serve veterans and their families. Let each of us treat one another with respect and kindness at all times. I now declare this meeting closed. The next meeting will be _____.**

The President gives one (1) rap to indicate adjournment.

ROUNDTABLE MEETING

(This meeting version includes no floor work or Ritual, and is designed to use members' time as efficiently as possible. It is highly recommended that newly instituted Auxiliaries use either Traditional or Contemporary meetings for six (6) months until they become more familiar with the Ritual of the VFW Auxiliary.)

At the wish of the Auxiliary, meetings may be conducted according to *Robert's Rules of Order, Newly Revised*, thus a Roundtable Meeting is held.

The following items must be included in the Roundtable Meeting:

- Checking Dues Cards
- Roll Call of Officers
- Opening Prayer
- Pledge of Allegiance
- Minutes
- Treasurer's Report
- Business (to include Program information)
- Closing Prayer

ELECTIONS OF OFFICERS AUXILIARIES/DISTRICTS

According to established precedent, the following is the procedure in the election of Auxiliary/District Officers.

Offices to be elected:

- President
- Senior Vice-President
- Junior Vice-President
- Treasurer
- Chaplain
- Conductor
- Guard
- Three-Year Trustee

President: The next business in order will be the election of Officers and while such election of Officers is in progress, no member may enter or leave the room during the election of any one Officer except for valid reasons; in which case, they shall not be permitted to re-enter the room until that one (1) Officer is elected. After members have voted and the ballot is declared closed, a member who has not voted is not permitted to vote.

All members in good standing are entitled to vote. No member can be compelled to vote.

Nominations may be made from the floor or the President's station. Nominations do not have to be seconded.

If there are no objections, the Chair will close the nominations after calling for further nominations three (3) times, following the last nomination for that office.

Should you notice any discrepancies/errors, please call them to the attention of the Judge and Tellers immediately rather than waiting until the meeting is closed to contest an election. Once the meeting is closed and the Bylaws have been followed, the outcome of an election cannot be refuted. *(See Robert's Rules of Order, Newly Revised.)*

President: **In the event we may have two (2) or more candidates for any one office, I appoint _____ as Judge and _____ as Tellers.**

The Judge shall announce the number of members in the room entitled to vote, the number of votes cast, and the number of members not voting, and will give the majority vote at the conclusion of the counting.

PROCEDURE WHEN THERE IS ONLY ONE (1) CANDIDATE FOR AN OFFICE

President: **Nominations are now open for the office of _____.** *(Someone nominates the candidate.)*

President: **Are there any further nominations?**

One (1) rap.

Are there any further nominations?

One (1) rap.

Are there any further nominations?

One (1) rap.

After calling for further nominations three (3) times

President: **Hearing no further nominations, I hereby declare _____ elected by acclamation as _____ for the ensuing year.**

President: **Brother/Sister _____, do you accept this office?**

Officer-elect: **I do.** *(Words of gratitude and pledge of service may be given here by the Officer-elect, but should be very short.)*

President: **I herewith declare Brother/Sister _____ duly elected as _____ for the ensuing year.**

One (1) rap.

Repeat for each elected position listed at the start of this section.

PROCEDURE WHEN THERE ARE TWO (2) OR MORE CANDIDATES FOR AN OFFICE

President: **Nominations are now open for the office of _____.** (*Someone nominates the candidates.*)

President: **Are there any further nominations?**

One (1) rap.

Are there any further nominations?

One (1) rap.

Are there any further nominations?

One (1) rap.

After calling for further nominations three (3) times,

President: **Hearing no further nominations, for the office of _____ are closed.**

One (1) rap.

President: **Brother/Sister _____ and Brother/Sister _____ have been nominated for the office of _____.** (*Add other names as necessary.*)

President: **Mister/Madam Conductor, please pass out the ballots.**

President: **Once you have completed your ballot, you may deposit your ballot in the ballot box at the Tellers' table.**

or

President: Mister/Madam Conductor, please to pass the ballot box to each member so that they may put their ballot in the box. Then please place the ballot box on the Tellers' table.

After all have cast their ballot.

President: I declare the balloting closed for the office of _____. The Judge and Tellers shall proceed with counting the ballots.

Following the counting of the ballots.

Judge: As a courtesy to our candidates, please refrain from applause when the results are announced. You may applaud the remarks made by all candidates after they address the delegation:

“We find _____ votes for _____ and _____ votes for _____. By your majority vote, you have elected candidate _____.” *(Add more names as necessary.)*

President: Brother/Sister _____, do you accept this election?

Officer-elect: I do. *(Words of gratitude and pledge of service may be given here by the Officer-elect, but should be very short.)*

President: I herewith declare Brother/Sister _____ duly elected as _____ for the ensuring year.

Repeat for each elected position listed at the start of this section.

See page 46 in the case of District Elections--By Ballot or Roll Call of Auxiliaries and District Officers.

DISTRICT ELECTIONS BALLOT VOTE BY AUXILIARY

(See the format under Auxiliary Election of Officers.)

DISTRICT ELECTIONS ROLL CALL VOTE BY AUXILIARY

On a roll call vote, the Chairman of the Credentials Committee calls the roll of registered Delegates, giving the delegate strength in Auxiliary numerical order followed by those who have their own individual vote—in accordance with Section 503.

The Auxiliary number is called.

In accordance with Section 805—Voting, “In the President’s absence, the Senior Vice-President, or in their absence, the Junior Vice-President, shall be vested and directed to cast the entire voting strength subject to the will of the delegation present at the convention. Any of the three may cast the President’s vote. If all are absent, the vote shall be taken by roll call of the Auxiliaries within the District and the President’s vote is lost.”

The President (*see above*) gives the number of votes for each candidate, which shall add up to the delegate strength given by the Chairman of Credentials. The Chairman of Credentials repeats the numbers given for the Judge and Tellers. Once the roll call of Auxiliaries is completed, the Chairman of Credentials moves on to those with individual vote, repeating the individual vote for the Judge and Tellers.

After all have cast their ballots/votes.

President: I declare the balloting/voting closed for the office of Auxiliary/District President. The Judge and Tellers shall proceed with counting the ballots/votes.

One (1) rap.

Judge and Tellers count and determine the majority based on the Credentials Report and then the Judge announces

Judge: As a courtesy to our candidates, please refrain from applause when the results are announced. You may applaud the remarks made by all candidates after they address the delegation:

“We find _____ votes for _____ and _____ votes for _____. By your majority vote, you have elected candidate _____.”

President: Brother/Sister _____, do you accept this election?

Officer-elect: I do. *(Words of gratitude and pledge of service may be given here by the Officer-elect, but should be very short.)*

President: I herewith declare Brother/Sister _____ duly elected as _____ for the ensuing year.

One (1) rap.

President: Judge and Tellers, you are dismissed. Thank you for your service.

President: (Auxiliary) Newly elected Officers, you will be installed at our next regular (or special) meeting on _____.

At the meeting where Installation will take place, see page 49 for Installation of Officers - Auxiliaries/Districts.

President: (Auxiliary) Is there any other new business?

Is there anything further to come before this meeting?

If not, Officers present yourselves at the Altar for the closing ceremonies.

or

President: **(District) Newly elected Officers, we will take a _____ minute break after which, the Officers will be installed.**

*See page 49 for Installation of Officers - Auxiliaries/
Districts.*

INSTALLATIONS OF OFFICERS AUXILIARIES/DISTRICTS

(The following Diagram is the lineup of Officers for the Installation.)

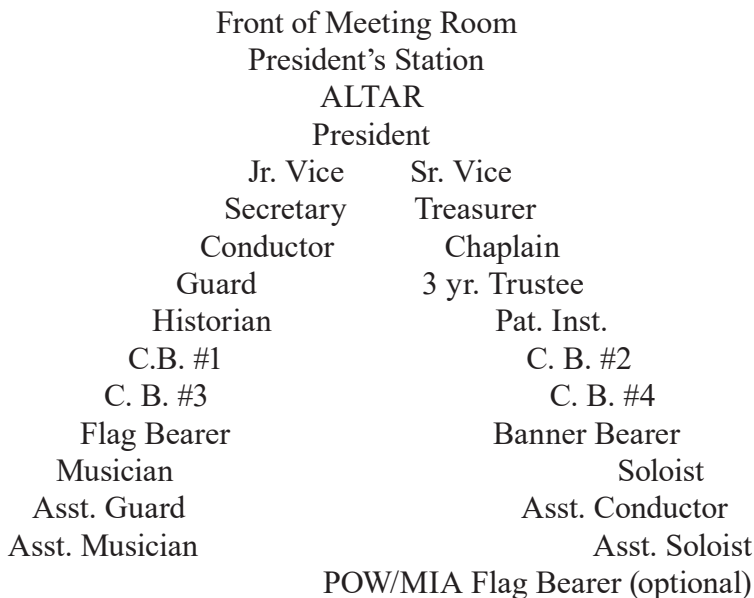

President: **The Installing Officer is present for the purpose of installing Officers of this Auxiliary.**

Mister/Madam Conductor, escort the Installing Officer to this station.

Two (2) raps.

President: **I have the honor of presenting Brother/Sister _____, who has been chosen to install the Officers of this Auxiliary. As a member of the Veterans of Foreign Wars of the United States Auxiliary, we extend to you a cordial welcome. I have the honor to turn over to you the command of this Auxiliary.**

Three (3) raps.

Installing Officer will then take President's station, the President stepping to the left.

Installing Officer: **Ladies and gentlemen, the purpose of my visit being fully understood we will proceed at once with our duties.**

Installing Officer: **Mister/Madam President, have all Officers been elected or appointed for the ensuing year?**

President: **They have.**

Installing Officer: **Have all dues for this Auxiliary been duly forwarded as required?**

President: **They have.**

Installing Officer: **Mister/Madam President, have the books of the Secretary and Treasurer been audited and a report made of same?**

President: **They have.**

Installing Officer: **Mister/Madam President, has the office of Treasurer been bonded?**

President: **It has.**

Installing Officer: **Mister/Madam Secretary you will read the names of the Officers for the ensuing year commencing with the President. As your name is called, you will please rise. Chairmen are not to be installed.**

Installing Officer: **Mister/Madam Conductor (and Assistant Conductor, you will escort the Officers to the Altar.**

If any of the retiring Officers are among those to be installed, they will vacate their stations. These stations need NOT be filled as long as Officers are in the room. When all Officers are in position at the Altar, Installing Officer will give two (2) raps, then proceed directly between Color Bearers 1 and 2 to position in front of the Altar.

Conductor: Mister/Madam Installing Officer, all Officers are in position to receive the obligation.

Installing Officer: Mister/Madam President-Elect before administering to you the obligation, it will be necessary to remind you of some of the duties of your office and to ask you to promise to perform the same to the best of your ability. It shall be your duty:

To have charge of the charter and other property of the Auxiliary; keep them safely and at the end of your term of office, deliver them either to your successor, the National President or their representative;

To have general supervision over the Officers of this Auxiliary with a view to the faithful performance of their duties;

To exact obedience to the Bylaws of the National Auxiliary;

To pay due respect to the National and Department Officers or their representatives;

To be firm in the discharge of your duties, but strive to promote harmony in the meetings and advance the interests of our organization by being kind and courteous to all our members.

Are you willing to promise on your word of honor to perform these duties faithfully?

President-Elect: I am.

Installing Officer: Officers, you have been chosen to fill important offices in your Auxiliary. It is necessary that the duties of your position be intelligently and faithfully discharged. Are you willing to assume the duties of the office to which you have been chosen, and do you promise to perform the same to the best of your ability?

Officers-Elect: I do.

Installing Officer: You will raise your right hand and repeat after me, the Officers' obligation:

In the presence of the members— of this organization here assembled— I do solemnly promise— on my sacred honor— to perform faithfully, strictly and impartially—all the duties of the office— upon which I am about to enter. I will at the end of my term of office— or sooner if so ordered by proper authority— surrender immediately to only duly authorized person or persons— all records, money or other properties of this organization— in my possession or under my control. I do so promise.

Let us pray:

Dear God, may we feel Thy nearness as we bow our heads and ask Thy blessing upon those who have assumed office in this great organization. Make them conscious of the responsibilities they have assumed. Give them courage, strength and a will to forego personal ambitions and strive only to serve others. Guide and direct our hearts and minds so that we may better serve Thee and the Veterans of Foreign Wars. Amen.

Installing Officer returns to their station.

Three (3) raps.

Installing Officer: Mister/Madam Conductor, you will escort the President to this station.

Mister/Madam Conductor-and Assistant Conductor, you will escort the Officers to their respective stations. Officers remain standing until your charge is given.

Conductor: Mister/Madam Installing Officer, the Officers are at their respective stations.

Installing Officer: Thank you, Mister/Madam Conductor and Assistant Conductor. You are dismissed.

Installing Officer (Optional): I will dispense with the reading of the Officers' Duties and proceed directly to the Duties of the President. Officers you will acquaint yourself with your duties.

Installing Officer: Mister/Madam Senior Vice-President—It shall be your duty to assist the President in preserving order and in their absence to preside over the meeting. Learn well the duties of their office, so that in their absence you may feel yourself confident to take their place.

Mister/Madam Junior Vice-President—It shall be your duty to assist the President and Senior Vice-President in the discharge of their duties and in the absence of both, to preside over the meeting.

Mister/Madam Secretary—In appointing you as Secretary of this Auxiliary, the President has shown that they have confidence in your ability to assist them. You shall keep a true record of the proceedings of this Auxiliary and attend to all matters of correspondence under the direction of the President. You shall perform such other duties as the Bylaws may require.

Mister/Madam Treasurer—It shall be your duty to be sole custodian of all funds and securities belonging to the Auxiliary. You shall keep a record of each member and notify promptly all members in arrears. You shall give receipts for all money received and shall pay out money approved at stated meetings. You shall render at each meeting an itemized statement of receipts and expenditures, and perform such other duties as the Bylaws require.

Mister/Madam Chaplain—The sacred duties of your office are in themselves a solemn obligation. You shall obligate new members and perform such other duties as the Ritual directs, and by your own life and conduct, prove a bright example to your Brothers and Sisters.

Mister/Madam Conductor—It shall be your duty at the opening of each meeting to see that all those present are entitled to remain; assist in the floor work ceremonies and at initiation. As the first impression on a stranger is made by you, you should be familiar with all our workings so that the impression may be a good one.

Mister/Madam Guard—You shall guard the doors, and by your watchfulness, see that only those eligible enter.

Mister/Madam Trustees—It shall be your duty to carefully audit the books and records of the Secretary and Treasurer and perform such other duties as may be necessary.

Mister/Madam Color Bearers, Flag Bearer, Banner Bearer and POW/MIA Flag Bearer—It shall be your duty to take care of the Colors and Banner at the Auxiliary meetings and perform such other duties as the President directs.

Mister/Madam Historian—It shall be your duty to keep a written record of the history of your Auxiliary. A pictorial record may be kept for the Auxiliary President.

Mister/Madam Patriotic Instructor—You have been appointed to this high office to teach patriotism and good citizenship to the people of our country; to assist in the floor work ceremonies and perform such other duties as the Ritual may require.

Mister/Madam Musician—Yours is an important office. It shall be your duty to be present at every meeting before the meeting is called to order, so that you may assist the President in opening the meeting; in conducting the initiation work and in closing the meeting. Your prompt attendance will be appreciated by the President and Auxiliary members.

Mister/Madam Soloist—It shall be your duty to lead the members in the National Anthem, the songs for the Draping of the Charter and the Memorial Services.

(Resume Installation here, if other Officers' Duties were omitted.)

Mister/Madam President—You have been elected to the highest office in this Auxiliary and many responsibilities will rest on you, but the fact that you have been elected by the members of the Auxiliary indicates they have confidence in your ability and integrity, and they feel assured, you will strictly and impartially discharge all the duties incumbent upon you. As President, it shall be your duty:

To preside at all meetings; to appoint all Officers and Committees not otherwise provided for and to see that the Officers of this Auxiliary perform their respective duties in a proper manner.

I now present you with this gavel, your emblem of authority, use it firmly, but with discretion and remember the President is expected to set a good example. The success of this Auxiliary for the coming year depends in a great measure upon your wise conduct of its affairs.

Brothers and Sisters, I now present to you the Officers of your choice. I counsel you to aid them in the performance of their duties and with your help, this term of office will be successful. I commend all to cherish the principles upon which this organization was founded and with the Officers you have chosen, I trust these principles will be carried out. I wish to extend the best wishes of the National and Department Officers for the success of _____ Auxiliary. By the power vested in me, I now declare the Officers of _____ Auxiliary duly installed for the term to which they have been elected or appointed.

One (1) rap.

DEPARTMENT MEETINGS AND OFFICER INSTALLATION

SUGGESTED AGENDA FOR A COUNCIL OF ADMINISTRATION MEETING

Recommended: Verify member has current membership card when entering room.

- | | |
|---|-----------|
| 1. Call to Order
<i>(One (1) rap.)</i> | President |
| 2. Roll Call | Secretary |
| 3. Opening Prayer | Chaplain |
| 4. Pledge of Allegiance | |
| 5. Reading of Minutes
<i>(May be printed and accepted as printed or corrected.)</i> | |
| 6. Official Communications | |
| 7. Introduction of New Council Members
<i>(District Presidents—First meeting after convention)</i> | |
| 8. Financial Report | |
| 9. Budget Chairman's Report | |
| 10. Audit Committee's Report | |
| 11. Unfinished Business
<i>(Secretary advises President from previous minutes.)</i> | |
| 12. New Business
<i>(Ask Guests to speak)</i> | |
| 13. Announcements | Secretary |
| 14. Closing Remarks | President |
| 15. Closing Prayer | Chaplain |

SUGGESTED DEPARTMENT CONVENTION ORDER OF BUSINESS

Recommended: Verify member has current membership card when entering room.

1. Opening of Convention
2. Roll Call of Officers
(On roll call at the opening session of the Department Convention, each Officer, as their name is called, shall rise and remain standing until the roll call is completed.)
3. Ritualistic Opening
4. Escort of National Representative and Others as per page 27.
5. Reading of Minutes of Previous Convention
(May be printed and accepted as printed or corrected.)
6. Announcement of Committees
7. Report of Convention Rules Committee
8. Report of Officers, beginning with that of President
(May be part of printed Officers' reports and not read on the floor.)
 - a. Financial Report to be printed in its entirety.
9. Official Communications
10. Resolutions Committee
11. Program Awards
12. Draping of Charter and Memorial Service
13. New Business
 - a. Reports of Convention Committees
 - b. Credentials Committee Report
 - c. Nomination and Election of Officers
14. Installation of Officers
15. Presentation of Past Department President's Jewel
16. Closing Ceremonies

DEPARTMENT CONVENTION

ESCORT OF GUESTS

1. Commander-in-Chief or National President alone through the Aisle of Honor.

2. National Representative

A representative of the National President shall be escorted alone to the platform, not through the Aisle of Honor, and introduced in the same order of precedence as the National President and seated to the immediate right of the presiding Officer.

3. The following to be escorted into meeting at the **same time** and presented in order listed:

- National Elected Officers
- Past National Presidents
- National District Council Members and National Appointed Officers
- National Ambassadors and National Chairmen
- Past Department Presidents and all visiting Department Presidents and Department Officers

4. Department Commander—alone, and Department President—alone, when returning from visiting VFW meeting.

DEPARTMENT ELECTIONS OF OFFICERS

Nominations may be made on day one and concluded on the final day of a Department Convention. The President would call for nominations twice on day one and once on the final day if this method is selected. Below you will find a script for use when there is only one (1) candidate for an office as well as a script for use when there are two (2) or more candidates for the same office.

Offices to be elected:

- Department President
- Department Senior Vice-President
- Department Junior Vice-President
- Department Treasurer
- Department Chaplain
- Department Conductor
- Department Guard
- National District Council Member (*Only when*

it is the Department's turn as directed by the National Bylaws, Section 804E.)

INSTRUCTIONS PRIOR TO OPENING THE NOMINATIONS

President: The next business in order will be the election of Officers and while such election of Officers is in progress, no member may enter or leave the room during the election of any one Officer except for valid reasons; in which case, they shall not be permitted to re-enter the room until that one Officer is elected. Also, after members have voted and the ballot is declared closed, a member who has not voted is not permitted to vote.

All members in good standing are entitled to vote. No member can be compelled to vote.

Nominations may be made from the floor or the President's station. Nominations do not have to be seconded.

If there are no objections, the Chair will close the nominations after calling for further nominations three (3) times, following the last nomination for that office.

It is most important that any discrepancies/errors, etc. in the election of any one Officer be immediately brought to the attention of the Credentials Chairman and before the election of the next Officer so that discrepancies/errors may be rectified

at that point in time rather than waiting until the convention has closed to contest an election. Once the convention is closed and the Bylaws have been followed, the outcome of an election cannot be refuted. (*See Robert's Rules of Order, Newly Revised.*)

President: **In the event we may have two (2) or more candidates for any one office, I appoint _____ as Judge and _____ and _____ as Tellers.**

The Judge shall announce the number of members in the room entitled to vote, the number of votes cast, and the number of members not voting, and will give the majority vote at the conclusion of the counting.

President: **Nominations are now open for the office of _____.** (*Someone nominates the candidate.*)

The name of _____ has been placed in nomination for _____.

or

The names of _____ and _____ have been placed in nomination for _____.

Are there any further nominations?

One (1) rap.

Are there any further nominations?

One (1) rap.

Pause.

At the discretion of the presiding President, nominations may be made on one day and concluded another day, or nominations may be made and elections held on the same day.

Nominations will remain open until tomorrow.

One (1) rap.

Repeat for each of the positions listed at the start of this section.

Following nominations, the President would resume the order of business for the remainder of that session or following announcements by the Department Secretary, adjourn the meeting to resume at _____ a.m. tomorrow.

FINAL ELECTION OF OFFICERS

President: **The names of _____ and _____ have been placed in nomination for _____.**

Are there any other nominations?

Should there be a nomination, the President would then call for nominations three (3) times.

President: **Are there any further nominations?**

One (1) rap.

Are there any further nominations?

One (1) rap.

If only one (1) nomination, proceed.

President: **Hearing no further nominations, I hereby declare _____ elected by acclamation as _____ for the ensuing year. Brother/Sister _____ do you accept this office?**

Officer-elect: **I do.** *(Words of gratitude and pledge of service may be given here by the Officer-elect, but should be very short.)*

President: **I herewith declare Brother/Sister _____ duly elected as Department President for the ensuing year.**

One (1) rap.

Repeat for each elected position listed at the start of this section.

ELECTION PROCEDURE, TWO (2) OR MORE CANDIDATES

Department elections may be conducted by roll call of Districts or Auxiliaries.

President: **While such election of Officers is in progress, no member may enter or leave the room during the election of any one Officer except for valid reasons; in which case, they shall not be permitted to re-enter the room until that one (1) Officer is elected. Also, after members have voted and the ballot declared closed, a member who has not voted is not permitted to vote.**

It is most important that any discrepancies/errors, etc. in the election of any one Officer be immediately brought to the attention of the Credentials Chairman and before the election of the next Officer so that discrepancies/errors may be rectified at that point in time rather than waiting until the convention has closed to contest an election. Once the convention is closed and the Bylaws have been followed, the outcome of an election cannot be refuted. (See Robert's Rules of Order, Newly Revised.)

I have appointed _____ as Judge and _____ and _____ as Tellers.

In accordance with Section 805, Voting, "In the President's absence, the Senior Vice-President, or in their absence, the Junior Vice-President, shall be vested and directed to cast the entire voting strength subject to the will of the delegation present at the convention. (Any of the three (3) may cast the President's vote.) If all are absent, the vote shall be taken by roll call of the Auxiliaries within the Department and, the President's vote is lost."

After the District/Auxiliary President has a report from the Credentials Chairman and has polled the Delegates/Auxiliaries present (if voting by Districts), the District President/Auxiliary (*see above*) gives the number of votes for each candidate (which shall add up to the delegate strength given by the Credentials Chairman.)

The Credentials Chairman repeats the numbers given for the Judge and Tellers.

The Credentials Chairman will conduct a roll call vote. *(Suggested order of voting is by Districts or Auxiliaries, followed by those with individual vote, and finally by Department Officers in reverse order-meaning the Department President is the last name called provided they are voting as the Department President and not as a Delegate.)*

After the last name is called and their vote given.

President: **I declare this election closed.**

One (1) rap.

Judge and Tellers count and determine the majority based on the Credentials Report and then the Judge announces

Judge: **As a courtesy to our candidates, please refrain from applause when the results are announced. You may applaud the remarks made by all candidates after they address the delegation:**

“We find _____ votes for _____ and _____ votes for _____. By your majority vote, you have elected candidate _____.”

President: **Brother/Sister _____, do you accept this election?**

Officer-elect: **I do.** *(Words of gratitude and pledge of service may be given here by the Officer-elect, but should be very short.)*

President: **I herewith declare Brother/Sister _____ duly elected as _____ for the ensuing year.**

Repeat for each elected position listed at the start of this section.

One (1) rap.

After all Officers have been elected,

**President: This concludes our election of Officers for
20___-20___.**

One (1) rap.

**President: Judge and Tellers, you are dismissed. Thank
you for your service.**

The Department President continues according to the customary practice of their Department. In accordance with Section 806D of the National Bylaws, the President-elect selects the Installing Officers and any other customary positions.

- A short break may be allowed to set up for Installation, etc., with Installation following.

- After Installation of Officers for the ensuing year and such things as an acceptance speech by the incoming Department President, pinning of the incoming Department President's pin and presentation of the outgoing Department President's Past President's pin, etc., the current year's offices conduct the Closing Ceremonies.

- If the Installation of Officers is to follow after the Closing Ceremony has been concluded, permission of the National President is needed.

**President: Is there anything further to come before this
meeting?**

INSTALLATION OF DEPARTMENT OFFICERS

Department President: **The Installing Officer is present for the purpose of installing the Officers of this Department.**

Mister/Madam Conductor, you will escort the Installing Officer to this station.

Two (2) raps.

Department President: **I have the honor of presenting Brother/Sister _____, who has been chosen to install the Officers of this Department. As a member of the Veterans of Foreign Wars of the United States Auxiliary, we extend to you, a cordial welcome. I have the honor to turn over to you, the command of this Department.**

Three (3) raps.

Installing Officer takes position of presiding Officer; the presiding Officer steps to the left.

Installing Officer: **The purpose of my presence here being fully understood we will proceed at once with our duties.**

Mister/Madam Department President, have all the Officers been elected or appointed for the ensuing year?

Department President: **They have.**

Installing Officer: **Mister/Madam Department President, have the books of the Department Treasurer been audited and a report made of same?**

Department President: **They have.**

Installing Officer: **Mister/Madam Department President is the office of Department Treasurer bonded?**

Department President: **It is.**

Installing Officer: **Mister/Madam Department Secretary you will read the names of the Officers for the ensuing year commencing with the Department President. (This includes the immediate Past Department President as a member of the Council of Administration.) As your names are read, you will please rise.**

Mister/Madam Installing Conductor and Assistant Conductor, you will escort the Officers to the Altar.

(See Diagram, page 70)

Installing Conductor: **Mister/Madam Installing Officer all Officers are in position to receive the obligation.**

After Officers are in position, Installing Officer may take position in front of the Altar or may remain at podium.

Installing Officer: **Department Officers, you have been chosen to fill important offices in this Department and it is necessary that the duties of your office be intelligently and faithfully discharged. Are you willing to assume the duties of the office to which you have been chosen and do you promise to perform the same to the best of your ability?**

Department Officers: **I do.**

Installing Officer: **You will raise your right hand and repeat after me, the Officers' obligation:**

Two (2) raps.

Installing Officer: In the presence of the members — of this organization here assembled — I do solemnly promise — on my sacred honor — to perform faithfully, strictly and impartially — all the duties of the office — upon which I am about to enter — I will at the end of my term of office — or sooner if so ordered by proper authority — surrender immediately — to only duly authorized person or persons — all records, money or other properties of this organization — in my possession or under my control. I do so promise.

Let us pray.

Dear God, may we feel Thy nearness, as we bow our heads and ask Thy blessing upon those who have assumed office in this great organization. Make them conscious of the responsibilities they have assumed. Give them courage, strength and a will to forego personal ambitions and strive only to serve others. Guide and direct our hearts and minds so that we may better serve Thee and the Veterans of Foreign Wars. Amen.

If the Installing Officer is at the Altar, they will return to their station.

Three (3) raps.

Installing Officer: Mister/Madam Installing Conductor you will escort the President to this station.

Mister/Madam Installing Conductor and Assistant Conductor, you will escort the Officers to their respective stations beginning with the Senior Vice-President and Junior Vice-President. All newly installed Officers will be seated.

Installing Conductor: Mister/Madam Installing Officer the Officers are at their respective stations.

Installing Officer: Thank you, Mister/Madam Installing Conductor-and Assistant Conductor. Please return to your stations.

Installing Officer: Mister/Madam President you have been elected to the highest office in this Department. Many responsibilities will rest on you. It shall be your duty to have charge of the Charter and other properties of this Department.

To exact obedience to the laws of the National Organization and the Bylaws of this Department.

To pay due respect to all National and Department Officers.

As Department President, it shall be your duty to preside at all sessions of the Convention; to appoint all Officers and Committees not otherwise provided for.

To have general supervision over the Officers of this Department and to see that the Officers perform their respective duties in a proper manner.

To be firm in the discharge of your duties, but strive to promote harmony in the organization and advance its interests by being kind and courteous to all Officers and members.

The Bylaws and Ritual of our organization prescribe in detail the duties of your office. By virtue of your election we are confident that you will acquaint yourself thoroughly with your duties.

Learn well the responsibilities entrusted to you that you may intelligently discharge your duties.

Are you ready to assume your obligation?

President: I am.

Installing Officer: I now present you with this gavel, your emblem of authority, use it firmly but with discretion, and remember the President is expected to set a good example. The success of this Department for the coming year depends in a great measure upon your wise conduct of its affairs. Brothers and Sisters of the Auxiliary, I now present to you the Officers of your choice. Aid them in the performance of their duties and with the Officers you have chosen, this term of office will be highly successful. I wish to extend the best wishes of the National Organization for the success of the Department of _____, Veterans of Foreign Wars of the United States Auxiliary. I now declare the Officers duly installed for the term to which they have been elected or appointed and this Department in good working order.

One (1) rap.

- | | |
|--------------------------------|-----------------|
| Front of Meeting Room | |
| President's Station | |
| ALTAR | |
| President | |
| Jr. Vice | Sr. Vice |
| Secretary | Treasurer |
| Conductor | Chaplain |
| Guard | Chief of Staff |
| Jr. Past D.P. | Dist. Pres. 1 |
| Dist. Pres. 2 | Dist. Pres. 3 |
| Dist. Pres. 4 | Dist. Pres. 5 |
| Dist. Pres. 6 | Dist. Pres. 7 |
| Historian | Patriotic Inst. |
| C.B. #1 | C.B. #2 |
| C.B. #3 | C.B. #4 |
| Flag Bearer | Banner Bearer |
| Musician | Soloist |
| Asst. Guard | Asst. Conductor |
| Asst. Musician | Asst. Soloist |
| POW/MIA Flag Bearer (optional) | |

(Deputy Chief(s) of Staff may be installed on Department Level)

The above would be the lineup for the Department Installation of Officers. You would continue alternating the District Presidents, if you have more to be installed.

INSTALLATION OF NATIONAL OFFICERS

INSTALLATION OF NATIONAL OFFICERS

National President: **The Installing Officer detailed by the Commander-in-Chief to install the National Officers is present. Mister/Madam National Conductor, you will escort the Installing Officer to this station.**

Two (2) raps.

National President: **I have the honor of presenting _____, who has been chosen to install the National Officers. As a member of the Veterans of Foreign Wars of the United States (Auxiliary), we extend to you, a cordial welcome. I have the honor to turn over to you, the command of this organization.**

Installing Officer takes position of presiding Officer; the National President steps to the left.

Three (3) raps.

Installing Officer: **The purpose of my presence here being fully understood, we will proceed at once with our duties.**

By authority of the Commander-in-Chief, I am deputized to install the National Officers of the Veterans of Foreign Wars of the United States Auxiliary.

Installing Officer: **Mister/Madam National President, have all the Officers been duly elected or appointed for the ensuing year?**

National President: **They have.**

Installing Officer: **Have the Bylaws been complied with?**

National President: **They have.**

Installing Officer: **Mister/Madam President, have the books of the National Treasurer been audited and a report made of same?**

National President: **They have.**

Installing Officer: **Mister/Madam National Secretary you will read the names of the Officers for the ensuing year. (This includes the immediate Past National President and new members of the Council.) As the names are read, the Installing Team will escort them to their places at the rear of the Altar.**

*Installing Officer stays at the podium for use of microphone
President-Elect is installed later. They, however, will take the
National Officers' oath at the Altar.*

Installing Officer: **National Officers you have been chosen to fill important offices in the organization and it is necessary that the duties of your position be intelligently and faithfully discharged. Are you willing to assume the duties of the office to which you have been chosen and do you promise to perform the same to the best of your ability?**

National Officers: **I do.**

Two (2) raps.

Installing Officer: **You will raise your right hand and repeat after me, the Officers' obligation:**

In presence of the members—of this organization here assembled—I do solemnly promise on my sacred honor—to perform faithfully, strictly and impartially—all the duties of the office—upon which I am about to enter. I will at the end of my term of office—or sooner if so ordered by proper authority—surrender immediately to only duly authorized person or persons—all records—money or other properties of this organization—in my possession or under my control. I do so promise.

Let us pray.

Dear God, may we feel Thy nearness as we bow our heads and ask Thy blessing upon those who have assumed office in this great organization. Make them conscious of the responsibilities they have assumed. Give them courage, strength and a will to forego personal ambitions and strive only to serve others. Guide and direct their hearts and minds so that they may better serve Thee and the Veterans of Foreign Wars Auxiliary. Amen.

Three (3) raps.

Installing Officer: The Installing Team will escort the President to this station.

Installing Officer: The Installing Team will escort the Officers to their respective stations. Officers will be seated.

Installing Officer: Mister/Madam President you have been elected to the highest office in this organization and many responsibilities will rest on you, but the fact that you have been elected by this convention indicates that they have confidence in your ability and integrity and they feel assured you will strictly and impartially discharge all duties incumbent upon you. As National President, it shall be your duty:

To appoint all Officers and Committees not otherwise provided for, and to see that the Officers of this organization perform their respective duties in a proper manner.

As President, you will be regarded by your Brothers and Sisters and by the general public as a wise and vigorous leader of the Veterans of Foreign Wars of the United States Auxiliary. May all your efforts bring credit to your administration and to our organization. You will be required to devote all necessary time to the many duties of your office. You are expected to make a special study of the National Bylaws and Ritual of this organization so that you may render firm and impartial decisions on important questions referred to you.

To be firm in the discharge of your duties, but strive to promote harmony by being kind and courteous to all Officers and members. National President _____, are you willing and ready to assume your solemn obligation?

National President: **I am.**

Two (2) raps.

Installing Officer: **You will raise your right hand, give your name as I touch your hand and repeat after me:**

President's Obligation: **In the presence of Almighty God—the Officers and Delegates of this organization here assembled—I, _____, do hereby solemnly promise—that I will faithfully discharge to the best of my ability—the duties of the office of National President—of the Veterans of Foreign Wars of the United States Auxiliary—to which I have been elected in accordance with the National Bylaws and Ritual. I solemnly promise—that I will be fair and impartial—in my actions toward all Brothers and Sisters—I will strive to promote the best interest of the Veterans of Foreign Wars of the United States Auxiliary—So help me God.**

Three (3) raps.

Installing Officer: **I now present you with this gavel, your emblem of authority; use it firmly but with discretion, and remember the President is expected to set a good example. The success of this organization for the ensuing year depends in a great measure upon your wise conduct of its affairs. The Officers will please rise.**

Brothers and Sisters of the Auxiliary, I now present to you the Officers of your choice and commend all to cherish the principles upon which this organization was founded.

With the Officers you have chosen, I trust these principles will be carried out.

Mister/Madam National President, National Officers and Delegates, by virtue of the power vested in me, I declare the National Officers of the Veterans of Foreign Wars of the United States Auxiliary, duly installed for the term to which they have been elected or appointed, and this organization in working order for the ensuing year.

One (1) rap.

SPECIAL CEREMONIES

MEMBER INITIATION

(It is strongly recommended that this part of the Ritual is done.
Floor work is optional.)

President: **Mister/Madam Guard, are there any candidates to be admitted?**

Guard: **Yes, Mister/Madam President, we have** (give name(s) of candidate(s)).

President: **Mister/Madam Secretary, have the candidate(s) been duly proposed and elected?**

Secretary: **They have.**

President: **Mister/Madam Treasurer, have all dues been paid?**

Treasurer: **They have.**

President: **Mister/Madam Conductor, retire with the Colors and escort the candidate** (or candidates) **into the room.**

Two (2) raps.

Guard: **Mister/Madam President, the Conductor with the candidate** (or candidates).

President: **You will admit them.**

(See Floor Plan 7)

When the Guard opens the door, Color Bearers 1 and 2 lead, followed by the Conductor and candidate(s) and Color Bearers 3 and 4, marching double file to position in front of Senior Vice-President's station, turn and advance to the rear of the Altar. Upon reaching the Altar, Color Bearers 1 and 2 separate, left and right. The Conductor and candidate(s) take position in rear of the Altar with the Conductor to the left of the candidate(s). Color Bearers 3 and 4 then step to position beside Color Bearers 1 and 2, all facing the President.

Conductor: **Mister/Madam President, I present (name of candidate(s)), who has been voted into membership in this Auxiliary and now awaits your instructions.**

President: **We, the members of the Veterans of Foreign Wars Auxiliary have formed ourselves into a permanent organization for the relief of those who fought in defense of our country and those depending upon them, who may need our aid. Each member is expected to respond to any call for relief or assistance of any member of the Auxiliary or any member of the Post who may be in need. We also endeavor to educate in patriotism, the people of our land. You are to be received into this Auxiliary with equal rights of all other members and you are expected to assume equal responsibilities. Understanding this much of the purpose of our organization, are you ready to take the obligation?**

Candidate: **I am.**

President: **I now commend you to the care of the Chaplain who will administer to you the obligation of our organization. Color Bearers, Altar position.**

The Color Bearers assume Altar position at the command of the President (the same as for opening prayer) and remain in this position during the obligation and prayer.

The Chaplain advances directly from their station to a position in front of the Altar facing the candidate(s) to administer the obligation. They shall raise their right hand also while giving the obligation. The President may ask the members to join in with the candidate(s) in taking the obligation.

Chaplain: **You will raise your right hand, using your name where I use mine and repeat after me:**

MEMBER OBLIGATION

Candidate: **In the presence of Almighty God— and the members of this organization here assembled— I, _____, do of my own free will and accord—, solemnly promise—that I will never wrong or defraud this organization— nor a member thereof— nor permit either to be wronged— if in my power to prevent it.**

I will never propose for membership— any person not eligible—according to our Bylaws.

I further state that I believe in God. I will be faithful to the United States of America—obedient to the laws— and loyal to the Flag.

Should my membership with this organization cease in any way— I will consider this obligation—as binding outside of the organization— as though I had remained a member— I do so promise.

President: **Parade Rest!**

Chaplain: **Dear God, we ask Thy blessing upon these Brothers and Sisters, who have now become members. May our ties foster among us an enduring friendship and loyalty, and grant that henceforth they may be spared for a useful life to the honor and glory of Thy Holy Name. Amen.**

All Respond—Amen.

President: **Attention!**

Conductor: **Color Bearers, right and left face, forward march.** *Chaplain returns to their station.*

President: **Color Bearers, take your stations.**

When Color Bearers are at their stations, three (3) raps.

President: I now commend you to the care of the Senior Vice-President, who will instruct you.

The Senior Vice-President advances to a position in front of the Altar by way of the Junior Vice-President's station, facing candidate(s). They pause until addressed by the President.

President: Mister/Madam Senior Vice-President, I present the candidate (or candidates) for further instruction.

Senior Vice-President: I will now instruct you in the work of our organization. If the Auxiliary is in session, upon approaching the door, you will give a knock. Show your current membership card to the Guard, then be seated.

Should you wish to address the President, or take part in any debate, you will always rise and receive recognition before speaking. You are not to pass between the Altar and the President, except as the Ritual directs. I now commend you to the care of the Junior Vice-President.

The Senior Vice-President returns to their station by way of the Chaplain's station and the Junior Vice-President advances directly from their station to a position in front of the Altar, facing the candidate(s), where they pause until addressed by the President.

President: Mister/Madam Junior Vice-President, I present the candidate (or candidates) for your instructions.

Junior Vice-President: As a member of this Auxiliary, we shall expect you to do your share, for ours is a great work, lasting throughout life, for so long as there are veterans, so long will our work continue. To care for the members in distress and for those who depend upon them is part of the work of this organization—and when death shall lay his hand on any Post or Auxiliary member, it is our duty to see that he or she is buried in the proper manner and with the honor due them.

The Junior Vice-President returns to their station, making a right face at the Altar.

Conductor: Mister/Madam President, I present this candidate (or these candidates) for your final instructions.

President: In succession, the Senior and Junior Vice-Presidents have spoken to you of the work in which you are about to engage. We hope that its impression will remain with you throughout life, adding another link to the golden but invisible chain, which unites us. We sincerely trust that your association with us will strengthen you for the duties of life. We wish to stress the importance of the obligation you have taken.

Our organization is founded on patriotism and loyalty. Loyalty to each other will promote loyalty to the work in which we are engaged. We are united, not for self-seeking, but to maintain true allegiance by upholding the principles upon which our organization was founded.

The President will proceed to the Altar, carrying current Bylaws and membership pins, leaving their station on the right, proceeding between Color Bearers 1 and 2. Upon reaching the Altar, they step to the right, handing Conductor the Bylaws and pins, then steps back to the center of the Altar, facing candidate(s) to explain our emblem. The Conductor hands each candidate a copy of the Bylaws and a pin.

President: We explain to you this emblem of our organization, which may be worn by you as long as you remain a member in good standing. May its ground of gold symbolize to you Strength; its lines of white, Purity; its circle of blue, Truth and its cross, Faith. May you be filled with the Spirit of Loyalty, keeping you ever loyal to your God and to the United States of America.

This concludes your instructions and I extend my best wishes for your future in this organization.

President returns to their station.

President: I have the pleasure of introducing a new member (or these new members.) The Auxiliary will recess for a few minutes to enable our Brothers and Sisters to welcome our new member (or members.)

Mister/Madam Chaplain, please close the Bible.

When Chaplain is given the order to close the Bible, they proceed to the Altar as in opening ceremonies; when business is to resume, President gives three (3) raps.

President: Mister/Madam Chaplain, please open the Bible.

AUXILIARY INSTITUTION

The Officer appointed to institute an Auxiliary shall take the chair and call the meeting to order; state the object of their visit and appoint a Secretary, Conductor and Chaplain pro tem.

Officer: By authority of the National President, I am deputized to institute this Auxiliary.

Mister/Madam Secretary, you will call the roll.

As your name is called, you will rise and respond “Here” and the Conductor will place you in position at the Altar.

Two (2) raps.

The Officer will present themselves in front of Altar.

Officer: Ladies and gentlemen, are you ready to become members of the Veterans of Foreign Wars of the United States Auxiliary?

Candidates: I am.

Officer: You will raise your right hand and repeat after me the obligation of our Auxiliary, using your name where I use mine:

OBLIGATION

In the presence of Almighty God— and the members of this organization here assembled— I, _____, do of my own free will and accord, solemnly promise—that I will comply with the Bylaws and Ritual—that I will never wrong or defraud this organization— nor a member thereof— nor permit either to be wronged— if in my power to prevent it.

I will never propose for membership —any person not eligible according to our Bylaws.

I further state that I believe in God. I will be faithful to the United States of America—obedient to the laws— and loyal to the Flag.

Should my membership with this organization cease in any way— I will consider this obligation—as binding outside of the organization— as though I had remained a member— I do so promise.

Let us pray.

Officer: Dear God, we ask Thy presence and blessings upon this Auxiliary. Hear our prayer and accept the obligation these Brothers and Sisters have taken. May our ties foster among us an endearing friendship and loyalty and grant that henceforth they may be spared for a useful life and enable them to honor all Brothers, Sisters and Comrades in Thy Holy Name. Amen.

Installing Officer returns to podium.

Three (3) raps.

Officer: Having complied with all that our rules and regulations require, it gives me great pleasure to welcome you as members of the Veterans of Foreign Wars Auxiliary. I, therefore, declare _____ Auxiliary to Post No. _____ Veterans of Foreign Wars of the United States, to be duly instituted, and while complying with the Bylaws and Booklet of Instructions, fully entitled to all its benefits and privileges.

One (1) rap.

Officer: Mister/Madam Conductor, escort the members to their seats.

DISTRICTS

The District is chartered by National and has legislative and limited taxing power. Its purpose is to promote schools of instruction and to insure functioning Auxiliaries within the confines of the District through instruction and inspection.

The District President is a Department Officer and a member of the Department Council of Administration.

FORM FOR INSTITUTING DISTRICTS

The Officer appointed to institute a District shall take the chair and call the meeting to order; state the object of their visit; and appoint a Secretary, Chaplain and Conductor pro tem.

Officer: By authority of the National President, I am deputized to institute this District.

Mister/Madam Secretary pro tem, have all necessary fees been paid?

Secretary Pro Tem: They have (or if all Auxiliaries have not paid fees, names and numbers of said Auxiliaries should be stated).

Officer: Mister/Madam Secretary, you will call the names of the Auxiliaries. *As the names of the Auxiliaries are called, the President or one of the Delegates should rise and respond "here."*

Officer: Mister/Madam Presidents, have your Auxiliaries voted to become a part of this District and do they pledge themselves to comply with all the rules and regulations governing this District as found in the Bylaws of the Veterans of Foreign Wars of the United States Auxiliary?

Response: They do.

Officer: **The Chaplain will offer the prayer.**

Chaplain: **Dear God, we beseech Thy presence and blessings upon this District. Hear our prayer and accept the pledge these Brothers and Sisters have taken. May our ties foster among us an enduring friendship and loyalty and grant that henceforth they may be spared for a useful life and enable them to honor all Brothers, Sisters and Comrades in Thy Holy Name. Amen.**

Officer: **Having complied with all that our rules and regulations require, it gives me great pleasure to welcome this District into our National Organization. I, therefore, declare the _____ (name) District of the Veterans of Foreign Wars of the United States Auxiliary to be duly instituted, and while obeying the rules and regulations of the organization, fully entitled to all its benefits and privileges.**

Instituting Officer will then see that the election of District Officers takes place, after which they will install them in office.

If selection of Officers has been made prior to the Institution, the Instituting Officer will see that this selection of Officers is ratified immediately following the institution.

With the new District Officers in their respective chairs, it is now the duty of the Instituting Officer to assist the new District in conducting business and to help them in whatever way is necessary.

After performing above duties to the satisfaction of the District organized, the Instituting Officer shall report same to the National and Department Secretaries with the names and addresses of the Officers.

FORM FOR INSTITUTING DEPARTMENTS

The Officer appointed to institute a Department shall take the chair and call the meeting to order, state the object of their visit, and appoint a Secretary, Chaplain, and Conductor pro tem.

Officer: By authority of the National President, I am deputized to institute this Department.

Mister/Madam Secretary Pro Tem, have all necessary fees been paid?

Secretary Pro Tem: They have. Or if all Auxiliaries have not paid fees, names and numbers of said Auxiliaries should be stated.

Officer: Mister/Madam Secretary, you will call the names and numbers of the Auxiliaries. As the names and numbers of the Auxiliaries are called, the President or one of the Delegates should rise and respond "here."

Officer: Mister/Madam Presidents, do your Auxiliaries pledge themselves to comply with all the rules and regulations governing this Department as found in the Bylaws of the Veterans of Foreign Wars of the United States Auxiliary?

Response: They do.

Officer: The Chaplain will offer the prayer.

Chaplain: Dear God, we beseech Thy presence and blessings upon this Department. Hear our prayer and accept the pledge these Brothers and Sisters have taken. May our ties foster among us an enduring friendship and loyalty and grant that henceforth they may be spared for a useful life and enable them to honor all Brothers, Sisters and Comrades in Thy Holy Name. Amen.

Officer: Having complied with our rules and regulations, it gives me great pleasure to welcome this Department into our National Organization. I, therefore, declare the Department of _____ (name) Veterans of Foreign Wars of the United States Auxiliary to be duly instituted, and while obeying the rules and regulations of our organization, fully entitled to all its benefits and privileges.

Instituting Officer will then see that the election of Department Officers takes place, after which they will install them into office.

If selection of Officers has been made prior to the Institution, the Instituting Officer will see that this selection is ratified after the institution.

With the new Department Officers in their respective chairs, it is now the duty of the Instituting Officer to assist the new Department in conducting the business and to help them in whatever way is necessary.

After performing above duties to the satisfaction of the Department organized, the Instituting Officer shall report same to the National Secretary with the names and addresses of the Officers.

Prior to instituting a Department each Auxiliary in said Department should turn to Article III, and elect Delegates and Alternates from their Auxiliary to attend the instituting of the Department and represent the Auxiliary at the Department meeting which generally follows immediately after the Department Officers have been duly installed.

Installation of Officers will follow. If Officers have not been elected, a meeting shall be called to elect Officers. If Officers have been elected, ratification of Officers is necessary.

CONTEMPORARY MEMORIAL SERVICE

(All floor work for Color Bearers is optional for this service. The President may select songs other than those listed in the Ritual.)

DRAPING OF THE CHARTER

Charter should be placed in front of the President's station before meeting starts.

President: **Mister/Madam Conductor, you will retire with the Colors for the draping of the Charter.**

Two (2) raps.

Conductor and Color Bearers go to the Altar.

Conductor: **About face.**

All retire, double file, led by Color Bearers 3 and 4, followed by the Conductor and Color Bearers 1 and 2. Entering with Charter Drape.

(See Floor Plan 8)

Solemn music should be played during the service, beginning when the Conductor enters the room with the drape. The Color team should walk reverently, but without hesitation.

Color Bearers 1 and 2 lead, double file, Conductor in center carrying black drape in both hands, followed by Color Bearers 3 and 4, double file, proceed directly to the Charter, going past the Chaplain's station. As the Conductor and Color Bearers pass the Chaplain's station, the Chaplain approaches the Altar via the same route as for opening prayer and remains in position at Altar while the Charter is draped and the Chaplain prays.

When Officers are in position, in front of Charter, all right face, forming a straight line facing the President. As the Conductor gives charge, they place the drape on the Charter.

Conductor: It is my solemn duty to drape our Charter in memory of our beloved Brother/Sister _____.

Conductor steps back into position in line with the Color Bearers and all remain in this position during the prayer.

President: Parade rest.

Chaplain: Let us pray. We are humbled by the loss of a member who served from the heart for this organization and for veterans. We come together to remember those deeds of goodness, kindness, love and charity. May we use our memories as a guiding light so that we may follow this example set before us. Amen.

When the Chaplain has finished the prayer, they remain at the Altar, while the Conductor and Color Bearers left face, return to double file and proceed to the rear of the Altar, passing the Junior Vice-President's station; turn left to front of Senior Vice-President's station; then make left turn—marching forward to the Altar where the Color Bearers separate—left and right, and all stand in a straight line facing the President.

If the Memorial Service follows the draping of the Charter, the Officers will remain at the Altar until instructed to prepare the Altar for Memorial Services. If Memorial Services do not follow, President will give instructions.

President: Officers, take your stations.

Three (3) raps.

Note: Drape will remain for thirty (30) days for an Auxiliary. Drape shall remain on Charter until the close of the convention for District, Department and National.

MEMORIAL SERVICE

(Floor work optional.)

(See Floor Plans 9 to 10B)

Special vocal or instrumental music may be added to this service if desired.

Special effects may also be used.

Solemn music should be played and Officers should march reverently but without hesitation during this service.

During Memorial Service NO RAPS are used.

If Memorial Service follows the draping of the Charter, President instructs:

President: **Mister/Madam Conductor and Chaplain, prepare the Altar for the Memorial Service.**

If the Charter is not draped, the President instructs:

President: **Mister/Madam Conductor and Chaplain, with the Colors, prepare the Altar for the Memorial Service.**

Following the charge of the President, the Chaplain lifts the Bible and reverently closes it. The Conductor folds the Altar cloth. (Pick up Altar cloth by top—right and left corners; fold to back—right corner to left corner—repeat this procedure. Fold in one-half (1/2), bottom to top—with Auxiliary emblem up.)

Chaplain hands Bible to Conductor who carries Bible and Altar cloth to the anteroom. (Bible to be placed on the folded Altar cloth). All about face and march—double file—to the Senior Vice-President's station where they turn. Chaplain returns to their station as Conductor and Color Bearers proceed to the anteroom.

DRAPING THE ALTAR

Color Bearers leave their Flags in the anteroom and obtain the Memorial Altar cloth. Each Color Bearer holds a corner of the Memorial Altar cloth, keeping far enough apart to hold the cloth flat and taut with hand close to body.

Color Bearers enter holding Memorial Altar cloth, led by Color Bearers 3 and 4, followed by the Conductor, who carries the open Bible. When in front of the Senior Vice-President's station, they proceed directly to the Altar. Color Bearers pass to each side of the Altar and as the Conductor reaches the Altar, they face the Altar, as in opening ceremonies, (Altar position) and very slowly lower the cloth onto the Altar. The Conductor places the Bible on the Altar and steps back one (1) step.

Color Bearers 1 and 3 turn right, Color Bearers 2 and 4 turn left and proceed to the rear of the Altar. As Color Bearers 1 and 2 are in line with the Conductor, the Conductor makes an about face and all proceed directly to their stations. All about face and President motions Officers and members to be seated.

President: Brothers and Sisters of this Auxiliary and friends, we have met at this time to honor the memory of our Brothers and Sisters, who have departed from this world to the realities of another. The Conductor will see that there is no disturbance during the ceremony.

Conductor: Mister/Madam President, your orders will be obeyed.

President: I will request the Chaplain to preside during this solemn service.

Chaplain: I am at your service and will endeavor to perform this solemn duty in the spirit of faith, hope and charity.

After they respond, the Chaplain proceeds directly from their station to that of the President. The President steps to the right; the Chaplain assumes the President's station.

Chaplain: **Brothers, Sisters and friends, you will join with me in singing one (1) verse of "Abide With Me."** *Chaplain motions audience to rise.*

**Abide with me;
Fast falls the even-tide;
The darkness deepens;
Lord with me abide;
When other helpers fail
and comforts flee,
Help of the helpless,
O' Abide with me.**

Chaplain: **Let us pray. During this time of remembrance, let each of us think of the wonderful legacy left by our departed members. May we find the strength to carry on our mission of serving veterans and their families in the same spirit of kindness and love. Amen.** *Chaplain seats the audience.*

Chaplain: **Mister/Madam President, what tribute have you to offer at this time?**

The President steps from the podium to their right and proceeds behind the Secretary's station, making a left turn. They step past the Conductor making a left turn and proceed just beyond Color Bearer 1, making a right turn and goes past the Altar. They turn left to a position behind the Altar and faces the President's station when placing flowers around the Bible.

(See Floor Plan 10B)

President: **These white flowers I bring as a token of the love that we have for our departed Brothers and Sisters.**

Chaplain: **Mister/Madam Secretary, you will call the roll of deceased members.**

As the Secretary calls the names of the deceased members, the President places a flower around the Bible for each name called. (At a Department Convention, each District will be called with number of deceased members, or as the Department directs.) When this is completed, the President returns to their position at the right of the Chaplain in the same manner as they approached the Altar.

If Memorial Address is given, special music may be played or sung.

Chaplain: **Memorial Address will be given at this time.**

At this time, the soloist may sing a song. The President may choose the song.

Chaplain motions audience to rise.

Chaplain: **Mister/Madam Conductor, you will rearrange the Altar.**

(See Floor Plans 11-12)

When directed by the Chaplain to rearrange the Altar, the Conductor and Color Bearers proceed to the Altar in the usual manner. The Conductor reverently removes the Bible. The Color Bearers step forward, led by Color Bearers 3 and 4, followed by Color Bearers 1 and 2; face the Altar and each pick up one (1) corner of the Memorial cloth, leaving the flowers on the cloth. Color Bearers face the rear of the room, proceed toward the Senior Vice-President's station with the Memorial Altar cloth, led by the Conductor carrying the open Bible. When in front of the Senior Vice-President's station, they turn and proceed to the anteroom.

Chaplain motions audience to be seated when Conductor/ Conductress and Color Bearers reach the anteroom. After the Conductor and Color Bearers reach the anteroom, the Chaplain returns to their station.

Guard: **Mister/Madam President, the Conductor-with the Colors.**

President: **You will admit them.**

Two (2) raps.

(See Floor Plan 13)

Regular music is played as Color Bearers and Conductor re-enter the room, led by Color Bearers 1 and 2, followed by Conductor carrying Bible and Altar cloth and Color Bearers 3 and 4. Chaplain joins Conductor in line at the Senior Vice-President's station and all proceed to rear of Altar, double file. Color Bearers separate left and right and all form a straight line at the back of the Altar.

Conductor gives Bible to Chaplain, who holds same while the Conductor places the Altar cloth on Altar, then the Chaplain opens the Bible and lays it in the center of the Altar.

President: **Officers take your stations.**

Three (3) raps.

TRADITIONAL MEMORIAL SERVICE

DRAPING OF THE CHARTER

(See Floor Plan 8)

Charter should be placed in front of the President's station before meeting starts.

The President may select songs other than those listed in the Ritual.

President: **Mister/Madam Conductor, you will retire with the Colors for the draping of the Charter.**

Two (2) raps.

Conductor and Color Bearers go to the Altar.

Conductor: **About face.**

All retire, double file, led by Color Bearers 3 and 4, followed by the Conductor and Color Bearers 1 and 2.

Entering with Charter Drape

(See Floor Plan 8)

Sacred music should be played during the service, beginning when the Conductress enters the room with the drape. The Color team should walk reverently, but without hesitation.

Color Bearers 1 and 2 lead, double file, Conductor in center carrying black drape in both hands, followed by Color Bearers 3 and 4, double file, proceed directly to the Charter, going past the Chaplain's station. As the Conductor and Color Bearers pass the Chaplain's station, the Chaplain approaches the Altar via the same route as for opening prayer and remains in position at Altar while the Charter is draped and the Auxiliary sings, "Nearer My God to Thee."

When Officers are in position, in front of Charter, all right face, forming a straight line facing the President. As the Conductor gives charge, they place the drape on the Charter.

Conductor: It is my solemn duty to drape our Charter in memory of our beloved Brother/Sister _____ who went to their Heavenly home on _____.

Conductor steps back into position in line with the Color Bearers and all remain in this position during the song and prayer.

President: We will sing one (1) verse of “Nearer My God to Thee.”

**Nearer My God to Thee;
Nearer to Thee,
E'en though it be a cross
That raiseth me,
Still all my song shall be
Nearer my God to Thee;
Nearer my God to Thee;
Nearer to Thee.**

President: Parade rest.

Chaplain: Our Heavenly Father, who art our refuge and strength in our time of trouble, enable us we pray, to put our trust in Thee. May we come boldly unto Thy Throne, that we may obtain mercy and find grace to help in the time of need. Amen.

When the Chaplain has finished the prayer, they remain at the Altar, while the Conductor and Color Bearers left face, return to double file and proceed to the rear of the Altar, passing the Junior Vice-President's station; turn left to front of Senior Vice-President's station; then make left turn—marching forward to the Altar where the Color Bearers separate—left and right, and all stand in a straight line facing the President.

If the Memorial Service follows the draping of the Charter, the Officers will remain at the Altar until instructed to prepare the Altar for Memorial Services.

If Memorial Services do not follow, President will give instructions.

President: **Officers, take your stations.**

Three (3) raps.

NOTE: Drape shall remain on Charter until the close of the convention. (National and Department)

MEMORIAL SERVICE

(See Floor Plans 9 to 10B)

Special vocal or instrumental music may be added to this service if desired. Special effects may also be used.

Sacred music should be played and Officers should march reverently—but without hesitation, during this service.

During Memorial Service—NO RAPS are used.

If Memorial Service follows the draping of the Charter, President instructs:

President: **Mister/Madam Conductor and Chaplain, prepare the Altar for the Memorial Service.**

If the Charter is not draped, the President instructs:

President: **Mister/Madam Conductor and Chaplain, with the Colors, prepare the Altar for the Memorial Service.**

Following the charge of the President, the Chaplain lifts the Bible and reverently closes it. The Conductor folds the Altar cloth. (Pick up Altar cloth by top—right and left corners; fold to back—right corner to left corner—repeat this procedure. Fold in one-half (1/2), bottom to top—with Auxiliary emblem up.)

Chaplain hands Bible to Conductor who carries Bible and Altar cloth to the anteroom. (Bible to be placed on the folded Altar cloth). All about face and march—double file—to the Senior Vice-President’s station where they turn. Chaplain returns to their station as Conductor and Color Bearers proceed to the anteroom.

DRAPING THE ALTAR

Color Bearers leave their Flags in the anteroom and obtain the Memorial Altar cloth. Each Color Bearer holds a corner of the Memorial Altar cloth, keeping far enough apart to hold the cloth flat and taut with hand close to body.

Color Bearers enter holding Memorial Altar cloth, led by Color Bearers 3 and 4, followed by the Conductor, who carries the open Bible. When in front of the Senior Vice-President’s station, they proceed directly to the Altar. Color Bearers pass to each side of the Altar and as the Conductor reaches the Altar, they face the Altar, as in opening ceremonies, (Altar position) and very slowly lower the cloth onto the Altar. The Conductor places the Bible on the Altar and steps back one (1) step.

Color Bearers 1 and 3 turn right, Color Bearers 2 and 4 turn left and proceed to the rear of the Altar. As Color Bearers 1 and 2 are in line with the Conductor, the Conductor makes an about face and all proceed directly to their stations. All about face and President motions Officers and members to be seated.

President: Brothers and Sisters of this Auxiliary and friends, we have met at this time to honor the memory of our Brothers and Sisters, who have departed from this world to the realities of another. The Conductor will see that there is no disturbance during the ceremony.

Conductor: Mister/Madam President, your orders will be obeyed.

President: I will request the Chaplain to preside during this solemn service.

Chaplain: **I am at your service and will endeavor to perform this solemn duty in the spirit of faith, hope and charity.**

After they respond, the Chaplain proceeds directly from their station to that of the President. The President steps to the right; the Chaplain assumes the President's station.

Chaplain: **Brothers, Sisters and friends, you will join with me in singing one (1) verse of "Abide With Me."** *Chaplain motions audience to rise.*

**Abide with me;
Fast falls the even-tide;
The darkness deepens;
Lord with me abide;
When other helpers fail
and comforts flee,
Help of the helpless,
O' Abide with me.**

Chaplain seats the audience.

Chaplain: **Mister/Madam President, what message have you for us at this time?**

President: *(Stand)* **I have a message of hope, that should inspire our Brothers and Sisters at this solemn moment and all through life. The message is from our God, who says: I am the Resurrection and the Life; he that believeth in Me, though he were dead, yet shall he live, and whosoever liveth and believeth in Me shall never die.**

Chaplain: **Mister/Madam Senior Vice-President, what assurance have we of a prolonged stay among the scenes and activities of this earth?**

Senior Vice-President: *(Stand)* **For we are strangers before Thee and sojourners as were all our Fathers; our days on earth are as a shadow and there is no abiding.**

Chaplain: Mister/Madam Junior Vice-President, have you a message of sympathy for those who sorrow?

Junior Vice-President: *(Stand)* I have. The Book of Life tells us that, like as a father pitieth his children, so the Lord pitieth them that fear Him for He knoweth our frame, He remembereth that we are dust.

Chaplain: Brothers and Sisters, we should be thankful for these inspiring thoughts. Let us learn the lesson of the hour, which is, that we, too, are nearing the end of life's pilgrimage and sooner or later these services may be held in our memory. Let us so live that when our summons comes, we may depart with the testimony of a good conscience in the comfort of a reasonable religion, with perfect charity for all mankind and a holy hope in the favor of God.

Chaplain motions audience to rise.

Let us pray.

Our Father in Heaven, at this time of remembrance, we seek Thee with whom there is no death. We beseech Thee in Thy everlasting charity to look down on these, Thy servants, and give them health, strength and willingness to carry on the work of our beloved organization, which shall be an everlasting memorial to those Brothers and Sisters who have passed on, and in Thy great infinite wisdom and mercy, may we all meet again and to Thy name shall be praise now and forever. Amen.

Chaplain seats the audience.

Chaplain: Mister/Madam President, what tribute have you to offer at this time?

The President steps from the podium to their right and proceeds behind the Secretary's station, making a left turn. They step past the Conductor making a left turn and proceeds just beyond Color Bearer 1, making a right turn and goes past the Altar. They turn left to a position behind the Altar and faces the President's station when placing flowers around the Bible.

(See Floor Plan 10B)

President: These white flowers I bring as a token of the love that we have for our departed Brothers and Sisters.

Chaplain: Mister/Madam Secretary, you will call the roll of deceased members.

As the Secretary calls the names of the deceased members, the President places a flower around the Bible for each name called. (At a Department Convention, each District will be called with number of deceased members, or as the Department directs.) When this is completed, the President returns to their position at the right of the Chaplain in the same manner as they approached the Altar.

If Memorial Address is given, special music may be played or sung.

Chaplain: Memorial Address will be given at this time.

Chaplain motions audience to rise.

Chaplain: All join in singing one (1) verse of “Blest Be The Tie That Binds.”

**Blest be the tie that binds
Our Hearts in Christian love;
The fellowship of kindred minds
Is like to that above.**

May the blessings of God the Father be with you now and forever. Amen.

Chaplain: Mister/Madam Conductor, you will rearrange the Altar.

(See Floor Plans 11-12)

When directed by the Chaplain to rearrange the Altar, the Conductor and Color Bearers proceed to the Altar in the usual manner. The Conductor reverently removes the Bible. The Color Bearers step forward, led by Color Bearers 3 and 4, followed by Color Bearers 1 and 2; face the Altar and each pick up one (1)

corner of the Memorial cloth, leaving the flowers on the cloth. Color Bearers face the rear of the room, proceed toward the Senior Vice-President's station with the Memorial Altar cloth, led by the Conductor carrying the open Bible. When in front of the Senior Vice-President's station, they turn and proceed to the anteroom.

Chaplain motions audience to be seated when Conductor and Color Bearers reach the anteroom. After the Conductor and Color Bearers reach the anteroom, the Chaplain returns to their station.

Guard: Mister/Madam President, the Conductor with the Colors.

President: You will admit them.

Two (2) raps.

(See Floor Plan 13)

Regular music is played as Color Bearers and Conductor re-enter the room, led by Color Bearers 1 and 2, followed by Conductor carrying Bible and Altar cloth and Color Bearers 3 and 4. Chaplain joins Conductor in line at the Senior Vice-President's station and all proceed to rear of Altar, double file. Color Bearers separate left and right and all form a straight line at the back of the Altar.

Conductor gives Bible to Chaplain, who holds same while the Conductor places the Altar cloth on Altar, then the Chaplain opens the Bible and lays it in the center of the Altar.

President: Officers take your stations.

Three (3) raps.

DEDICATION OF THE COLORS

The Dedicating Officer assumes a position at the right side of the President. Other Officers are in their regular stations.

President: **We have the honor to dedicate our Auxiliary Banner and to rededicate ourselves to our National Flag. On this occasion, Brother/Sister _____, who stands beside me, will serve as our Dedicating Officer and direct the ceremony. Brother/Sister _____, you will take command.**

Dedicating Officer: **Mister/Madam President and Brothers and Sisters of _____ Auxiliary to Post No. _____, I bring you heartiest greetings from the Department of _____ (or from the District they represent.) This is a very special moment in the history of your Auxiliary. We shall place officially the Flag of our Country and your new Auxiliary Banner among the ever growing number of Banners in our organization. Mister/Madam Conductor, you will present these Colors.**

The Conductor retires with the Flag Bearer and Banner Bearer. The Flag Bearer and Banner Bearer enter the room carrying the Flag and Banner to be dedicated, led by the Conductor. The Conductor gives the necessary commands throughout the ceremony. They advance directly to the front of the room, forming a line in front of the President's station, facing the assembly. As the Officers pass the station of the Chaplain, they leave their station and assumes a position at the rear of the Altar.

Dedicating Officer: **Brothers and Sisters, we will rededicate ourselves to the Stars and Stripes by saluting our National Flag and repeating the Pledge of Allegiance.**

Dedicating Officer: **Salute!** *Military Salute for veterans*

Pledge of Allegiance to the Flag.

Dedicating Officer: **Before you is the Flag of our Nation** (*speaker indicates the Flag*). **This Flag is the symbol of all that is sacred to us. Look at it closely for a moment. The Flag of the United States reflects what we are and what we hope to be. The white stripes symbolize purity of purpose in our freedom of thought, expression and worship.**

These are the privileges we guarantee to all who live in our land. They are the rights we defend against all enemies who seek to crush the way of life that you and I cherish. Also, in this Flag, we see the red stripes of courage, for the preservation of American ideals.

There is the blue of tranquility upon which the stars of our states are united to hold intact all that is truly ours, the desire for peace, prosperity and happiness throughout our nation.

We emphasize this interpretation of the Flag of our country which you see carried proudly and guarded so carefully, and we ask that you will always respect this Flag. It is a great symbol of our United States of America.

Dedicating Officer: **Mister/Madam Conductor, you will assist me.** *Conductor takes hold of the upper corner of the Banner, holding it out so that the words thereon may be seen.*

Dedicating Officer: **Brothers and Sisters, this is your Auxiliary Banner.** *They read the words on the Banner, after which the Conductor releases the corner they have been holding.*

Dedicating Officer: **Brothers and Sisters, this Banner is to be your official Veterans of Foreign Wars Auxiliary emblem, around which you shall build the strength, character and progress of your Auxiliary. Mister/Madam President and Brothers and Sisters, by authority vested in me by the Veterans of Foreign Wars of the United States Auxiliary, I hereby declare this to be the official Banner of Auxiliary to Post No. _____ .**

Dedicating Officer: **The Chaplain will ask the blessing upon the new Flag and Banner. Parade rest.**

Chaplain: **Dear God, bless our nation's emblem. May it ever symbolize freedom and justice for all men. Bless, too, the Banner of this Auxiliary. Help us to always campaign vigorously for principles that are noble and right—for the high ideals represented by this Flag and Banner. Amen.**

All: **Amen.**

The Colors are now posted.

President: **Officers, take your stations.**

Three (3) raps.

HONORING GOLD STAR PARENTS

(The VFW Ritual)

(Note: The presiding Officer shall announce the following to the audience)

Officer: The Veterans of Foreign Wars Ritual provides that when honoring Gold Star parents, we shall refrain from applauding.

There are times when mere words seem far from being adequate. This is such an occasion because we are gathered to recall persons who have made the supreme sacrifice—and to honor their parents. Thus our deeds speak better than words.

The Veterans of Foreign Wars of the United States is founded upon the true comradeship of persons bound by experiences, interests and everlasting patriotism. It is the sort of comradeship that lives through succeeding generations and far back into memory because we know that neither time nor events can separate those who have joined in the common defense of our Flag and country. That is the way we feel about the persons who are absent. We do not consider them gone. In reality, they are very close to us. They are definitely a part of our thinking and actions. We feel that they have molded the future of our nation. They give us strong incentive to carry on our crusade for lasting peace and better purpose in life.

The highest tribute this organization can render those persons—the most profound respect all of us can demonstrate is to apply to our own lives—the strong faith and undaunted courage which were theirs.

To the parents of those comrades, we pledge the sincere friendship of this Post and its Auxiliary.

SERVICES FOR DECEASED MEMBERS

An Auxiliary may offer to hold Memorial Services for a deceased member by contacting family without waiting for a request from the family. Any part of the service that may conflict with any religious belief may be omitted, or changed.

The President may select songs other than those listed in the Ritual.

Auxiliary members, if possible, should attend the funeral or services of deceased members of both the Auxiliary and the Post.

Suggested service at funeral home or at grave:

The Conductor shall take charge of the service under the direction of the President.

Members should line up before entering room led by President and Conductor followed by Senior Vice-President and Chaplain. President and Conductor at head of casket; Senior Vice-President and Chaplain at the foot of the casket with members forming themselves in a manner most appropriate in the funeral home or at the grave as circumstances permit.

Soloist will open service by singing "Abide With Me," followed by prayer.

President: **The Chaplain will invoke the divine blessing.**

Chaplain: **Our Father in Heaven, we seek Thee with whom there is no death. Open every eye to behold Him who changed the night of death into morning. In the depths of our hearts, we would hear the divine word, "I am the Resurrection and the Life; he that believeth in Me, though he were dead, yet shall he live". We beseech Thee to look in mercy on this bereaved family and in Thine own tenderness, console and comfort them. Through Thy great mercy, may we all meet at last in joy before Thy Throne in Heaven and to Thy name shall be praise forever and ever. Amen.**

President: We gather here, my Brothers and Sisters, to perform the last rites the living may render the dead. That we are born to die is a solemn truth, the fixed law of being. Honor and station have no power to arrest the hand of the destroyer, and youth and age bow alike before Him. How filled with gloom would be this hour were it not for the blessed promise of God of an eternal home with Him. Another one of our members has been taken from us. We shall miss their words of counsel, their watchful care over the interests of our honored heroes, and their devotion to our Auxiliary. Their life has been full of sacrifices and they have gone on to their reward. In honor and reverence, I now place upon their last resting place, this emblem of loyalty and patriotism as a last tribute to their memory.

The President places emblematic casket flag of the Veterans of Foreign Wars Auxiliary on casket, if services are indoors. If services are held at grave, place emblematic Auxiliary Flag on staff in ground at head of grave. Emblematic flag shall remain on the casket or staff.

Senior Vice-President: For as much as it has pleased God to take out of this world the soul of our departed friend, it shows how beautifully true is the comparison of life to this flower, which opens up in the morning, but in the evening, withers away. It is a symbol of purity and a token of love. I place it here (placing white flower upon casket) in loving remembrance of this departed life.

Chaplain gives short descriptive story-history of the service of deceased to the Auxiliary. Soloist will sing "Lead Kindly Light."

Chaplain: Our Heavenly Father, who art our refuge and strength in our time of trouble, enable us we pray, to put our trust in Thee. May we come boldly unto Thy throne that we may obtain mercy and find grace to help in the time of need. Amen.

The President, Senior Vice-President, Chaplain, Conductor and then members proceed reverently to casket, place a white flower and leave funeral home or grave. If minister is to speak, they will go to their seats, Officers first, then members.

MEMORIAL DAY SERVICE

(Excerpts from the VFW Ritual)

This service is to be used only in conjunction with the Veterans of Foreign Wars.

Commander: **Mister/Madam President of the Veterans of Foreign Wars Auxiliary.**

President steps to foot of grave. They hold blue flowers.

Auxiliary President: **On behalf of the Veterans of Foreign Wars of the United States Auxiliary, I place this emblem of eternity. Its color bespeaks life everlasting. Thus do we immortalize the brave deeds of our soldiers, sailors, airmen, and marines, who have given their lives on land, on sea and in the air.**

Places flowers on grave; returns to position.

MEMORIAL SERVICES FOR NATIONAL AND DEPARTMENT CONVENTIONS AND FOR POSTS OF THE VETERANS OF FOREIGN WARS OF THE UNITED STATES AND THEIR AUXILIARIES

(Excerpts from the VFW Ritual)

This service is to be used only in conjunction with the Veterans of Foreign Wars.

VFW Chaplain: **What message has the Chaplain of the Auxiliary?**

Chaplain of the Auxiliary: **I have a message of hope that should inspire our comrades at this solemn moment and all through life. The message is from the Captain of our Salvation. He says, "I am the Resurrection and the Life; he that believeth in Me, though he were dead, yet shall he live; and whosoever liveth and believeth in Me shall never die."**

VFW Chaplain: **Brothers and Sisters of the Auxiliary, will you offer a tribute to the memory of our departed Comrades?**

President of the Auxiliary: **I place upon our sacred shrine, this wreath as a symbol of eternity. Its color bespeaks life everlasting. Thus do we say that the deeds of our soldiers, sailors, airmen and marines on land, on sea and in the air, are immortalized in the hearts of a grateful people.** (*Places evergreen wreath.*)

FORM OF SERVICES TO BE USED ON MEMORIAL DAY AT THE GRAVES, MONUMENTS OR TABLET OF OUR DEPARTED BROTHERS, SISTERS OR COMRADES

(Colors optional)

President stands at head of grave or appropriate spot before monument. Chaplain stands at foot of the grave or appropriate spot before the monument. Color Bearers 1 and 2 stand at left and right of President; Color Bearers 3 and 4 stand at left and right of Chaplain.

President: Color Bearers, Attention!

Chaplain: Comrades of the Post, Brothers and Sisters of the Auxiliary and friends; we are gathered here at this time to pay tribute (to the memory of those who made the supreme sacrifice) or (to the memory of a departed Brother/Sister.) Mister/Madam President, what message and tribute have you to offer at this time?

President: I have a message of hope that should inspire us at this solemn moment and all through life. The message is from our God who says, "I am the Resurrection and the Life; he that believeth in Me, though he were dead, yet shall he live and whosoever liveth and believeth in Me, shall never die." This wreath, I place in loving tribute (to those who proved that greater love hath no man than to lay down his life for his God, his Country and his Flag) or (to the memory of our departed Brother/Sister.)

Chaplain: Let us pray. Our Father in Heaven, amid these monuments of the dead, we ask Thee with whom there is no death, to open every eye to behold Him who changed the night of death into morning. Through Thy great mercy may we all meet at last in joy before Thy throne in Heaven and to Thy name shall be praise forever and ever. Now, may the blessings of God the Father be with each and every one. Amen.

INSTRUCTIONS FOR PLACING GRAVE MARKER OTHER THAN AT TIME OF BURIAL

President stands at head of grave or appropriate spot before the marker. Chaplain stands at foot of the grave or appropriate spot before the marker. Color Bearers 1 and 2 stand at left and right of President; Color Bearers 3 and 4 stand at left and right of Chaplain.

Chaplain: Comrades of the Post, Brothers and Sisters of the Auxiliary and friends;

We are gathered here at this time to pay tribute to the memory of a departed Brother/Sister. Mister/Madam President, what message and tribute have you to offer at this time?

President: I have a message of hope that should inspire us at this solemn moment and all through life. The message is from our God, who says: “I am the Resurrection and the Life; he that believeth in Me, though he were dead, yet shall he live and whosoever liveth and believeth in Me shall never die.” I place this emblem in loving tribute to the memory of our departed Brother/Sister.

Chaplain: Let us pray. Our Heavenly Father, we ask Thee, with whom there is no death, to open every eye to behold Him who changed the night of death into morning. Through Thy great mercy may we all meet at last in joy before Thy throne in Heaven and to Thy name shall be praise forever and ever. Now may the blessings of God the Father be with each and every one. Amen.

If grave marker is to be placed at time of burial, President should place emblematic flag and marker in accordance with service on page 110 in Ritual.

FLOOR PLANS

FLOOR PLAN 1

Showing position of officers during Sessions of Auxiliary

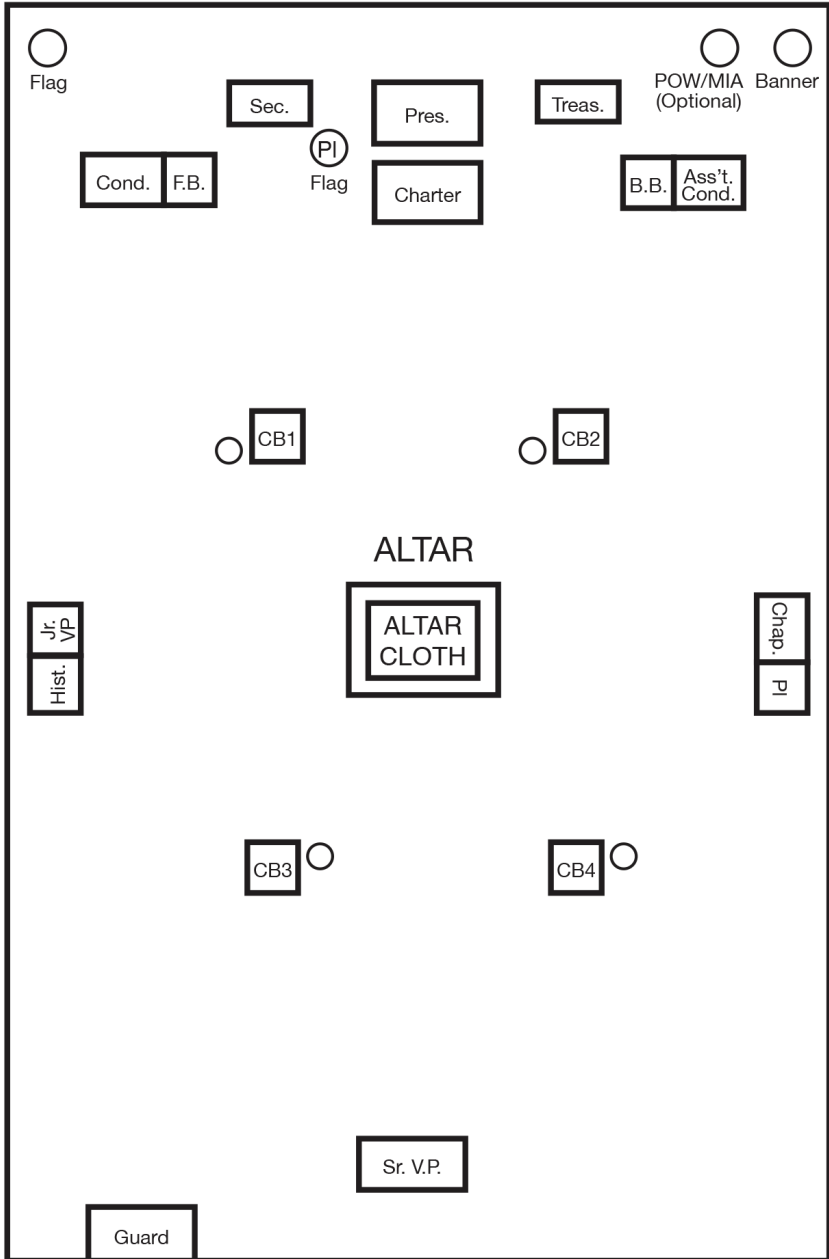

FLOOR PLAN 2

Advancing to Altar for Securing Colors

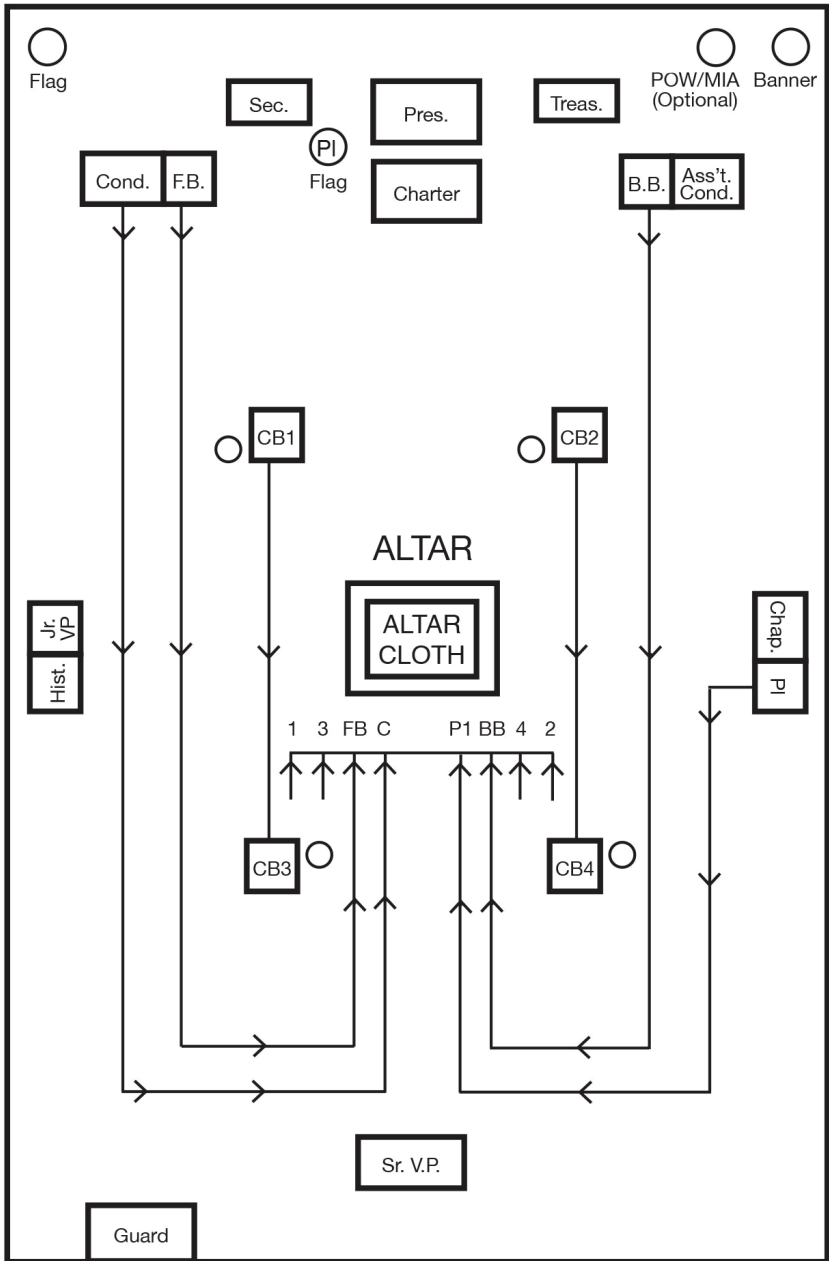

FLOOR PLAN 3

Retiring from Altar to anteroom
showing line of march

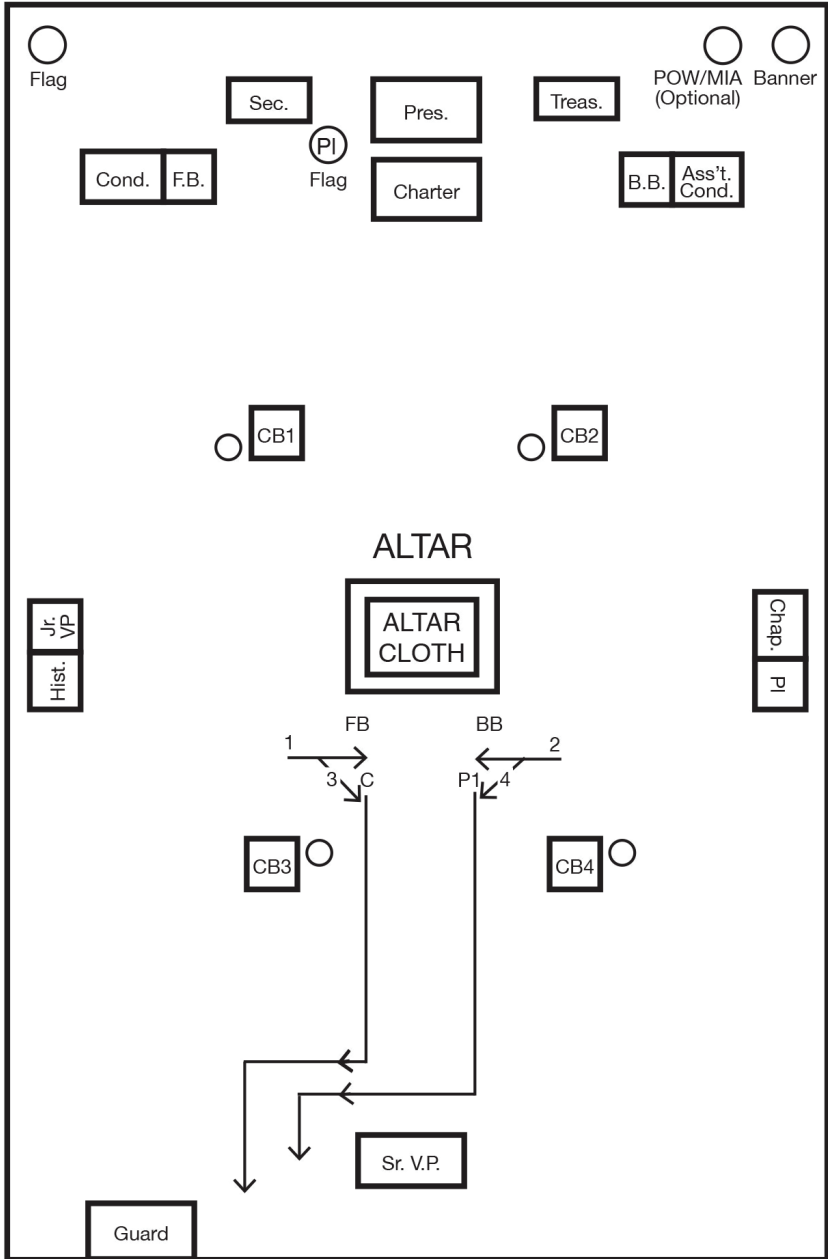

FLOOR PLAN 4

Presenting Colors -- Altar Position

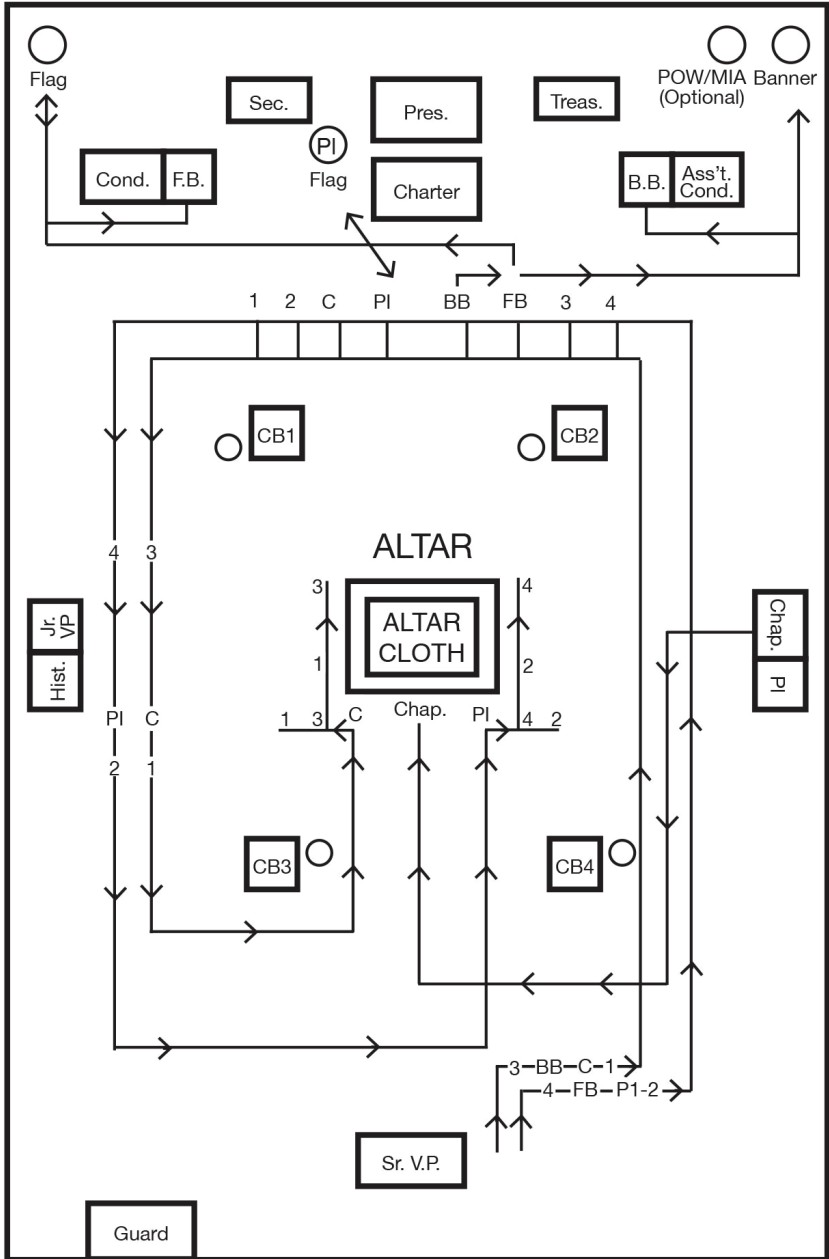

FLOOR PLAN 5

Leaving Altar for Stations

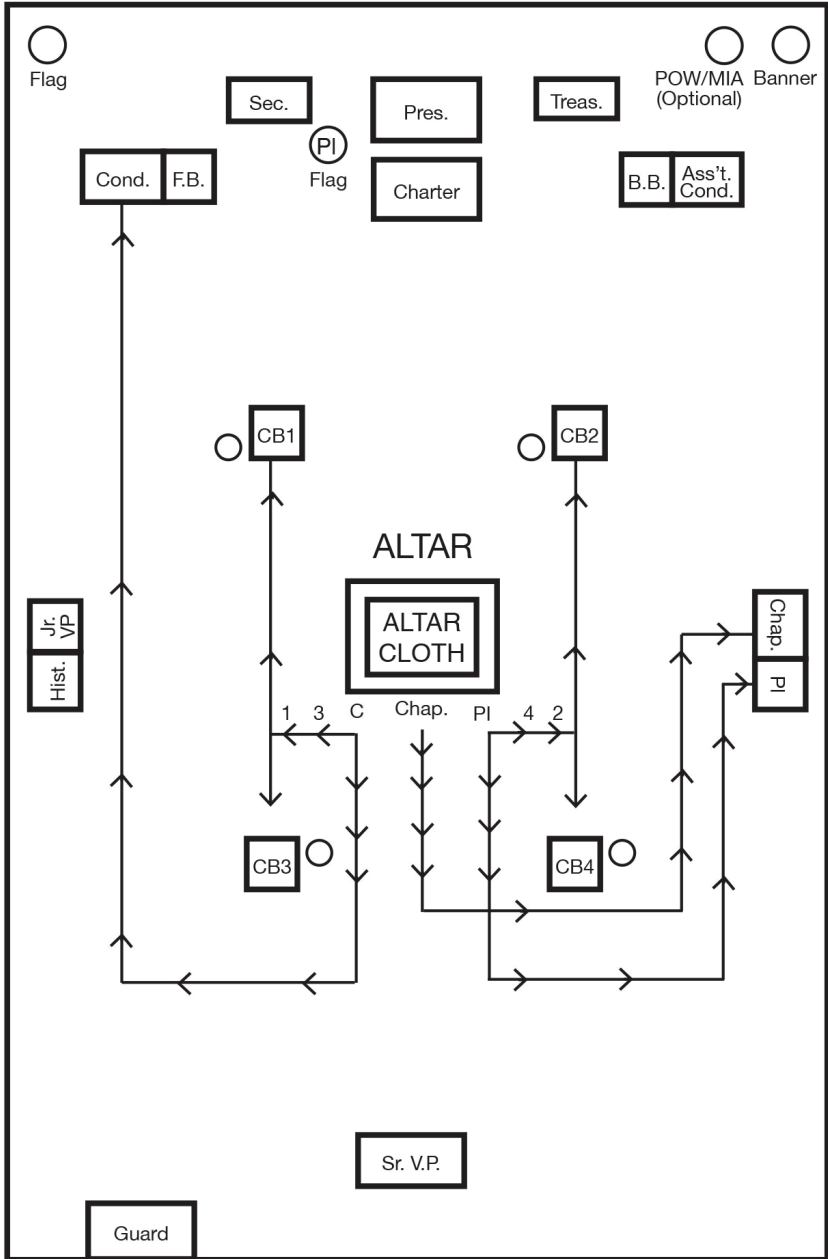

FLOOR PLAN 6

Closing Retiring of Colors

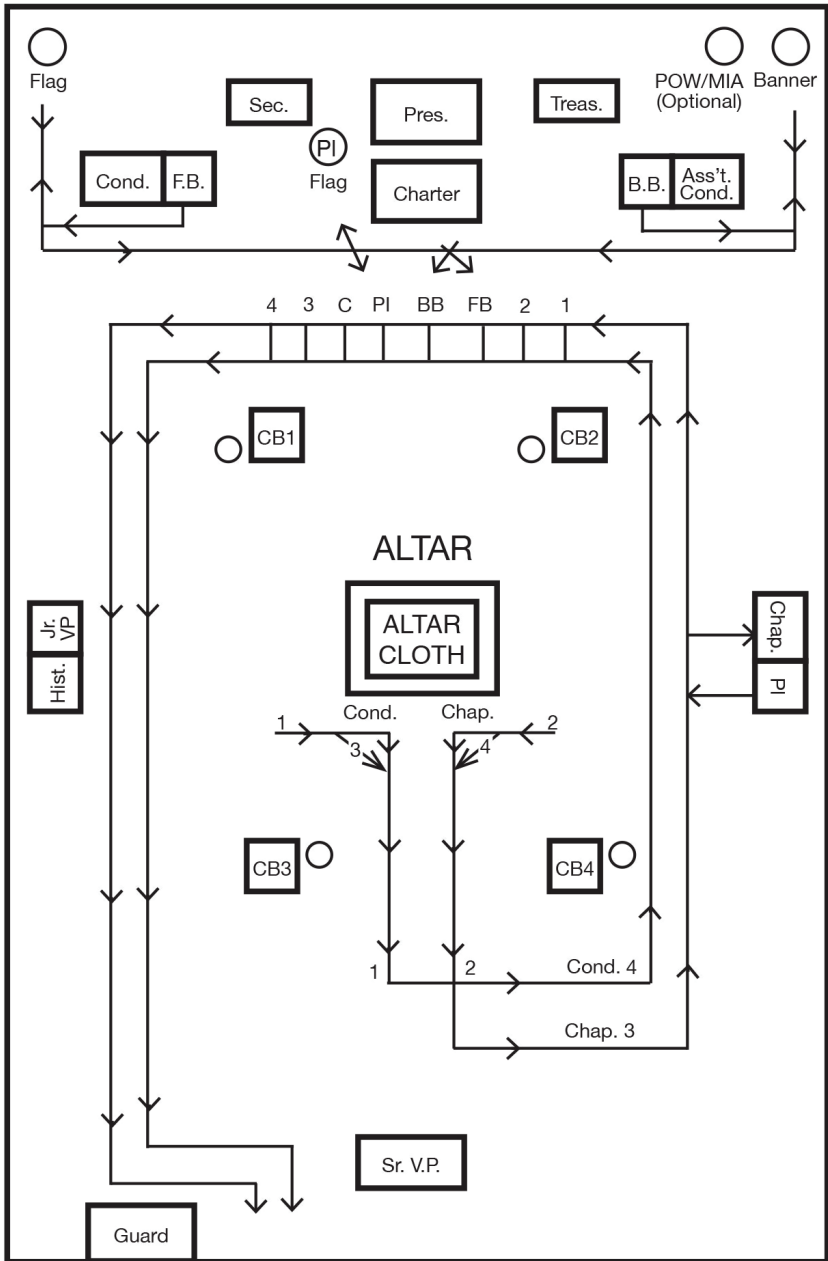

FLOOR PLAN 7

INITIATION: Presenting Candidate(s) at Altar
 Chaplain's Obligation-Altar Position-Sr. Vice-President,
 Jr. Vice-President and President's Charges.

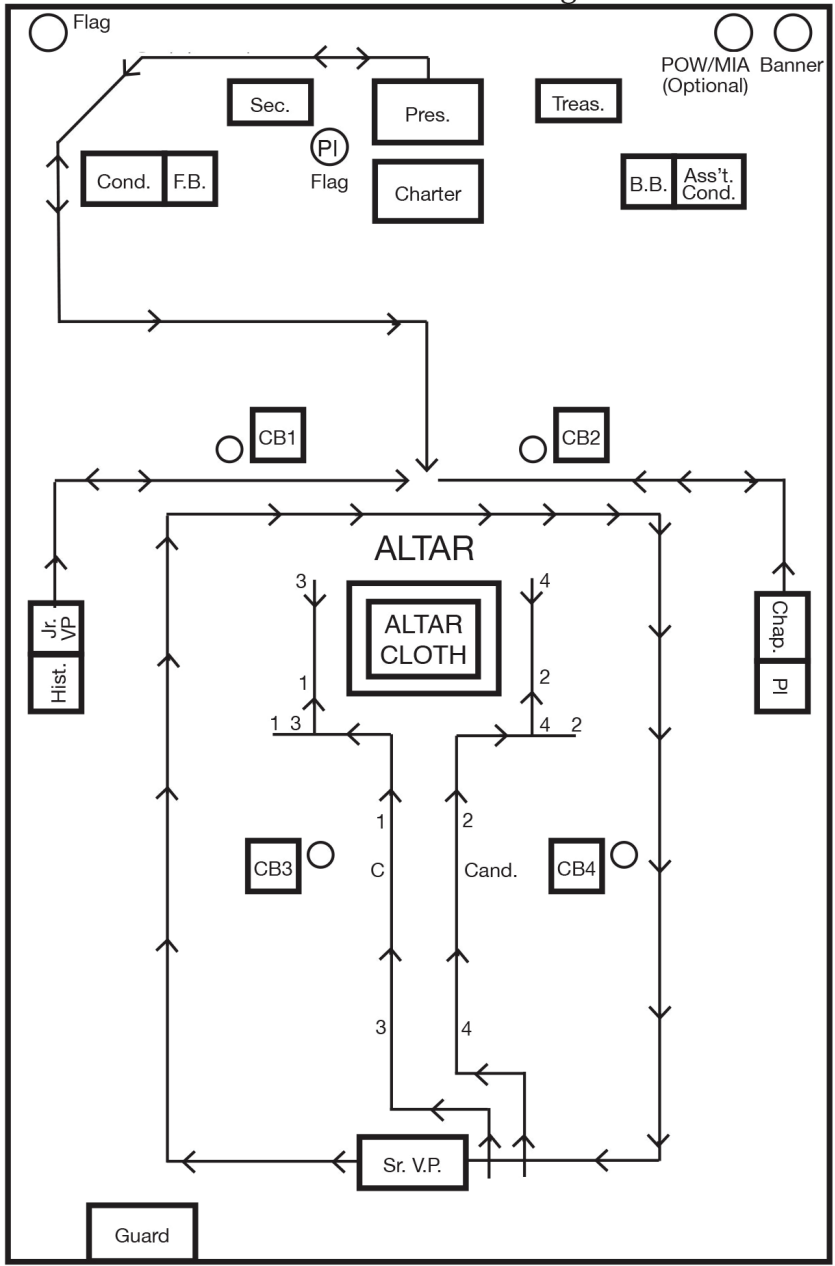

FLOOR PLAN 8

Draping of the Charter

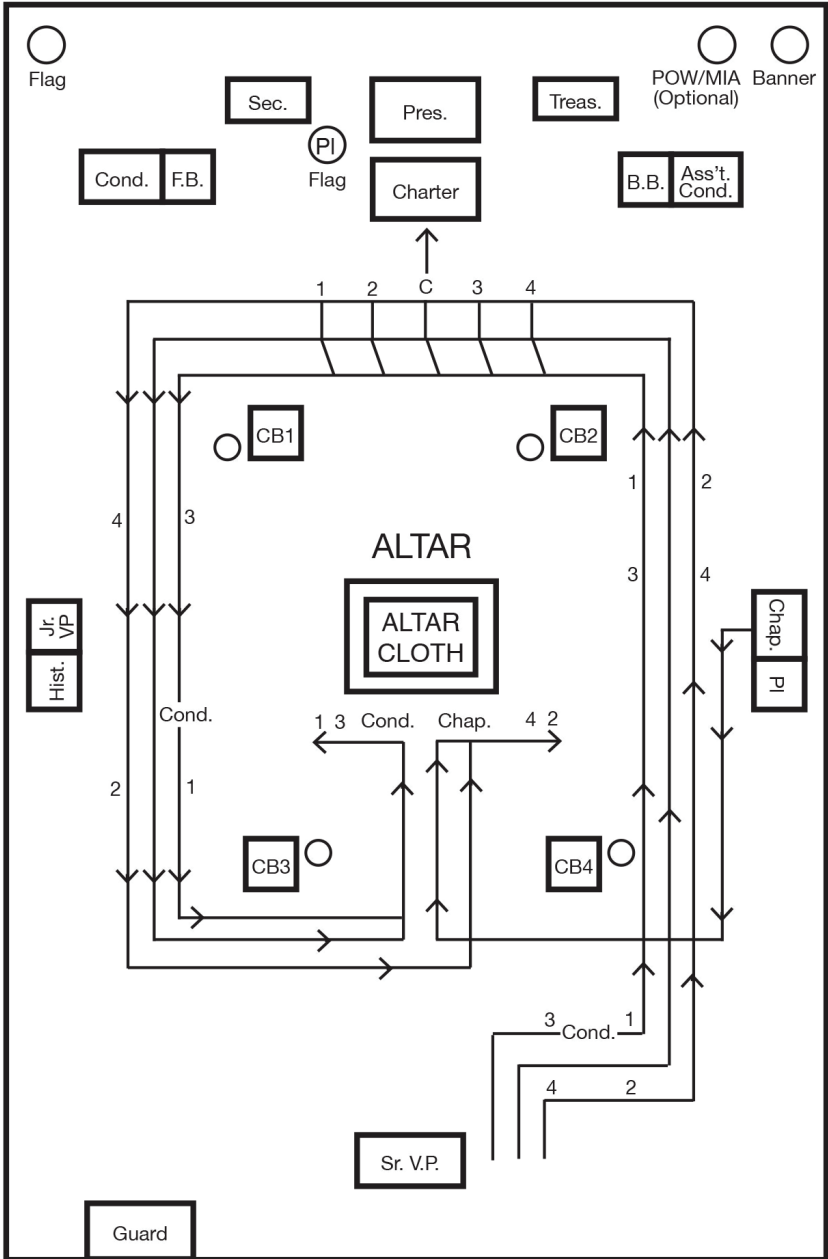

FLOOR PLAN 9

Memorial Service

Retiring for Altar Cloth

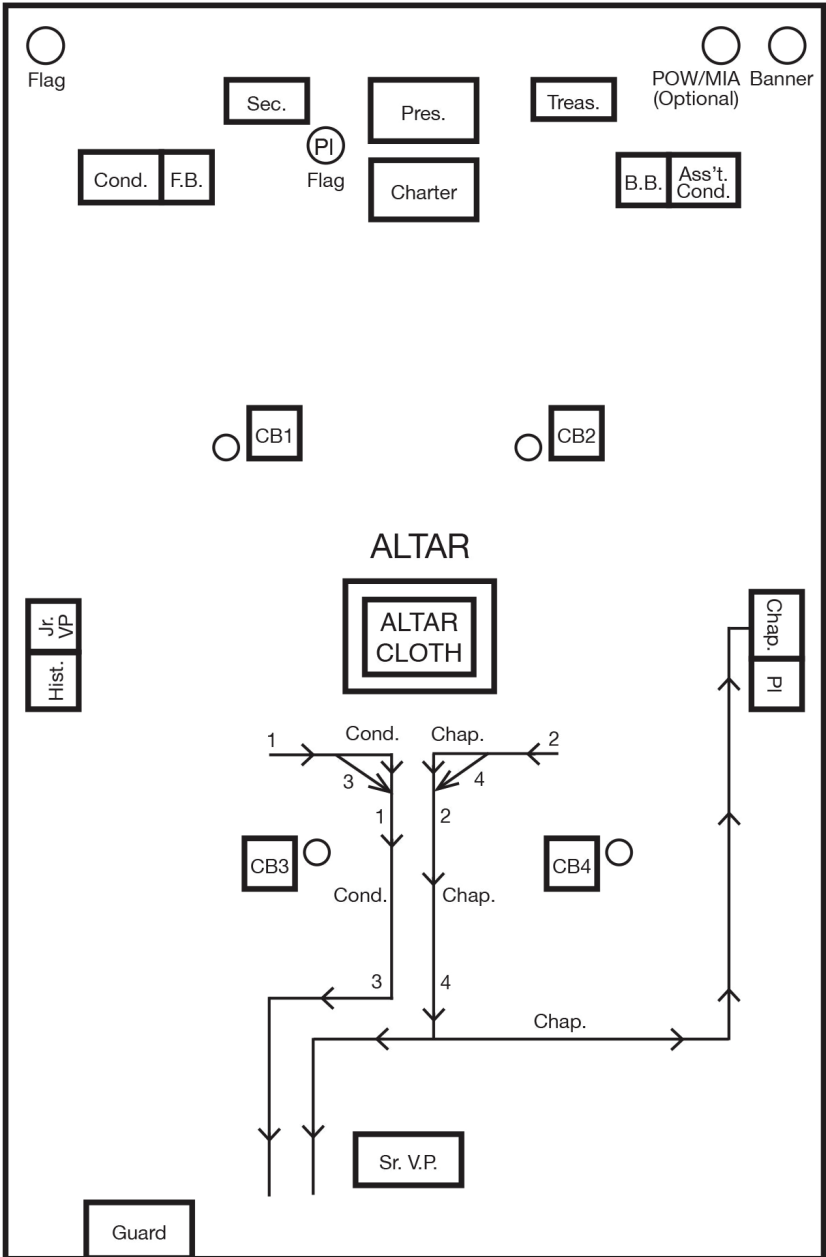

FLOOR PLAN 10

Memorial Service

Draping Altar

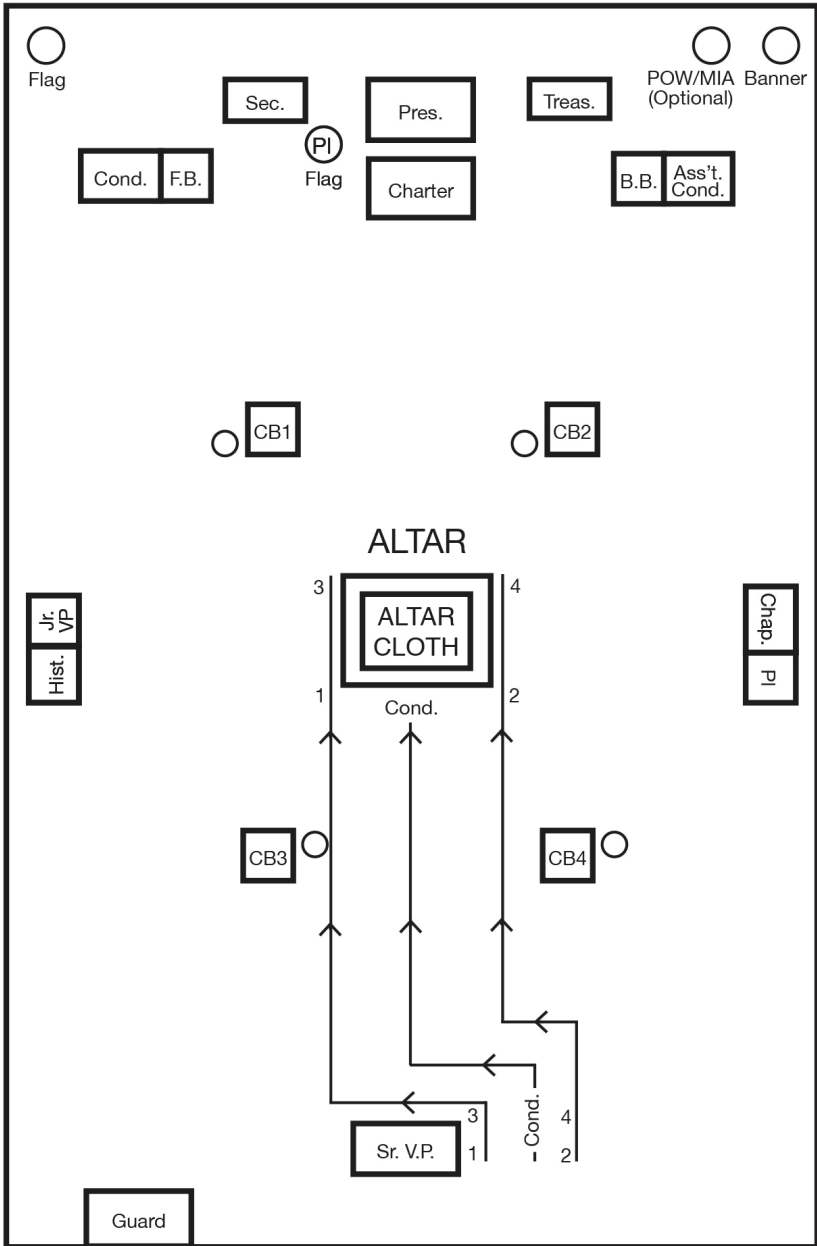

FLOOR PLAN 10A

Memorial Service - Cont.

Draping Altar

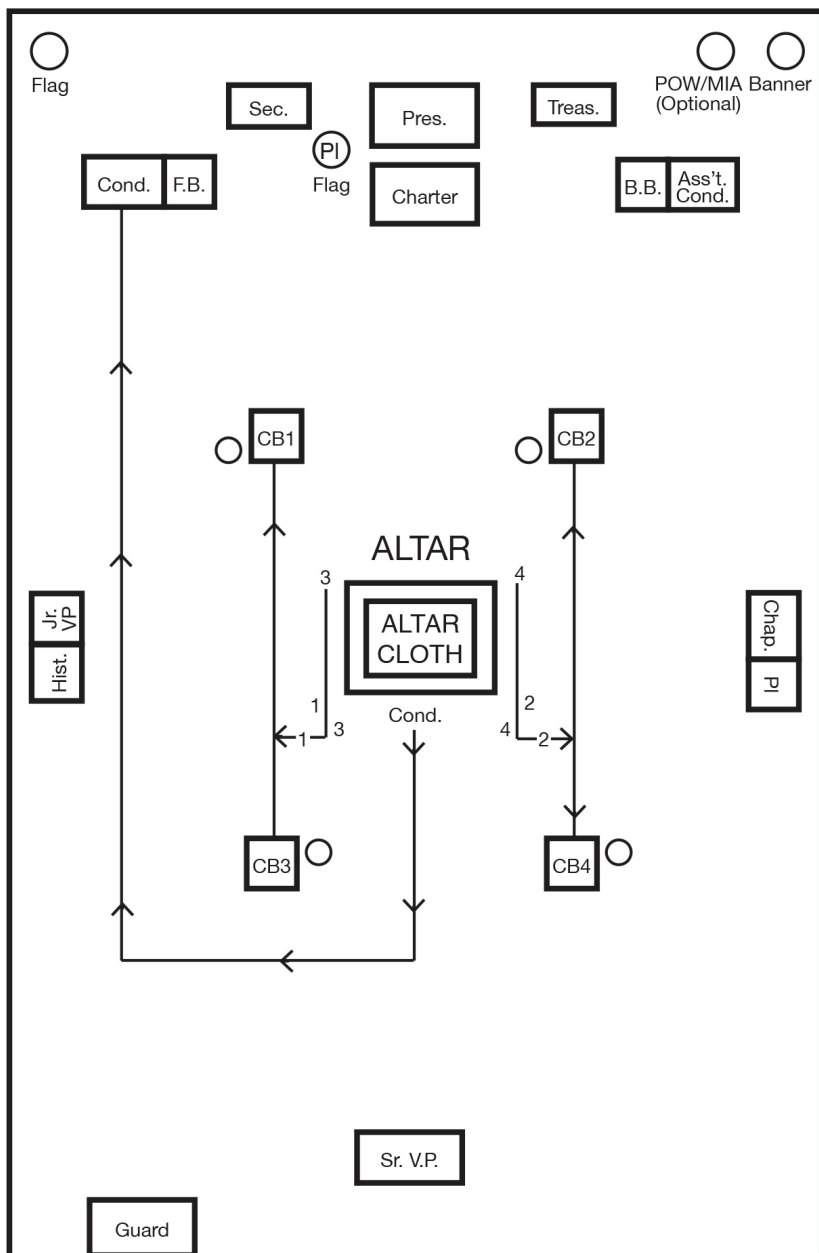

FLOOR PLAN 10B

Memorial Service - Cont.

President advancing to Altar

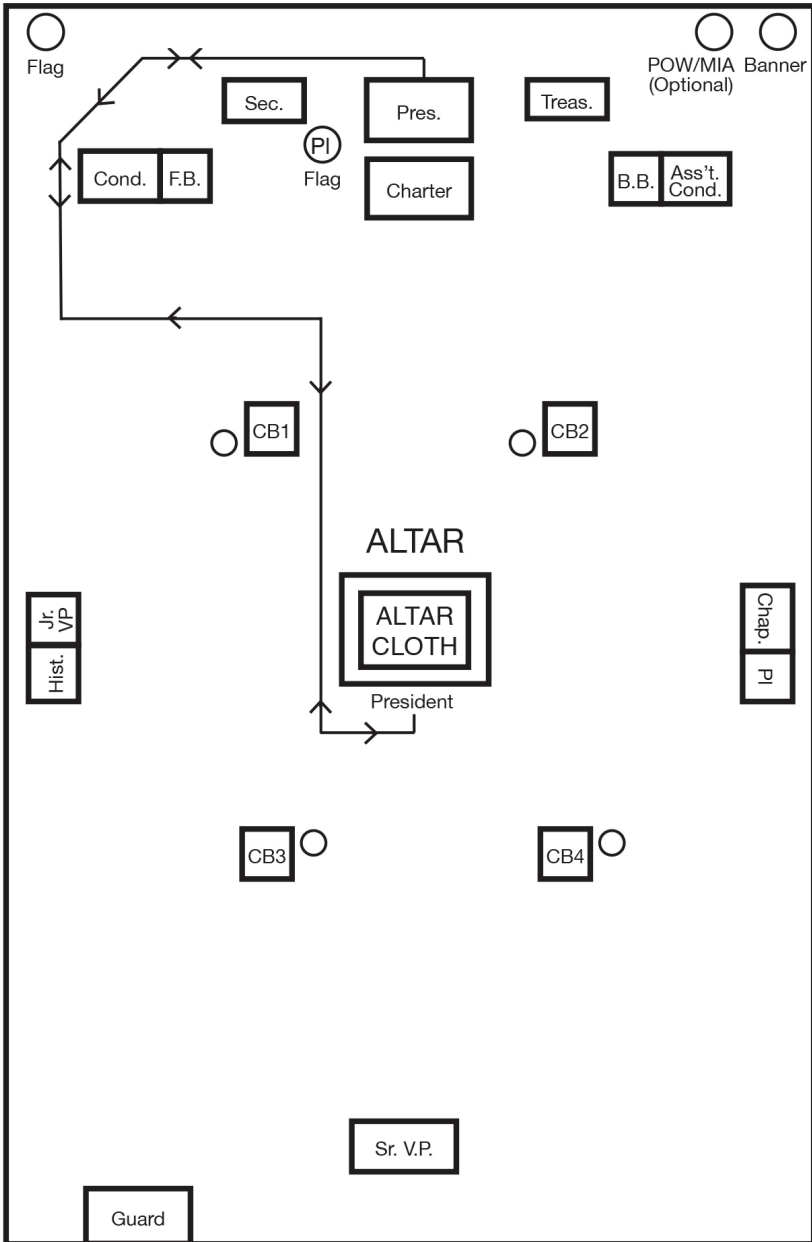

FLOOR PLAN 11

Retiring Memorial Altar Cloth Approach to Altar

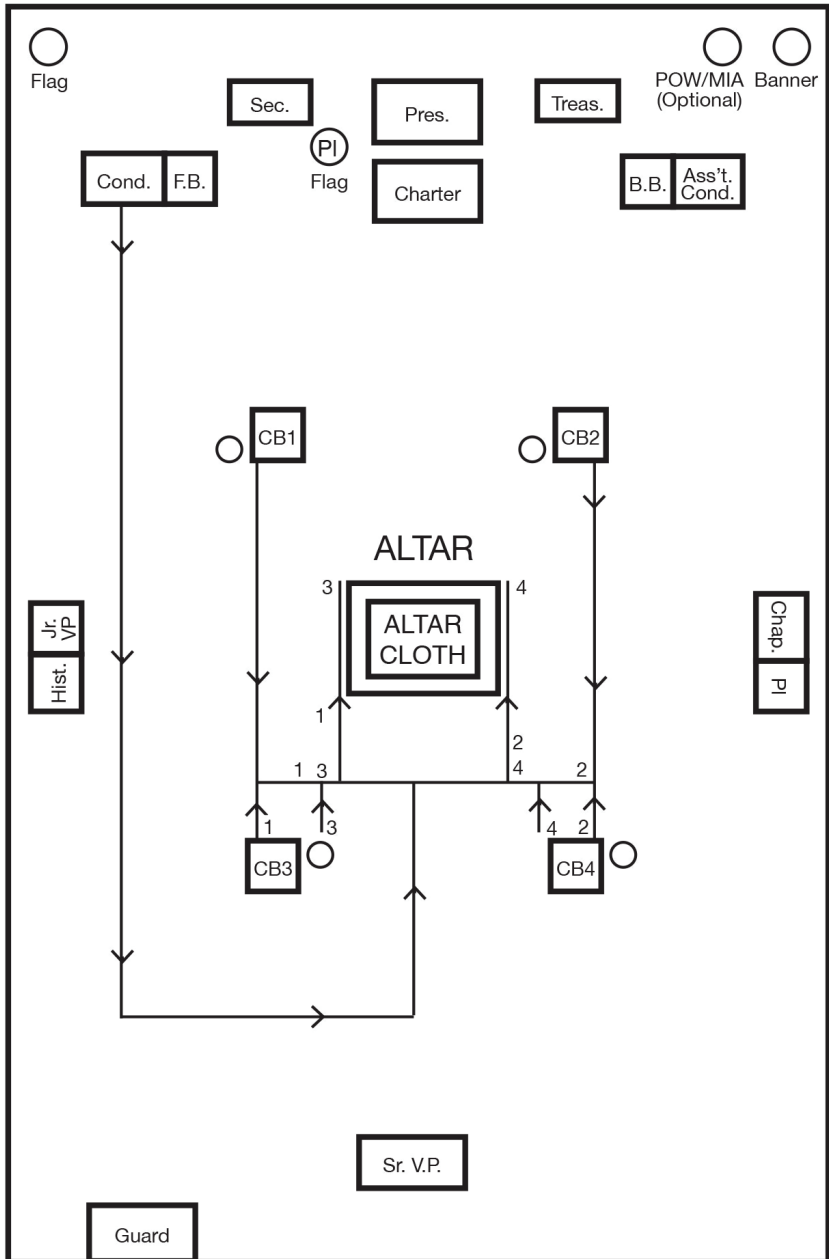

FLOOR PLAN 12

Retiring Memorial Altar Cloth

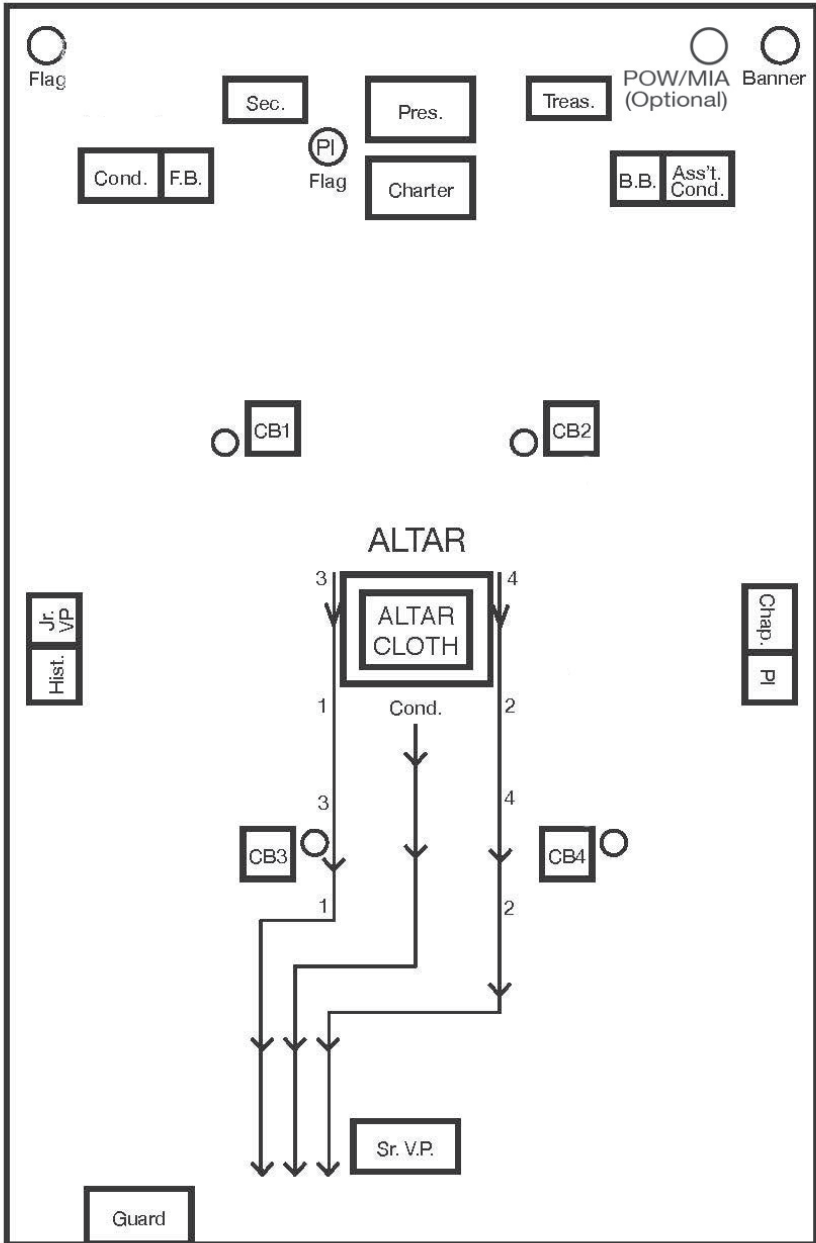

FLOOR PLAN 13

Re-entering room with colors following Memorial Service

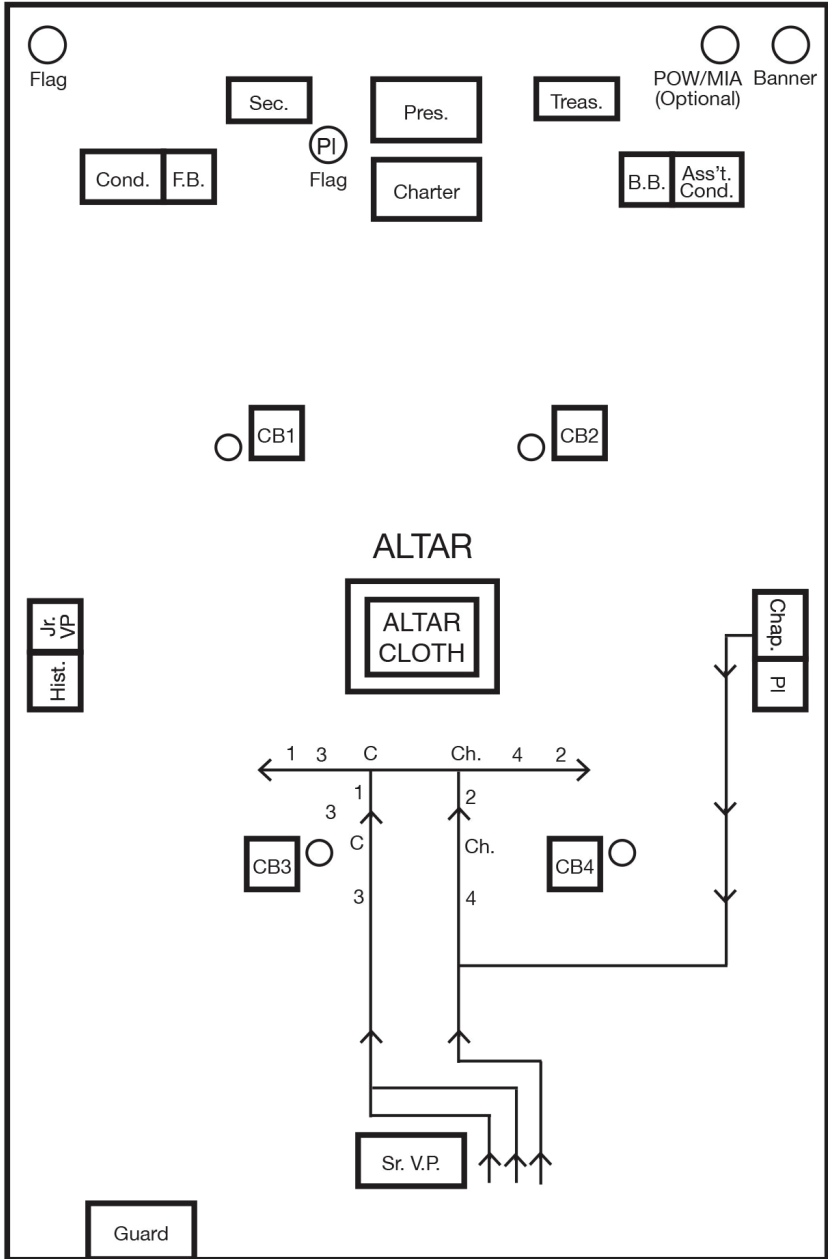

FLOOR PLAN 14

Presenting Commander-in-Chief or National President

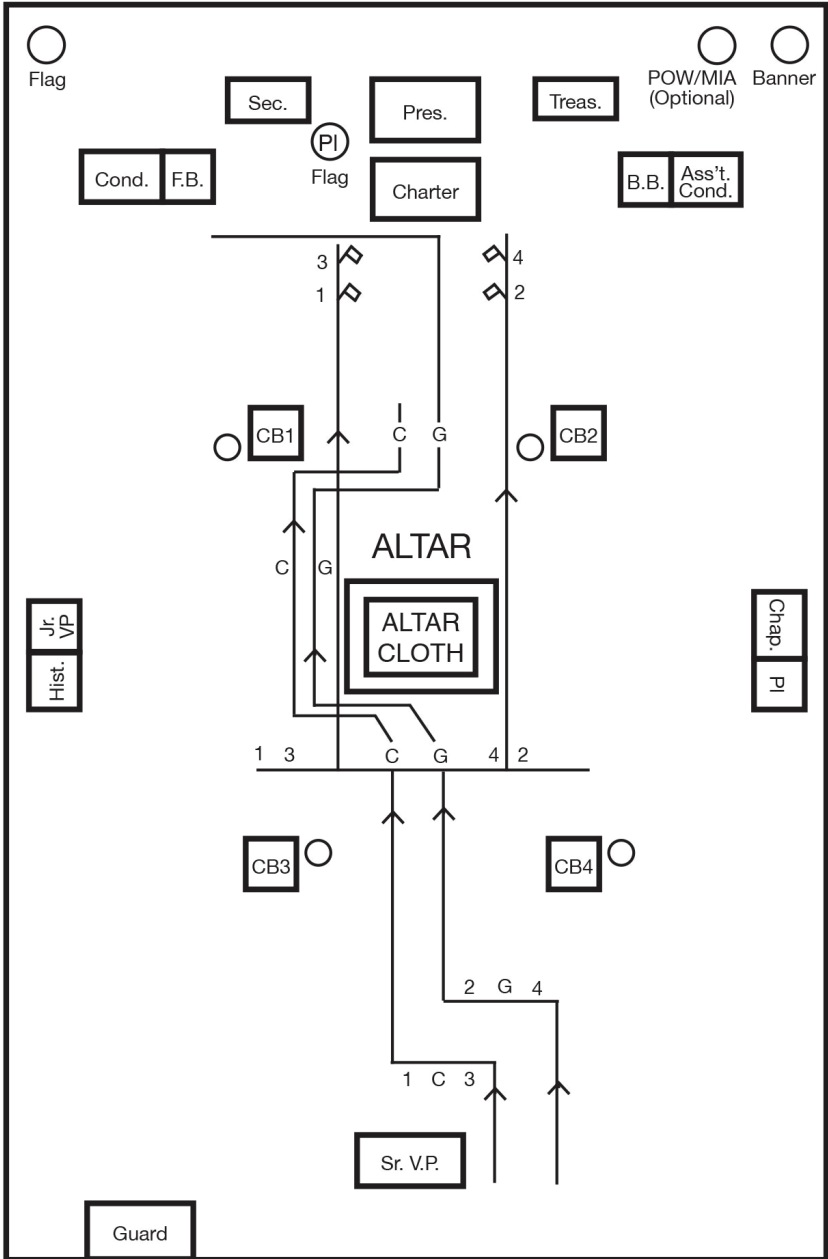

FLOOR PLAN 15

Escorting Guest to President's Station

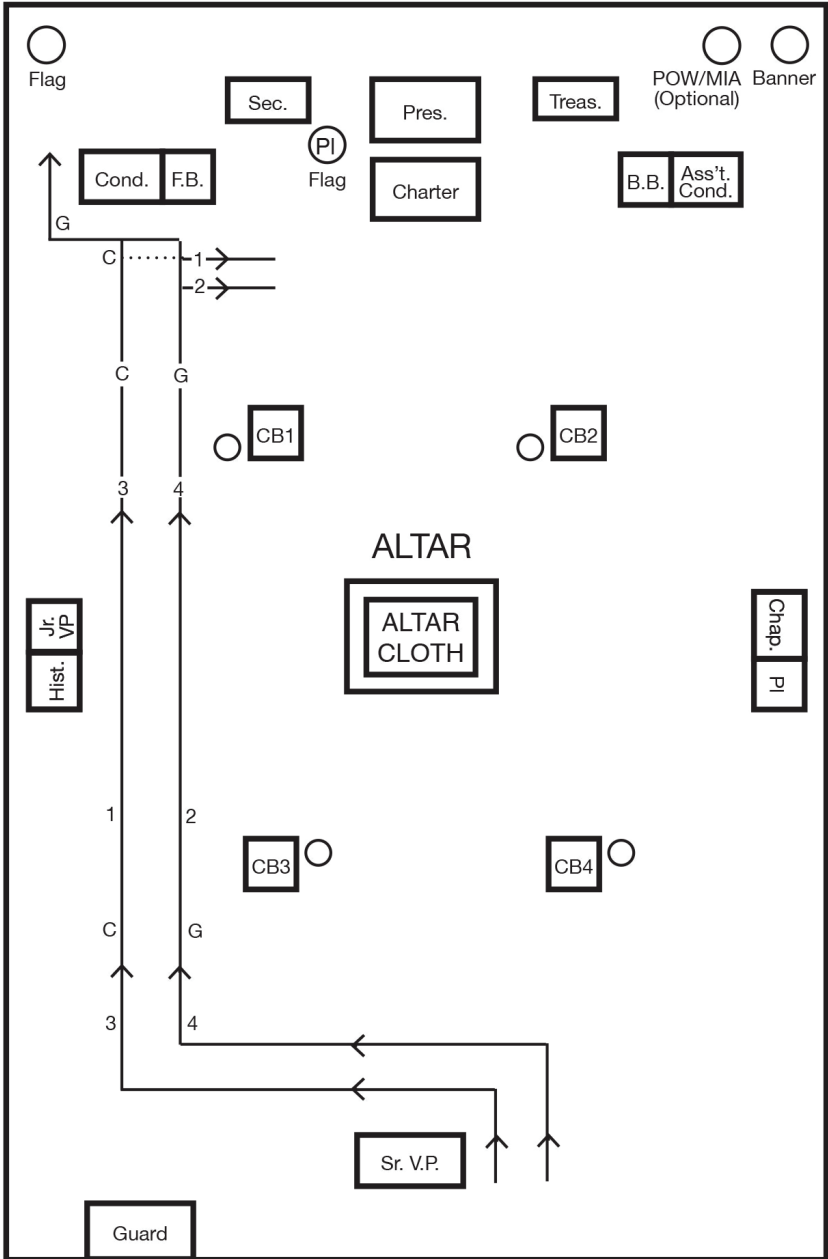

FLOOR PLAN 15A

Escorting Guests to President's Station

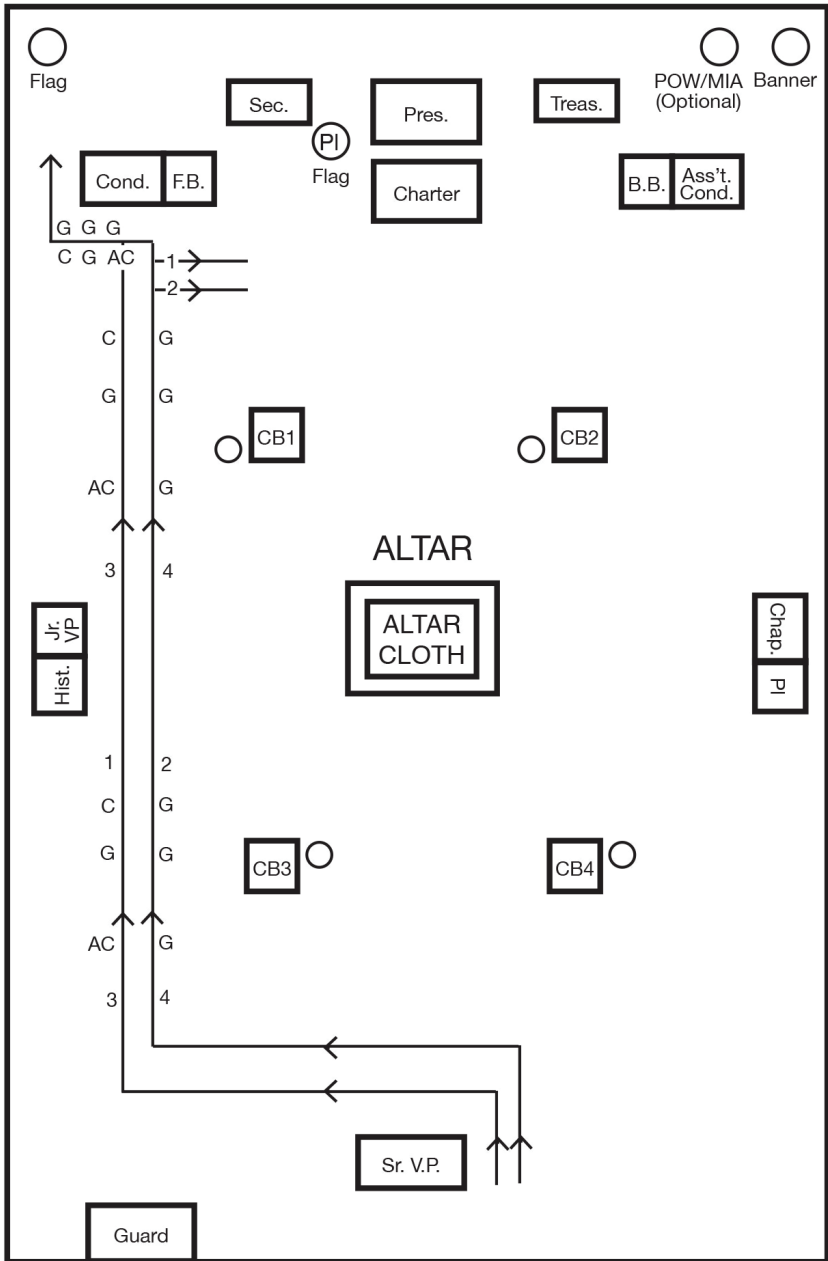

FLOOR PLAN 16

Returning to Altar after Escorting Guest to President's Station

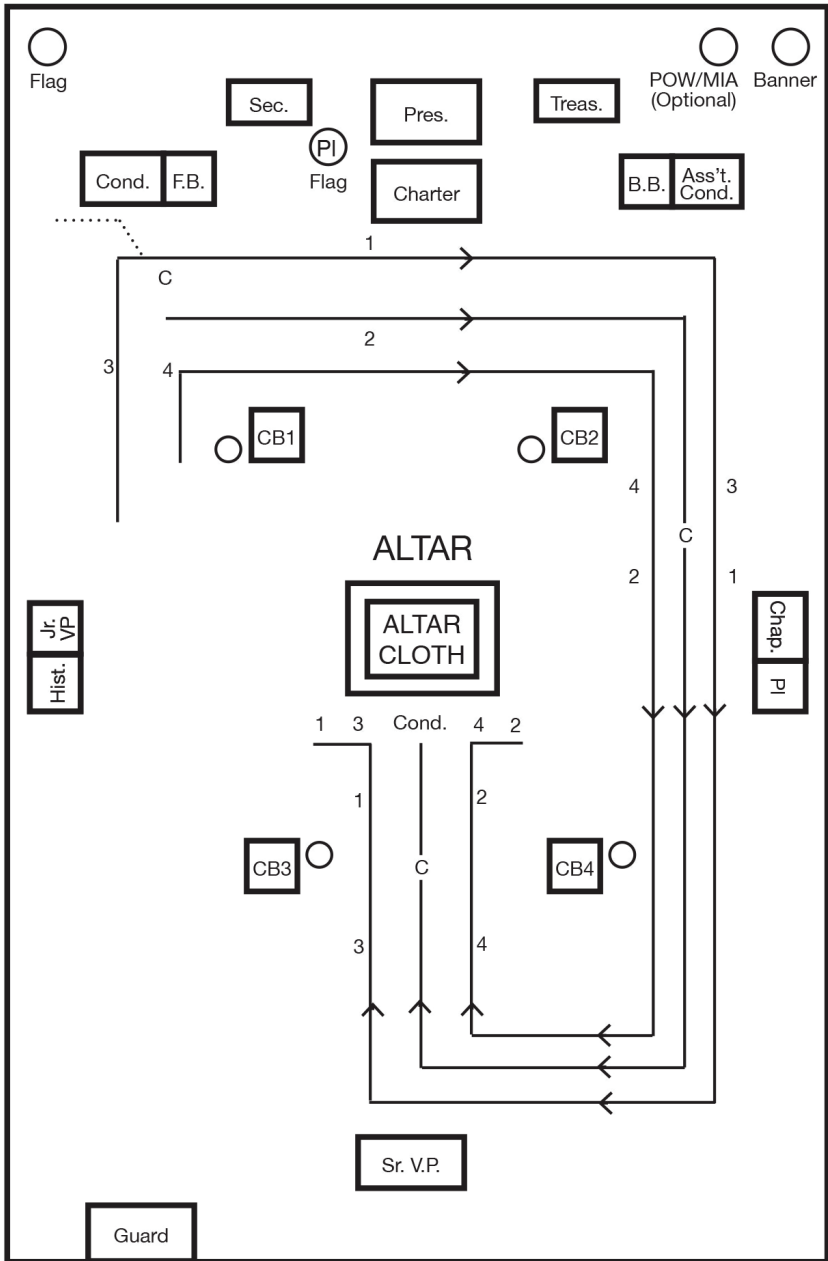

FLOOR PLAN 16A

Returning to Altar after Escorting Guests to President's Station

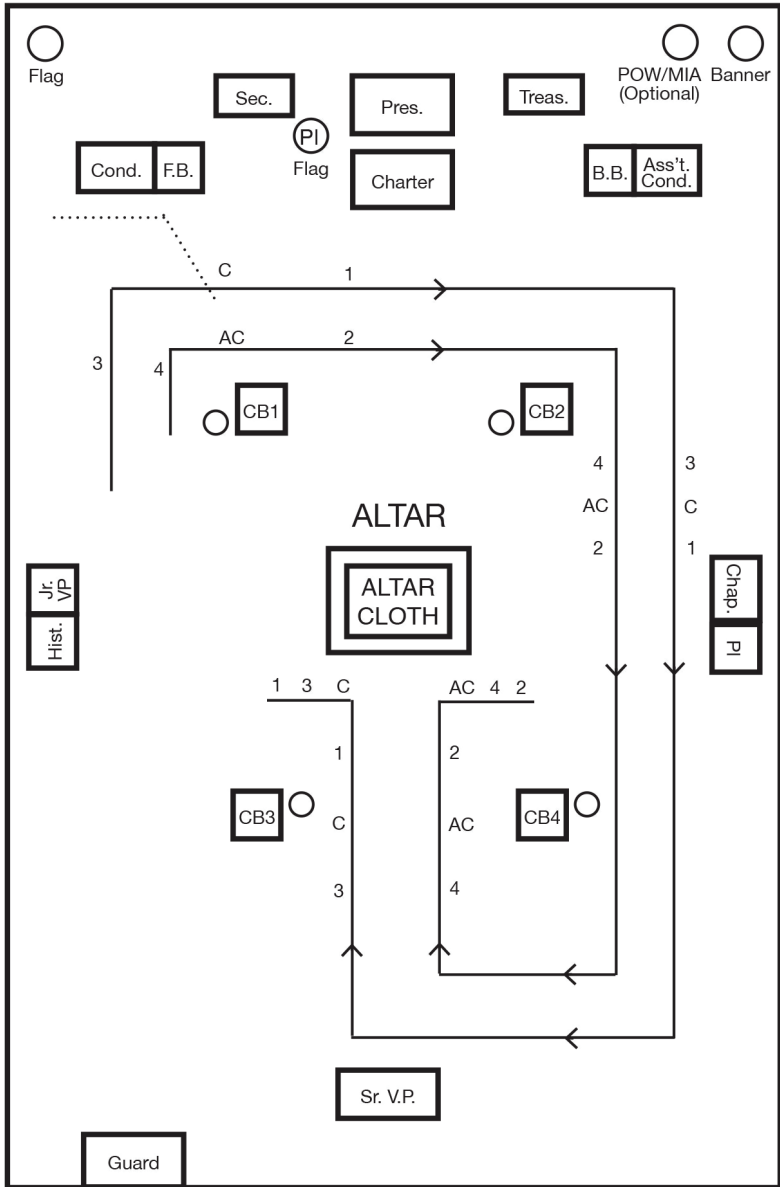

FLOOR PLAN 17

Escorting Guest from President's Station with the Colors

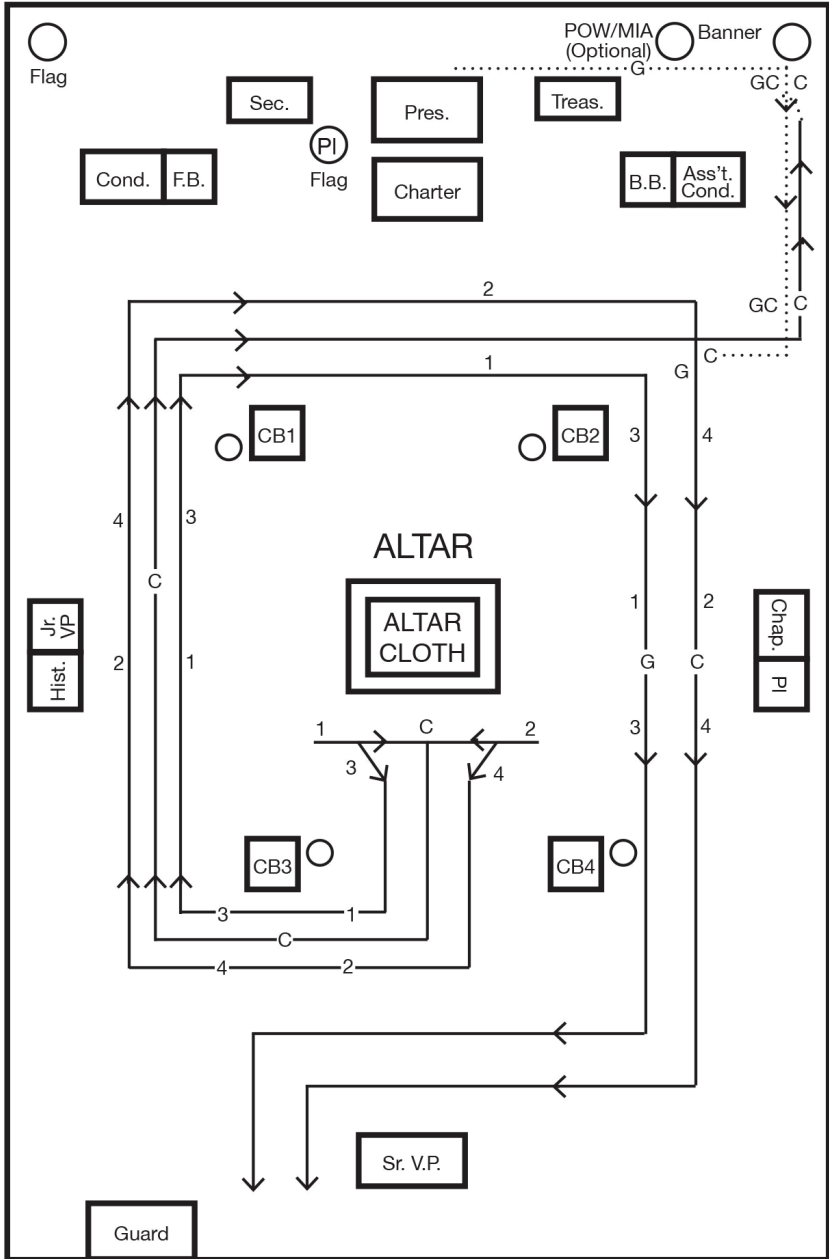

FLOOR PLAN 17A

Escorting Guest(s) from President's Station with the Colors

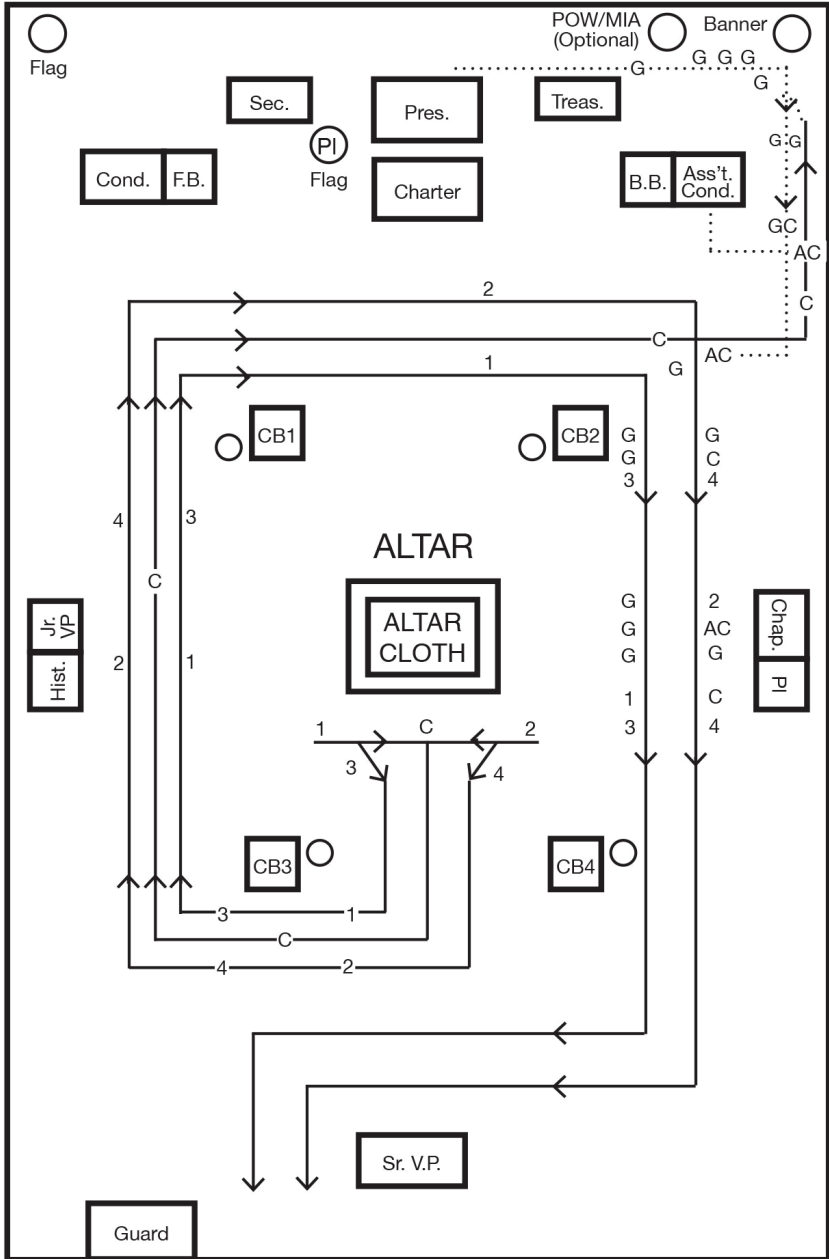

FLOOR PLAN 18

Escorting Guest(s) from President's Station without the Colors

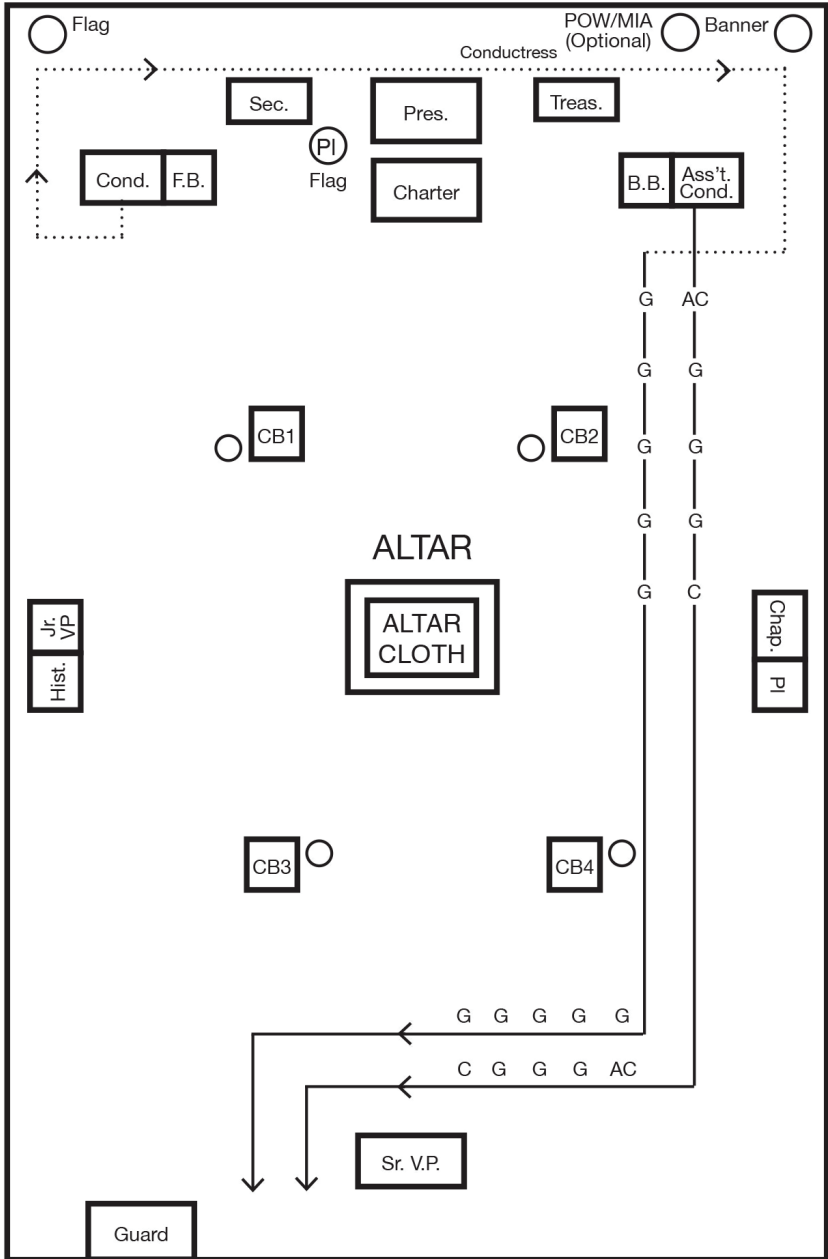

NOTES

